

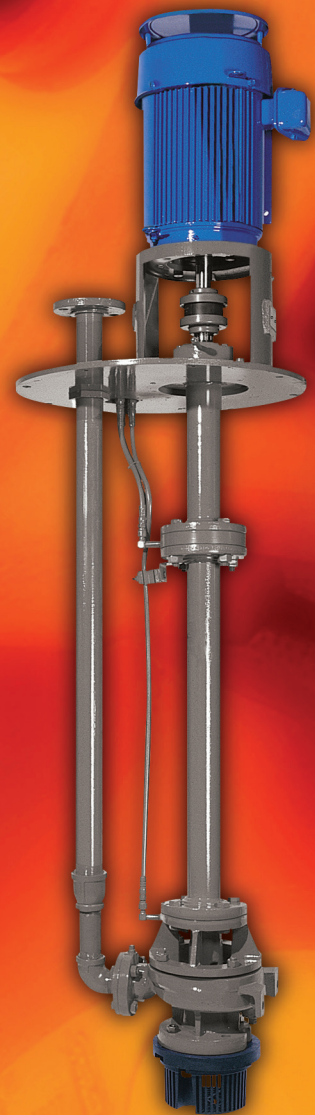

Durco[®] ESP3
Vertical Immersion Sump Pump

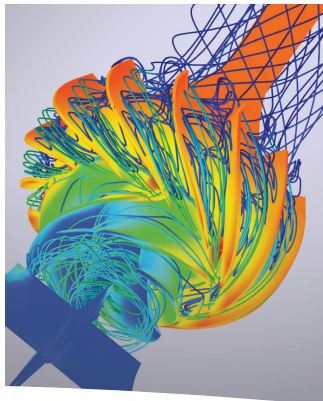

Experience In Motion

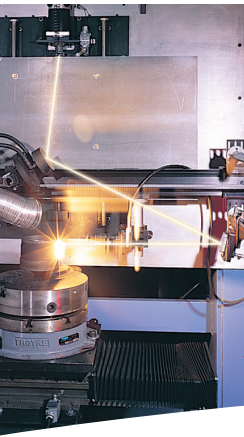

Pump Supplier to the World

Flowserve is the driving force in the global industrial pump marketplace. No other pump company in the world has the depth or breadth of expertise in the successful application of pre-engineered, engineered, and special purpose pumps and systems.

Life Cycle Cost Solutions

Flowserve is providing pumping solutions which permit customers to reduce total life cycle costs and improve productivity, profitability and pumping system reliability.

Market-Focused Customer Support

Product and industry specialists develop effective proposals and solutions directed toward market and customer preferences. They offer technical advice and assistance throughout each stage of the product life cycle, beginning with the initial inquiry.

Broad Product Lines

Flowserve offers a wide range of complementary pump types, from pre-engineered process pumps, to highly engineered and special purpose pumps and systems. Pumps are built to recognized global standards and customer specifications.

Pump designs include:

- Single-stage process
- Between bearings single-stage
- Between bearings multistage
- Vertical
- Submersible motor
- Positive displacement
- Nuclear
- Specialty

Product Brands of Distinction

ACEC™ Centrifugal Pumps

Aldrich™ Pumps

Byron Jackson® Pumps

Calder™ Energy Recovery Devices

Cameron™ Pumps

Durco® Process Pumps

Flowserve® Pumps

IDP® Pumps

INNOMAG® Sealless Pumps

Lawrence Pumps®

Niigata Worthington™ Pumps

Pacific® Pumps

Pleuger® Pumps

Scienco™ Pumps

Sier-Bath® Rotary Pumps

TKL™ Pumps

United Centrifugal® Pumps

Western Land Roller™ Irrigation Pumps

Wilson-Snyder® Pumps

Worthington® Pumps

Worthington Simpson™ Pumps

**Durco ESP3
Vertical Immersion
Sump Pump**



Complementary Pumps

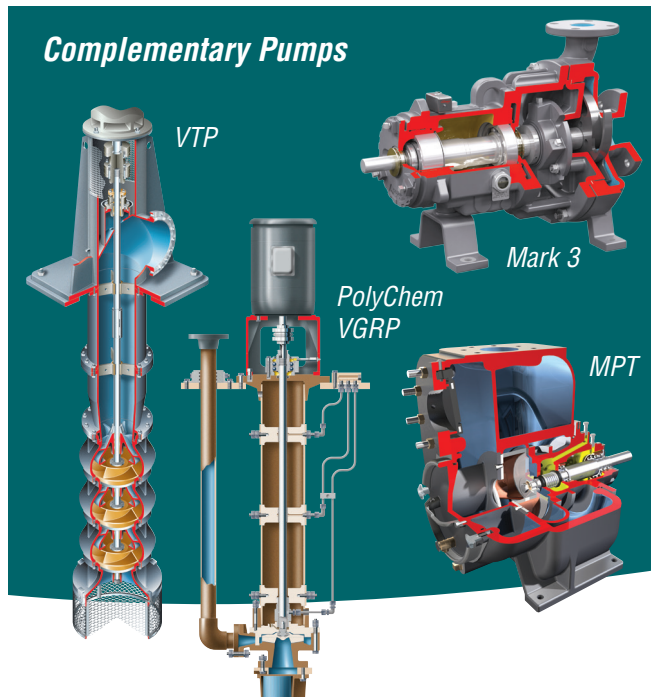

**Engineered and Built for
Low Total Cost of Ownership**

Boasting the same casing, reverse vane impeller and CBL cover as the industry-leading Durco Mark 3™ chemical process pump, the ESP3 is ruggedly built to handle tough applications. It is the only vertical wet-pit immersion sump pump to offer parts interchangeability with standard ASME B73.1 horizontal pumps. The upshot is increased parts standardization and reduced inventory costs.

The ESP3's many reliability-enhancing features improve performance and efficiency while reducing costs associated with maintenance and downtime. The result is low total cost of pump ownership.



Typical Applications

- Wet-pit
- Effluent
- Water treatment
- Liquid transfer
- Hydrocarbon processing
- Chemical processing
- General industry

Complementary Pump Designs

Depending upon application requirements, Flowserve can also provide the following pumps:

- Durco Mark 3 ISO Self-Priming chemical process pump
- Durco Mark 3 ASME (ANSI) Unitized Self-Priming chemical process pump
- FRBJ vertical cantilever sump pump
- MJ hard metal, vertical lineshaft pump
- MPT self-priming, solids-handling pump
- PolyChem™ VGRP non-metallic vertical sump pump
- RJ rubber-lined, vertical lineshaft pump
- VTP vertical turbine pump
- VPC vertical turbine, double-casing pump

Durco ESP3

Vertical Immersion Sump Pump

The ESP3 vertical immersion sump pump delivers extended pump life over a wide range of applications in chemical and hydrocarbon processing. It is available in many corrosion-resistant materials and with a broad range of options, enabling customers to tailor the pump to site-specific requirements.

Operating Parameters

- Flows to 1300 m³/h (5700 gpm)
- Heads to 90 m (300 ft)
- Pressures to 12 bar (175 psi)
- Temperatures to 180°C (350°F)
- Pit depths to 6 m (20 ft); greater depths achievable with optional tailpipe

Features and Benefits

ASME B73.1 Standard Casing Design is offered in a wide range of materials, including abrasion-resistant high chrome iron, to suit application requirements.

One-piece, Heavy-duty Shaft is ground to a high finish and designed, along with the bearing sizes and API compliant spacing, to produce the highest critical speeds available.

Standard Reverse Vane Impeller offers repeatable performance throughout the life of the pump. And, since liquid exits the back of a reverse vane impeller, wear occurs on the cover instead of the expensive casing. Open impellers are available for stringy or fibrous liquids.

Bearings are properly located to eliminate shaft whip. To suit application requirements, duplex angular contact thrust bearings are mounted externally and sized to handle all pump axial thrust. Radial lineshaft bearings, carbon standard, are also available in low-cost bronze, fluted rubber as well as abrasion-resistant PEEK® and corrosion-resistant PTFE.

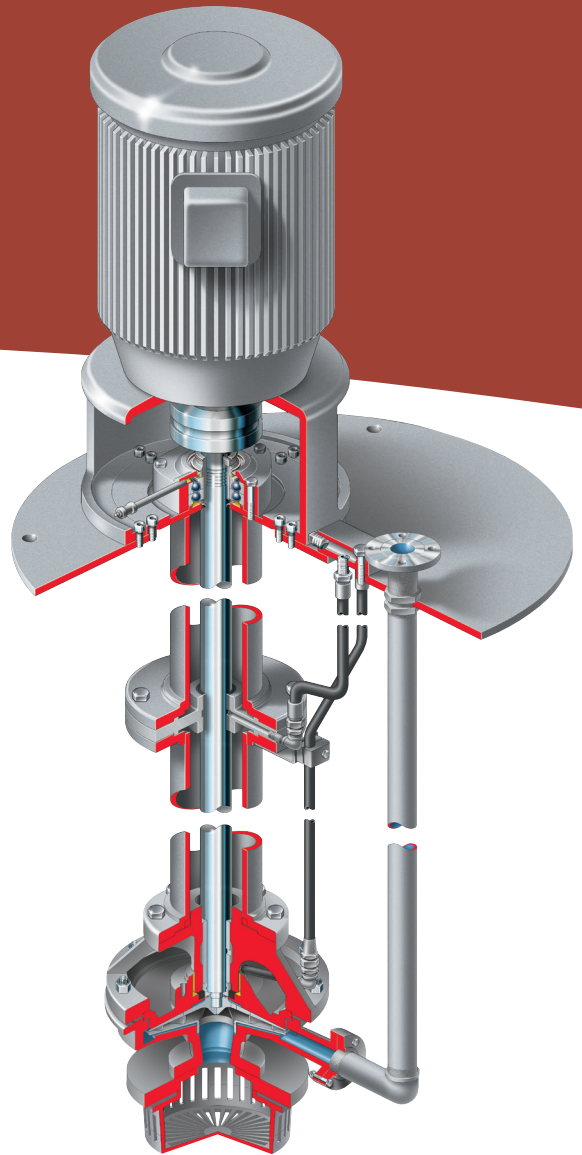

T.B. Woods Sure-Flex® Couplings are precision machined and self-aligning.

Large Polypropylene Basket Strainer resists corrosion. Up to four times larger than the impeller eye, the oversized basket lowers velocities and improves suction performance. Metal strainer available.

Factory Flanged Discharge simplifies field piping and is available in a variety of configurations.

Lubrication System Options

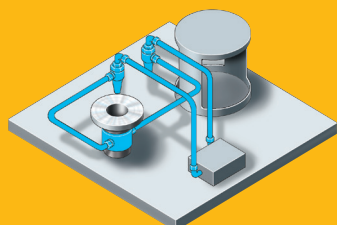

Dual Particle Separation System

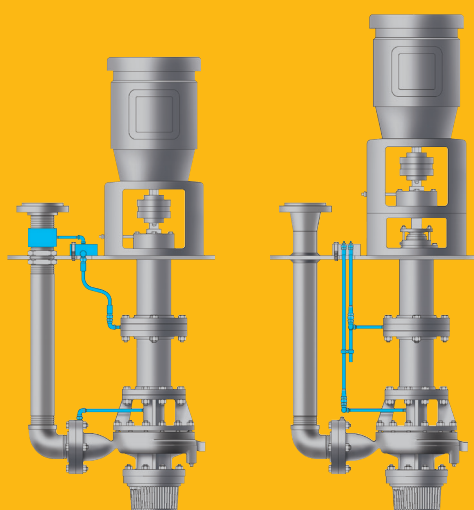

Product

Grease



Automatic Grease

Multiple Lubrication Options

Several lubrication systems are available, including:

- Product lubrication – for clean liquids
- Manual or automatic grease lubrication – for pumped fluids possessing poor lubricity or containing solids
- Dual particle separation – for applications requiring the removal of small amounts of solids

Available Low-Flow and Recessed Impeller Configurations

ESP3 Lo-Flo™: Designed to improve pump reliability and performance in low-flow, high head applications, the ESP3 Lo-Flo pump features the same radial vane impeller and circular, concentric casing as the Durco Mark 3 Lo-Flo™ pump. This innovative design reduces radial loads and shaft deflection while extending bearing and shaft life.



ESP3 Recessed Impeller:

With its circular volute casing and standard duplex stainless steel construction, the ESP3 Recessed Impeller pump uses vortex action to extend service life when handling solid, stringy or fibrous slurries. With less than 20% of media contacting the impeller, abrasive wear is minimized, low shear is obtained and solids integrity maintained.

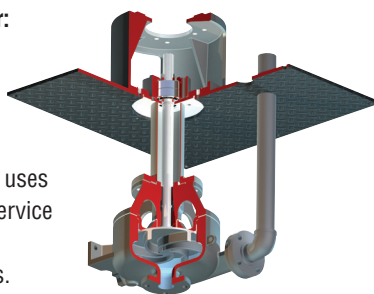

Designed to Lower Installation and Maintenance Costs

The ESP3 incorporates many features designed to reduce costs associated with installation and maintenance:

- Heavy-duty ISO 13709/API 610 compliant lineshaft-shaft bearing design virtually eliminates shaft failure.
- Lineshaft bearing lubrication manifold connects to an external clean lube source with multiple lube lines, terminating in one unit for easy maintenance.
- Extended grease lube fitting simplifies lubrication by eliminating guard removal.
- Industry standard TCV motor allows for quick and accurate alignment.
- Replaceable, non-metallic sealing ring provides means of accurately restoring the original tolerance between the shaft and cover. It also facilitates bearing removal.
- Premium metal-backed, carbon graphite bearings ease installation and increase shaft stability.
- Standard duplex angular contact external thrust bearing eliminates transmission of pump-developed loads to the motor, preventing costly motor bearing failures.
- Precision machined, metal-to-metal, inter-connecting faces at the casing, seal chamber and adapter housing provide total concentricity.
- Simplex or duplex mounting arrangements permit site-specific customization for low installation costs.

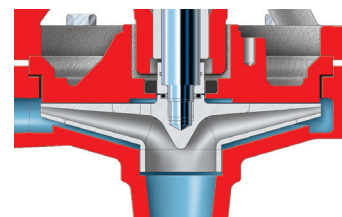

Options and Technical Data

Mounting Plate Options

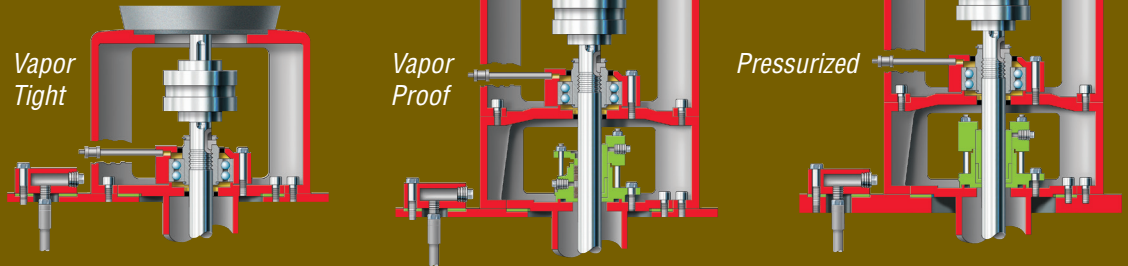

Mounting Plate Options

Three optional mounting plate constructions are offered with the ESP3. They are:

- Vapor tight – uses a standard lip seal
- Vapor proof
 - Withstands 0.34 bar (5 psi) differential pressure
 - Available packed or mechanically sealed
- Pressurized
 - Recommended for hazardous and flammable liquids
 - Withstands 3.4 bar (50 psi) differential pressure
 - Available with standard or gas-type mechanical seals

Customizable Level Controls and Monitors

Flowserve offers a wide range of customizable liquid level controls and monitors with the ESP3. Available models range from on/off mechanically actuated switches to multi-pump displacer types.

Available Suction Tailpipes

Suction tailpipes can be provided for sump depths greater than the maximum pump length or where it is desirable to reduce the pump length.

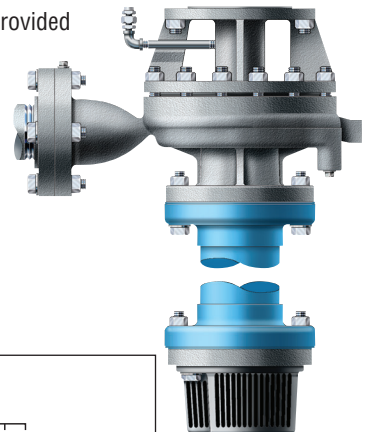

Optional Upper Stuffing Box

The ESP3 can be fitted with an upper stuffing box to prevent vapors from escaping to the atmosphere. Available with soft packing or mechanical seal.

ESP3 Range Chart

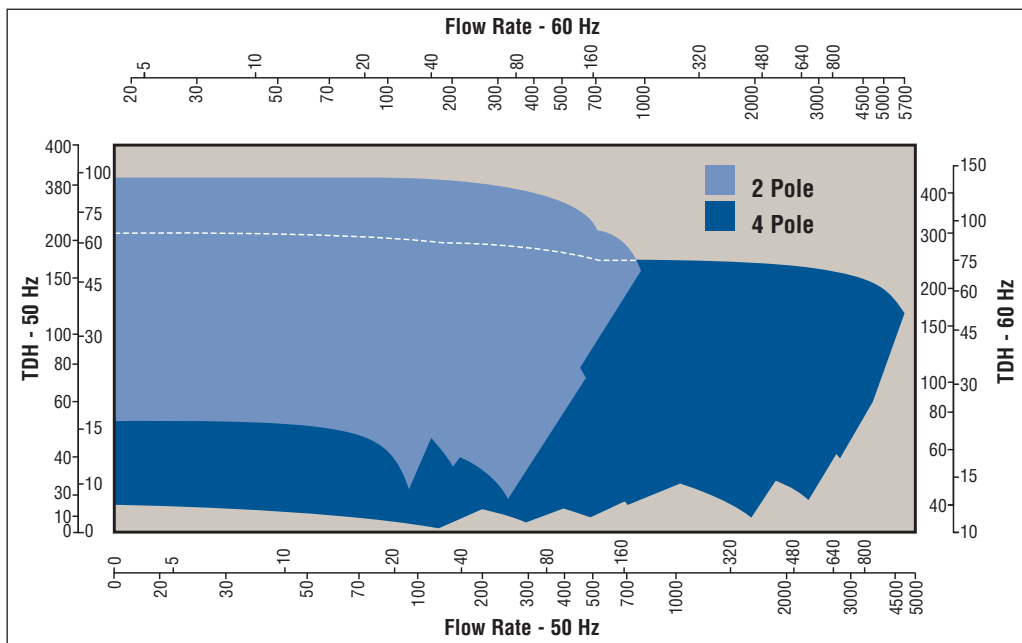

**Global Service
and Technical
Support**

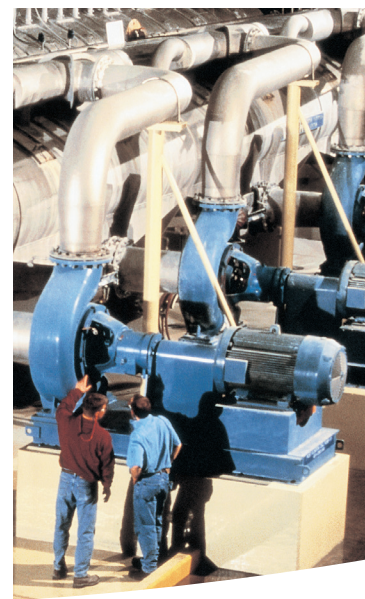
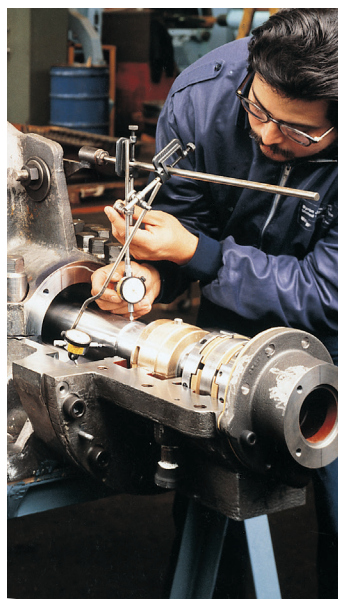

Life Cycle Cost Solutions

Typically, 90% of the total life cycle cost (LCC) of a pumping system is accumulated after the equipment is purchased and installed. Flowserve has developed a comprehensive suite of solutions aimed at providing customers with unprecedented value and cost savings throughout the life span of the pumping system. These solutions account for every facet of life cycle cost, including:

Capital Expenses

- Initial purchase
- Installation

Operating Expenses

- Energy consumption
- Maintenance
- Production losses
- Environmental
- Inventory
- Operating
- Removal

Innovative Life Cycle Cost Solutions

- New Pump Selection
- Turnkey Engineering and Field Service
- Energy Management
- Pump Availability
- Proactive Maintenance
- Inventory Management

Typical Pump Life Cycle Costs¹

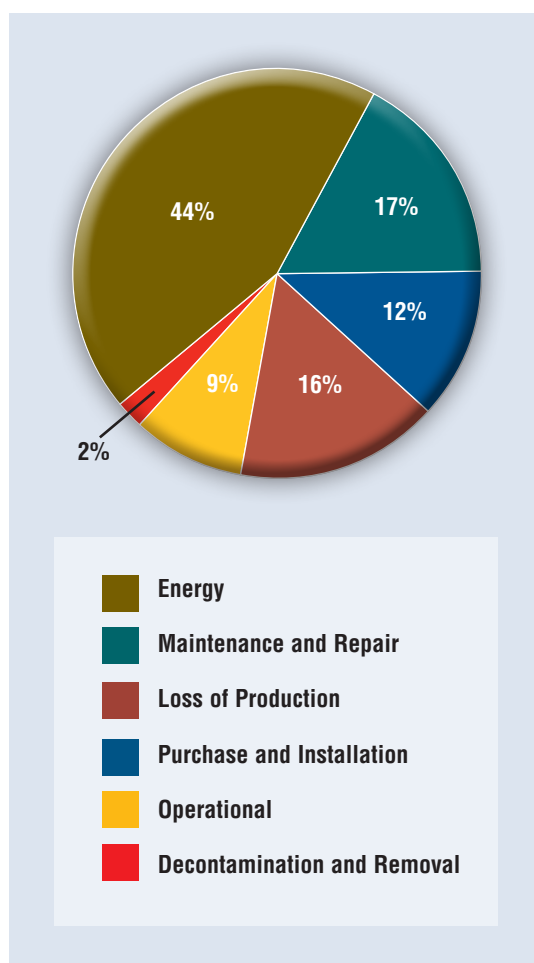

¹ While exact values may differ, these percentages are consistent with those published by leading pump manufacturers and end users, as well as industry associations and government agencies worldwide.



USA and Canada

Flowserve Corporation
5215 North O'Connor Blvd.
Suite 2300
Irving, Texas 75039-5421 USA
Telephone: +1 937 890 5839

Europe, Middle East, Africa

Flowserve Corporation
Parallelweg 13
4878 AH Etten-Leur
The Netherlands
Telephone: +31 76 502 8100

Latin America

Flowserve Corporation
Martín Rodríguez 4460
B1644CGN-Victoria-San Fernando
Buenos Aires, Argentina
Telephone: +54 11 4006 8700
Telefax: +54 11 4714 1610

Asia Pacific

Flowserve Pte. Ltd.
10 Tuas Loop
Singapore 637345
Telephone: +65 6771 0600
Telefax: +65 6862 2329

Bulletin PS-10-24e (E/A4) February 2015. © 2015 Flowserve Corporation

To find your local Flowserve representative:

For more information about Flowserve Corporation,
visit www.flowserve.com or call +1 937 890 5839.