



RVX Upgrade

ISO 13709/API 610 back pullout retrofit



Experience In Motion

The upgrade specialists

Flowserve developed the RVX back pullout assembly upgrade program to address users' needs for improved pump reliability with reduced maintenance costs. The RVX program assists users in reducing fugitive volatile organic compound (VOC) emissions while gaining the advantages of a bearing frame in full compliance with ISO 13709/API 610, latest edition. It also addresses users' needs for improving pump hydraulic efficiency or operating stability by replacing existing impellers with ones specifically selected for current operating modes. This dedicated aftermarket support program makes Flowserve unbeatable as a problem solver for improving field equipment reliability and reducing total lifecycle costs.

Proven reliability benefits

The RVX program applies to any existing ISO/API OH1 and OH2 pump installation, regardless of OEM.

- Increased reliability based upon a robust design with larger radial and thrust bearings and low L_3/D_4 ratio
- Full compliance with API 610 L_{10h} bearing life requirements
- Increased seal life attributed to large diameter shaft with low L_3/D_4 ratio for reduced shaft deflection with increased mean time between repair (MTBR) and reliability
- Elimination of cooling water by an outboard fan for heat convection
- No disturbance to existing suction and discharge piping
- High parts interchangeability based upon same parts used from Flowserve HPX pump product
 - Three standard frame sizes accommodate impeller diameters from 215 mm (8.5 in) to 525 mm (21 in)
 - Three standard seal chambers per API 682 dimensions to accommodate dual mechanical seals to control VOC emissions
- Lubrication system including constant level oiler with bearing isolators
- Oil slinger design to mitigate “dirty oil” appearance
- Quick Ship Program for significantly reduced turnaround time to upgrade existing pumps versus replacing with new equipment; upgrade in two to five weeks versus new pumps in 38 weeks

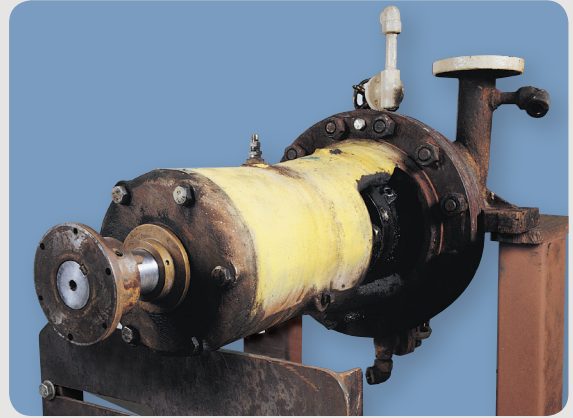

Before

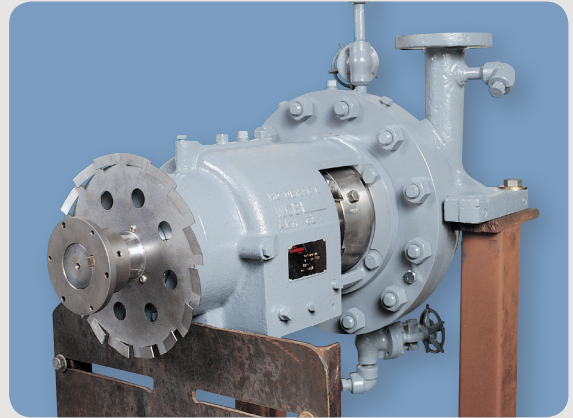

After

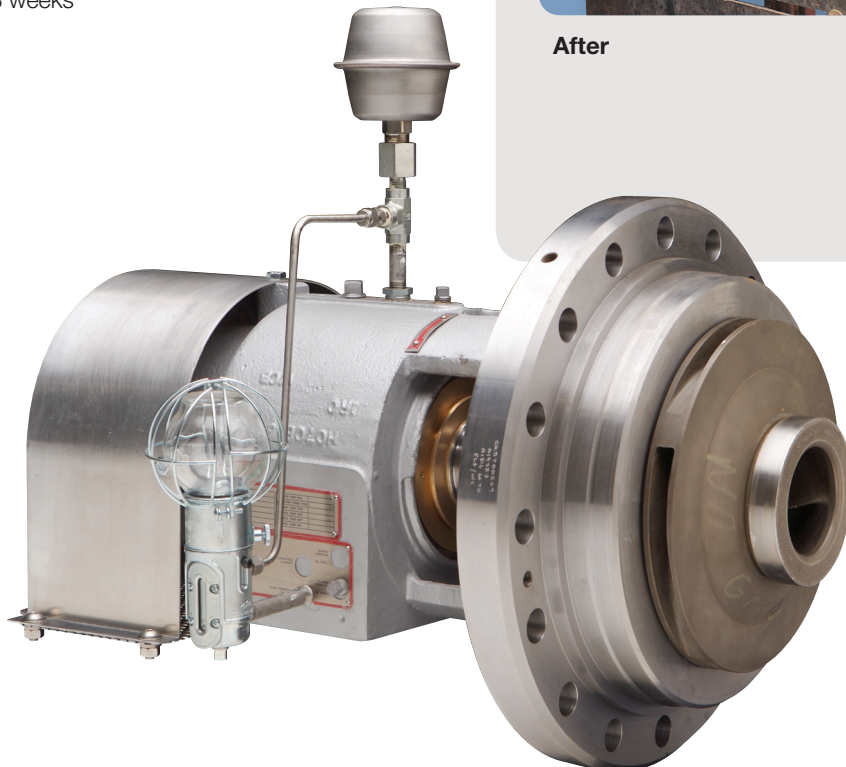

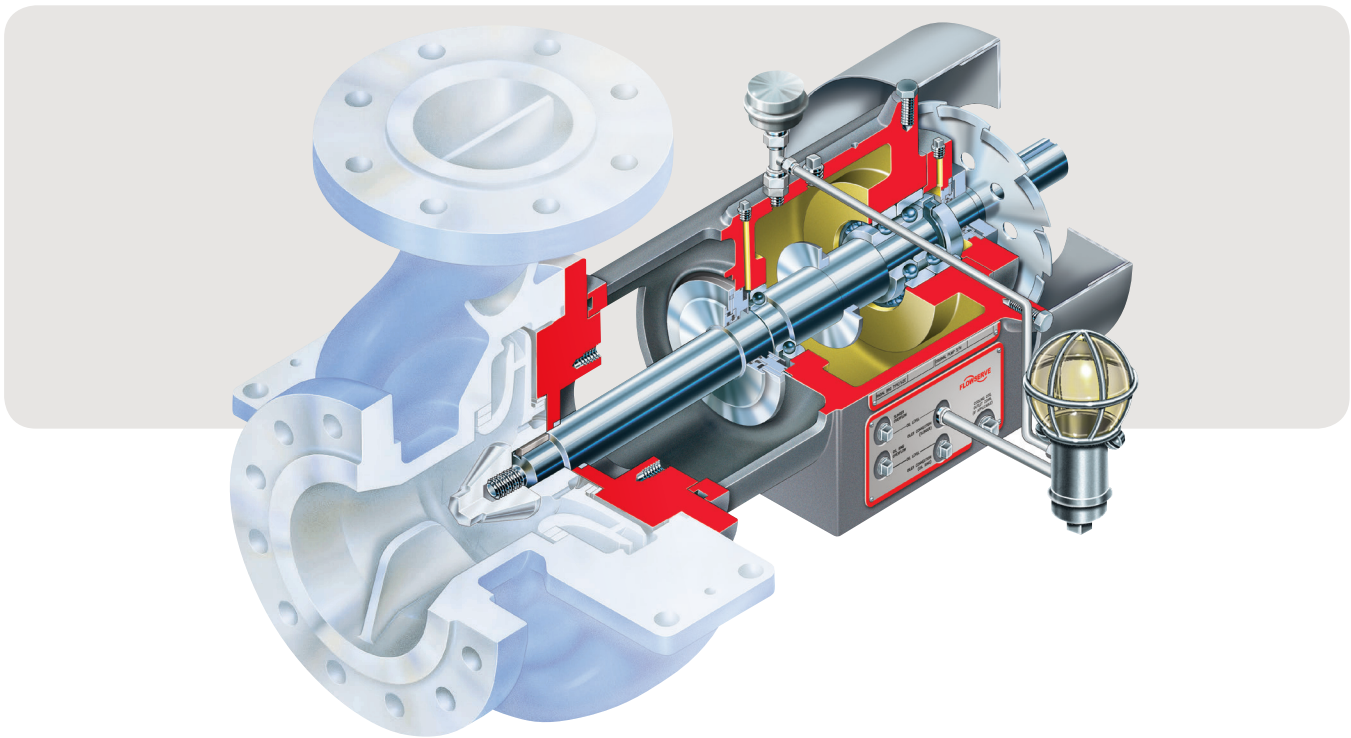

Improve MTBR and total cost of ownership

The RVX assembly enables users to extend the useful life of process pumps while simultaneously reducing their total cost of ownership. It accomplishes this by upgrading low technology or obsolete bearing assemblies and seal chambers to ISO 13709/API 610, latest edition-compliant components. Standard RVX assemblies include the following new components:

- Bearing housing and shaft assembly
- Head, fixed throat bushing and integral seal chamber
- Head wear ring
- Keys for impeller and coupling

The application of current technology combined with dedicated support by aftermarket specialists ensures improved MTBR of any ISO/API OH2 single-stage, two-stage or double-suction overhung pump.

New product warranty

Flowserve offers a new product warranty on all RVX assemblies.

Features and benefits

Heavy-duty construction to ISO 13709/API 610, latest edition, including carbon steel bearing housing, assures maximum reliability and safety.

Metal-to-metal casing/cover fit with fully confined, controlled compression gasket ensures proper sealing and alignment.

Outboard cooling fan use dependent on operational speed and service temperature.

Large radial and thrust bearings, combined with very low shaft stiffness ratios (L_3/D_4) and low shaft deflection, promote long life for bearings and mechanical seals.

Lubrication system with constant level oiler and Flowserve Bearing Gard™ bearing isolators ensures optimal bearing lubrication and prevents ingress of contaminants for increased MTBR. Oil slinger design mitigates “dirty oil” appearance. Oil mist optional.

Fixed throat bushing design accommodates metallic and non-metallic bushings, permitting greater control of seal chamber pressure to suit application needs.

ISO 21049/API 682 seal chamber accommodates all popular dual seal arrangements without special engineering.

Air gap machined in bearing housing bolting flange that insulates the housing from heat mitigation in hot services.

Standard outboard fan

Standard outboard fan eliminates the need for bearing cooling water and extends the operating temperature of the pump to 450°C (840°F) with no auxiliary support required.

Maximized parts interchangeability

The RVX enables users to maximize parts interchangeability. All ISO/API OH1 and OH2 single-stage, two-stage and double-suction overhung pump wet ends, regardless of OEM, may be retrofitted with the RVX. Bearing housing parts are interchangeable with HPX and HPXM components.

Dimensional consistency

With very few exceptions, the pump's discharge centerline to driver coupling face dimension remains unchanged on pumps retrofitted with the RVX. This is accomplished by selecting a longer coupling spacer, if necessary, to permit a drop-in-place assembly. Additionally, shafts are machined to fit the original pump dimensions.

Quick payback

Reliability payback

The reliability payback of the RVX in a recent 50-pump program was 1.84 years as calculated by the user. This was based on the significant reduction in cost and time to upgrade the pull-out assemblies versus completely replacing pumps. Improved reliability to ISO 13709/API 610, latest edition, is also assured.

Energy payback

Energy payback on the RVX can be realized by application of an optimized impeller. Consider the following facts from an actual case history:

- Reduction of 100 kWh
- Energy cost reduction of US\$35 415 annually using US\$0.04 per kWh and around-the-clock operation
- 0.62 years payback on energy savings

RVX assembly with expansion chamber, standard oiler, fan guard and optional coupling guard



Significantly reduced lead time

The RVX retrofit improves pump performance and reliability significantly faster than purchasing a new pump. Typical lead time for a new pump is 38 weeks; the typical lead time for an RVX is just six weeks — a savings of 32 weeks.

Lead time comparison



Hydraulic rerates, options and technical data

Hydraulic rerates for optimal performance

Customized volute to impeller relationship

The relationship between the casing volute and the impeller can be customized to improve hydraulic stability over the entire pump operating range.

New or rerated impeller

A new or rerated impeller can be provided as an option to meet changing operating conditions.

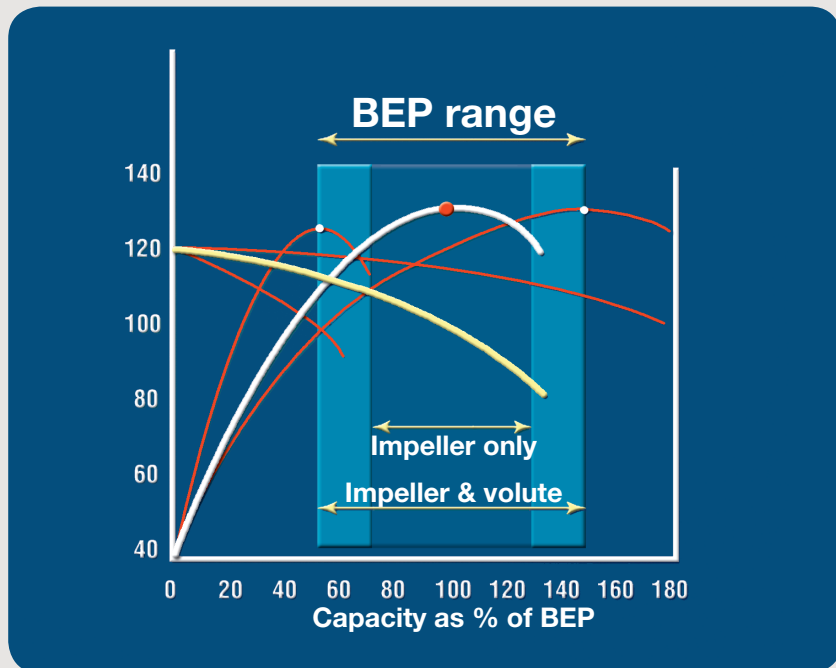
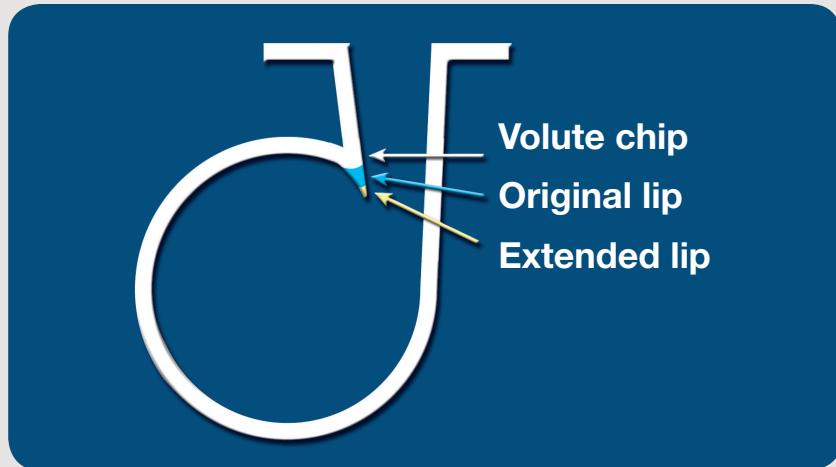

Electronic documentation

The RVX upgrades include the following electronic documentation:

- Cross-sectional drawing
- Outline drawing of pump
- Seal chamber drawing
- IOM manual addendum
- Parts list

The following electronic documents are provided when applicable:

- Coupling drawing
- Seal assembly drawing
- Seal flush schematic
- Required baseplate modification instructions

Optional hardware package

- Impeller
- Mechanical seal
- Seal flush piping
- Coupling and coupling guard

Material upgrades

Material upgrades can be incorporated into upgrade kits for improved operating life of these parts:

- Cover
- Shaft
- Gaskets
- Wearing rings (metallic or non-metallic)
- Throat bushing (metallic or non-metallic)

Service and repair options

- Casing repair
- Pump assembly
- Field inspection
- Field engineering
- Field machining

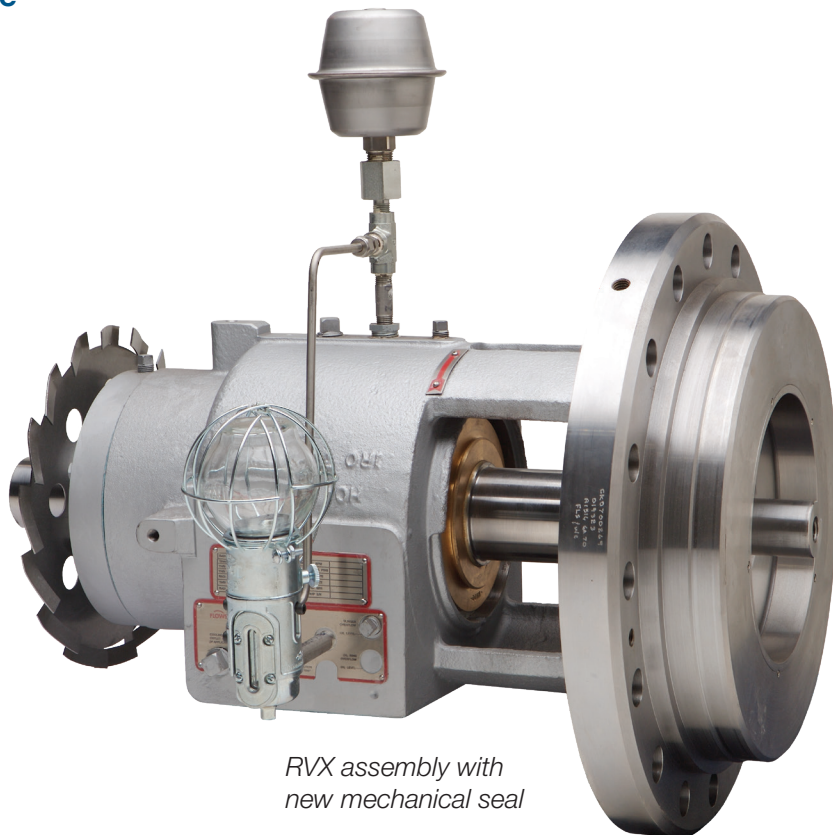

RVX assembly with new mechanical seal



Flowserve Corporation
5215 North O'Connor Blvd.
Suite 2300
Irving, Texas 75039-5421 USA
Telephone: +1 937 890 5839

PS-100-7i (E) April 2019

Flowserve Corporation has established industry leadership in the design and manufacture of its products. When properly selected, this Flowserve product is designed to perform its intended function safely during its useful life. However, the purchaser or user of Flowserve products should be aware that Flowserve products might be used in numerous applications under a wide variety of industrial service conditions. Although Flowserve can provide general guidelines, it cannot provide specific data and warnings for all possible applications. The purchaser/user must therefore assume the ultimate responsibility for the proper sizing and selection, installation, operation, and maintenance of Flowserve products. The purchaser/user should read and understand the Installation Instructions included with the product, and train its employees and contractors in the safe use of Flowserve products in connection with the specific application.

While the information and specifications contained in this literature are believed to be accurate, they are supplied for informative purposes only and should not be considered certified or as a guarantee of satisfactory results by reliance thereon. Nothing contained herein is to be construed as a warranty or guarantee, express or implied, regarding any matter with respect to this product. Because Flowserve is continually improving and upgrading its product design, the specifications, dimensions and information contained herein are subject to change without notice. Should any question arise concerning these provisions, the purchaser/user should contact Flowserve Corporation at any one of its worldwide operations or offices.

©2019 Flowserve Corporation. All rights reserved. This document contains registered and unregistered trademarks of Flowserve Corporation. Other company, product, or service names may be trademarks or service marks of their respective companies.