



TECHNICAL BULLETIN

Logix 500si Series Digital Positioner

FCD LGENTB0056-01 – 12/05



Experience In Motion

500si Series Digital Positioners

Figure 1: Logix 500si Series

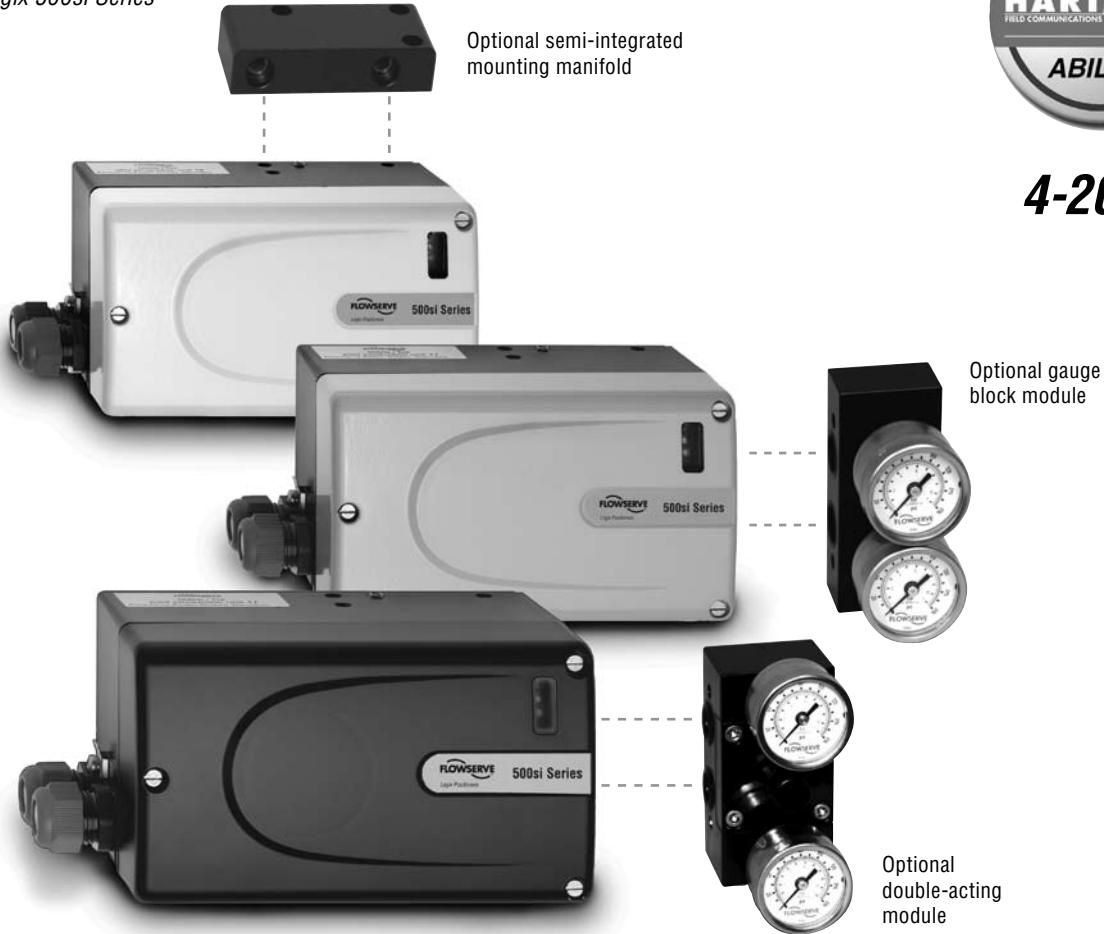

The Flowserve Logix 500si is the next generation of intrinsically safe digital positioners, which builds on the success of the Logix 500 design.

- The Logix 510si series serves the analog (4–20 mA) market, while offering all of the benefits of digital technology, such as simple, push-button calibration, diagnostics, etc.
- The Logix 520si is a “smart” positioner, which can communicate via the HART® communications protocol.

The Logix 500si series is built with the needs of the customer in mind, and offers several benefits and features, including:

Simple Calibration/Configuration – Status information, configuration, and diagnostic options are easy and convenient to access. The Logix 500si can be configured and calibrated without the use of any additional handheld device or configuration/calibration tool.

Semi-Integrated (SI) Mounting – The Logix 500si mounting design is simple, easy to install and maintain, and reduces the chance of injury.

Low Price – Logix 500si customers benefit from Flowserve’s global sourcing capabilities, and receive a robust digital positioner at an exceptional price.

Compact, lightweight, modular design – The Logix 510si and 520si use the same lightweight, compact housings and mounting hardware. All optional accessories, such as limit switches and side-mounted double-acting modules can be used on all models of the Logix 500si family. Modularity is our strength.

510si and 520si Digital Positioners

Features and Advantages

Features	Advantages	Logix 510si	Logix 520si
Easy Commissioning	Commissioning is performed by simply setting a few switches and pressing the QUICK-CAL button. The Direct User Interface provides local access to positioner control without requiring multi-level menus, a handheld communicator or laptop computer.	●	●
Local Status LEDs	LEDs, visible from a distance, indicate the positioner's current status without removing the cover.	●	●
Internal Diagnostic Codes	LEDs provide instant information relating to internal diagnostic codes. These codes indicate to the user positioner status and alarms without the need for a handheld communicator or laptop computer.	●	●
Fast and Simple Configuration	With its unique Direct User Interface, the Logix 500si positioner provides fast and easy configuration. Local configuration switches allow the user to set all basic parameters for positioner operation, such as output characteristic (e.g. equal percent, linear or custom), air action, signal direction, gain, tuning, etc. Calibration typically takes less than one minute.	●	●
Jog Calibrate	The jog calibrate function allows the user to easily and quickly calibrate the positioner on all actuators without physical stroke stops.	●	●
Auto Tune	Adapting the response of the Logix 500 series positioner to a particular valve configuration is as simple as pressing a button. The Logix 500 positioner has a built-in auto-tuning function that, when enabled, quickly adjusts the response to match the valve and actuator. If the automatic tuning does not match the needs of the process, it can be modified in seconds by selecting a less aggressive auto-tune (gain) setting from the local user interface. Once set, the tuning is fixed until the next time an auto-tune is performed.	●	●
HART Communication	Using industry standard HART protocol, the Logix 500si positioner can use existing handheld communicators and supply extensive information to maintenance database software packages.		●
Low Air Consumption	State-of-the-art piezo technology combined with inner-loop feedback produces high-performance control with minimal air consumption.	●	●
21-Point Characterization	With <i>SoftTools</i> software or a handheld communicator, a custom 21-point characterization curve can be generated that can be used to change the response of the positioner to meet the process requirements.		●
Diagnostics	<i>SoftTools</i> allows the user to gather detailed diagnostic information regarding valve performance and positioner condition, in addition to the LED status codes.		●
Two-Stage Control Design	Positioner uses two-stage control to provide faster response and tighter control.	●	●
Configuration Lockout	Configuration lockout option in <i>SoftTools</i> permits users to perform automatic calibration procedures without modifying existing configuration and tuning settings.		●
NAMUR and VDI/VDE	NAMUR and VDI/VDE mounting interfaces provide direct standardized mounting to various linear or rotary actuators. Brackets are available for non-NAMUR actuators.	●	●
Compact and Lightweight	The positioner's compact design allows it to be installed on smaller actuators.	●	●
Multiple Limit Switch Options	Modular design allows reliable, inexpensive, non-contact, high resolution limit switches.	●	●
Self-Adjusting Linkage	Connecting the position feedback linkage of the Logix 500 series positioner to an actuator is simplified by the ability of the feedback arm to rotate 360° and adapt to any shaft rotation angle between 15° and 100° at any orientation.	●	●

510si Series Digital Positioners

Introduction

Figure 2: Logix 510si Digital Positioner

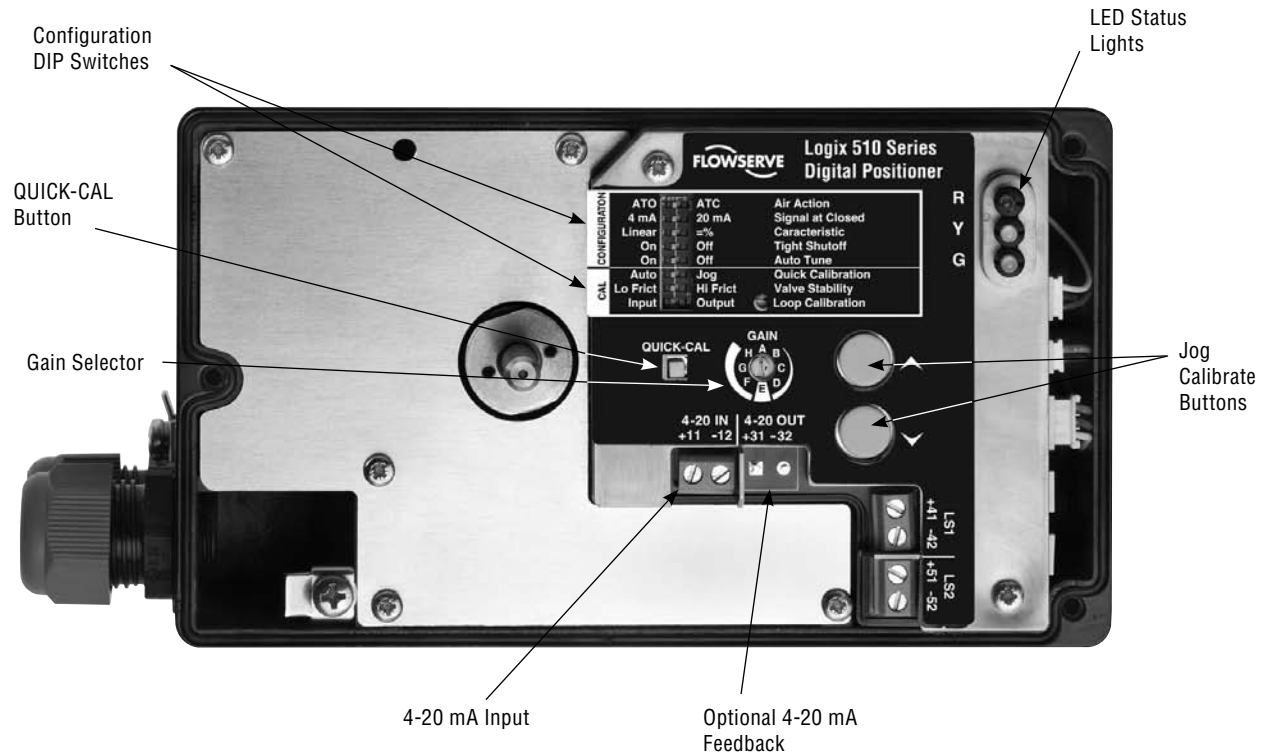

The Flowserve Logix 510si series are single-acting, user-friendly digital positioners. As with all positioners in the Logix 500si family, the Logix 510si uses the latest piezo-technology with inner-loop feedback to produce an improved dynamic behavior. The complete configuration can be made by DIP switches on the device. Different gain values allow the best setup for each individual actuator size.

Three colored LED indicators continuously indicate the positioner status. Fast calibration and setup can be achieved by simply pressing the QUICK-CAL button. Interchangeable components such as circuit board, piezo-drivers, etc., allow an easy and economical upgrade or repair. Optional 4–20 mA analog feedback circuit and proximity limit switches complete the Logix 510si.

510si Series Digital Positioners

Principle of Operation

Figure 3: Logix 510si Digital Positioner Schematic

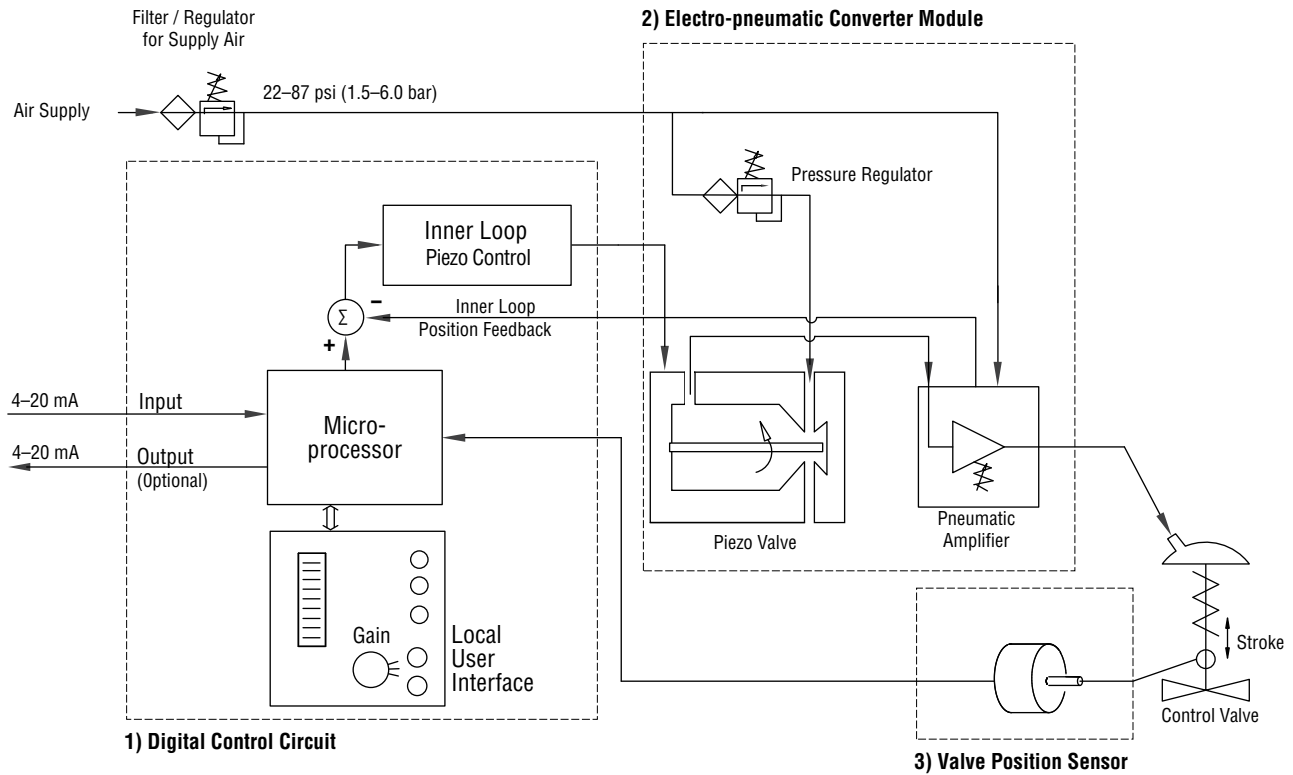

The Flowserve Logix 510si positioner is a digital positioner operated with an analog 4–20 mA input signal. The positioner consists of three main modules: 1) the microprocessor-based electronic control module with optional analog feedback and direct local user interface switches; 2) the piezo-valve-based electro-pneumatic converter module; and 3) the infinite resolution valve position sensor.

Figure 3 shows the principle of operation of the Logix 510si. The analog 4–20 mA command signal is passed to the microprocessor, where it is compared to the measured valve stem position. The control algorithm in the processor performs dual gain calculations and produces an output command to the analog piezo valve, which drives the pneumatic amplifier. The pilot valve position in the pneumatic amplifier is measured and relayed to the inner loop control

circuit. This two-stage control provides for a more responsive and tighter control than is possible with a single-stage control algorithm.

The pneumatic amplifier controls the airflow to the actuator. The change of pressure and volume of the air in the actuator causes the valve to stroke. As the valve approaches the desired position, the difference between the commanded position and the measured position becomes smaller and the output to the piezo is decreased. This, in turn, causes the pilot valve to close and the resulting airflow to decrease, which slows the actuator movement as it approaches the new command position. When the actuator has reached the desired position, the pneumatic amplifier output is held at zero, which holds the valve in a constant position.

510si Series Digital Positioners

Self Diagnostic Features

The Flowserve Logix 510si digital positioner automatically provides users with comprehensive, detailed diagnostic information. Colored LEDs continuously indicate positioner status or health during normal operation or calibration. This information can be used to determine whether a valve is functioning properly or needs service.

In total, 28 different status situations can be displayed, e.g.:

- Normal operation, no internal problems
- Device is undergoing calibration
- Calibration error detected
- Deviation error detected
- Internal electronic board error

Specifications

Table 1: Input Signal

Input Signal Range	4–20 mA
Compliance Voltage	6.0 VDC
Voltage Supply (maximum)	30 VDC
Minimum Required Operating Current	3.6 mA

Table 2: Stroke Output

Feedback Shaft Rotation	Minimum 15°, Maximum 90°, 40° recommended for linear applications
-------------------------	---

Table 3: Supply Air

Supply Air Quality	Free from moisture, oil and dust per IEC 770 and ISA-7.0.01
Input Pressure Range	22–87 psi (1.5 to 6.0 bar)
Air Consumption (steady state)	0.047 SCFM @ 22 psi 0.08 Nm ³ /h @ 1.5 bar 0.071 SCFM @ 87 psi 0.120 Nm ³ /h @ 6.0 bar

Table 4: Output Signal

Output Pressure Range	0–100% of supply air pressure
Output Flow Capacity (@ input pressure)	1.41 SCFM @ 22 psi 2.4 Nm ³ /h @ 1.5 bar 4.12 SCFM @ 87 psi 7.0 Nm ³ /h @ 6.0 bar

Table 5: Shipping Weights (includes mounting kit)

With Pressure Gauges	3.5 lb. (1.6 kg)
Without Pressure Gauges	2.7 lb. (1.2 kg)

Table 6: Performance Characteristics (typical)

Linearity	< ± 1.0%
Resolution	< 0.3%
Repeatability	< 0.5%
Deadband	< 0.5%

Table 7: Environmental Conditions

Operating Temperature	Standard	-4–176°F -20–80°C
	Low	-40–176°F -40–80°C
Transport and Storage Temperature	-40–176°F -40–80°C	
Operating Humidity	0–100% non-condensing	
Type	NEMA 4, NEMA 4X, IP65	

Table 8: Hazardous Area Specifications

ATEX	 II 1G EEx ia II C T6 Certificate No. Sira03ATEX2243
Non-incendive	FM Class 1, Division 2 Groups A, B, C, D Temp. Class. T4 Ta = 85°C
Intrinsic Safety	FM Class 1, Division 1 Groups A, B, C, D Temp. Class. T4 Ta = 85°C

Table 9: Physical Specifications

Housing Material	Cast aluminum, powder-painted
Soft Goods	Nitrile
Weight	2.7 lb. (1.2 kg)

520si Series Digital (HART) Positioners

Introduction

Figure 4: Logix 520si Digital Positioner

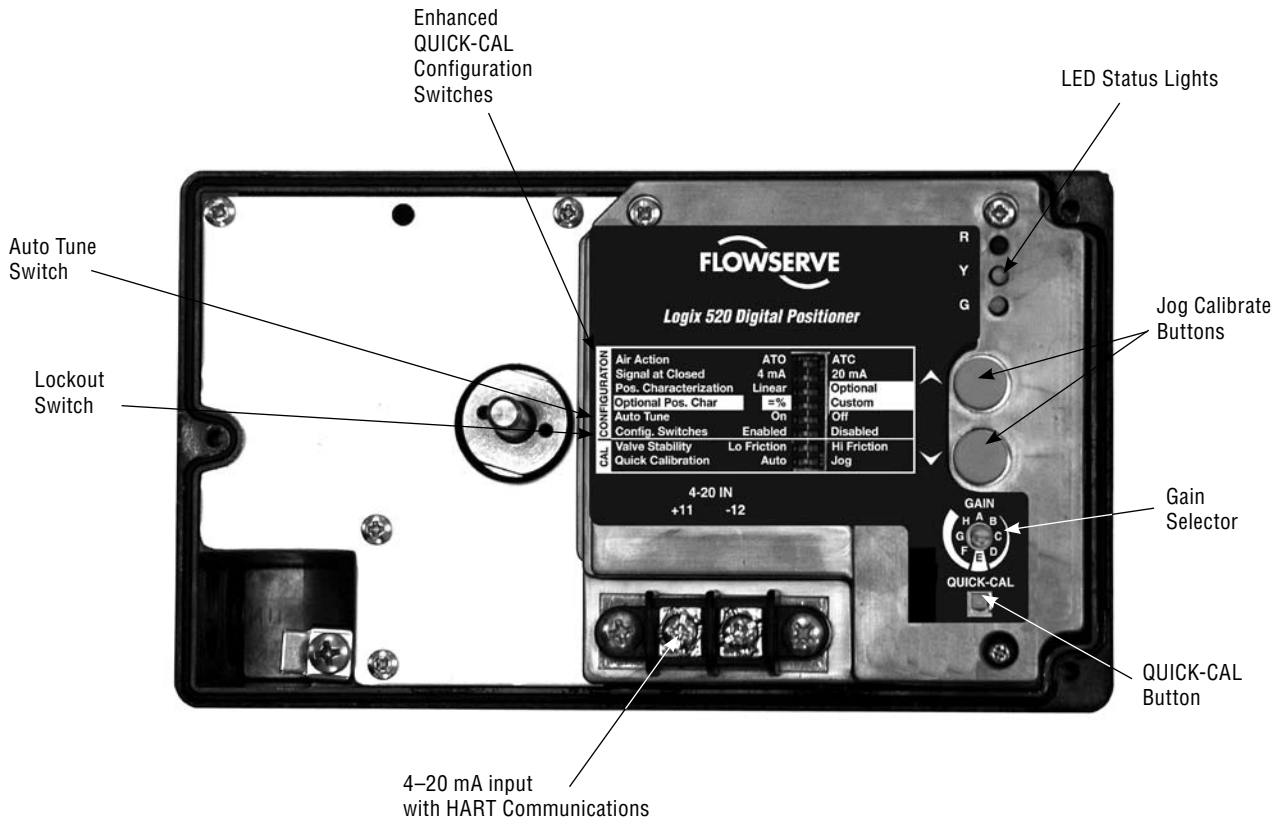

The Flowserve Logix 520si series digital positioners with HART communications capability are simple-to-use single-acting digital positioners. They combine state-of-the-art piezo valve technology with inner-loop feedback that provides high-performance control with minimal air consumption. The Logix 520si positioner is quickly and easily configured at the valve. The essential configuration settings do not require a hand-held device or a host system. Highly visible LED status lights allow the user to diagnose the condition of the valve at a glance. The Logix 520si positioner can be easily configured at the valve via the push-buttons and DIP switches, using a HART 275/375 handheld communicator, or with *SoftTools*™ software for diagnostics, alarms and communications.

Similar in cost to an analog I/P positioner, the Logix 520si series digital positioners provide quick setup and calibration, as well as high-performance digital communications. With its versatile mounting options, the Logix 520si digital positioner offers a cost-effective retrofit solution for applications requiring communication (HART protocol) and diagnostics for single-acting actuators from any manufacturer.

When used with Flowserve's *SoftTools* software, the Logix 520si positioner provides a wealth of information and functionality to the user, including 21-point characterization, dual-gain tuning, signatures for diagnostic purposes, and performance and accuracy measurements.

520si Series Digital Positioners

Principle of Operation

Figure 5: Logix 520si Digital Positioner Schematic

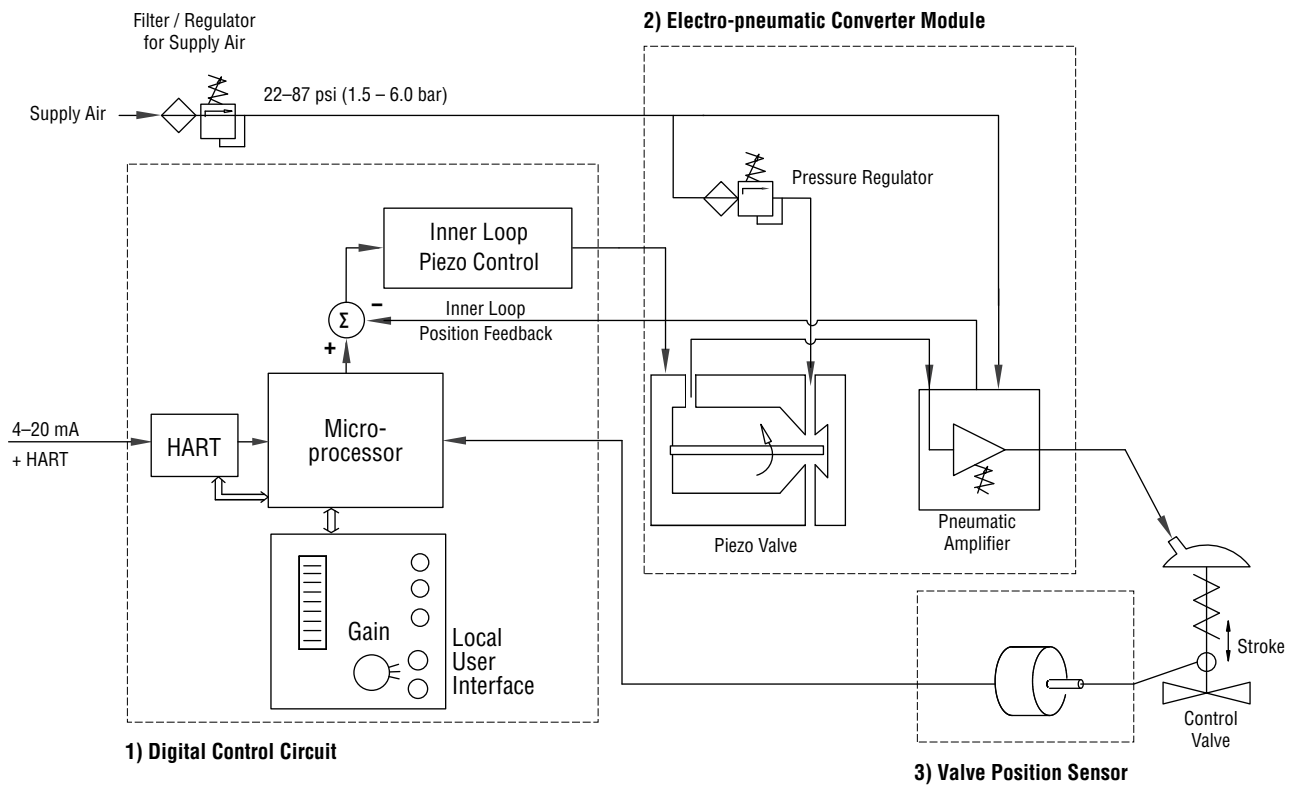

The Flowserve Logix 520si positioner is a digital positioner that incorporates the HART protocol for communication. The positioner consists of three main modules: 1) the microprocessor-based electronic control module includes HART communications and direct local user interface switches; 2) the piezo-valve-based electro-pneumatic converter module; and 3) the infinite resolution valve position sensor.

The basic positioner operation is best understood by referring to Figure 5. The complete control circuit is powered by the two-wire, 4–20 mA command signal. The HART module sends and receives the Frequency Shift Key (FSK) HART digital communications superimposed over the 4–20 mA signal wires, providing two-way digital communications to the microprocessor.

The analog 4–20 mA command is passed to the microprocessor, where it is compared to the measured valve stem position. The control algorithm in the processor performs dual gain control

calculations and produces an output command to the analog piezo valve, which drives the pneumatic amplifier. The pilot valve position in the pneumatic amplifier is measured and relayed to the inner loop control circuit. This two-stage control provides for more responsive and tighter control than is possible with a single-stage control algorithm.

The pneumatic amplifier controls the airflow to the actuator. The change of pressure and volume of the air in the actuator causes the valve to stroke. As the valve approaches the desired position, the difference between the commanded position and the measured position becomes smaller and the output to the piezo is decreased. This, in turn, causes the pilot valve to close and the resulting flow to decrease, which slows the actuator movement as it approaches the new command position. When the valve actuator is at the desired position, the pneumatic amplifier output is held at zero, which holds the valve in a constant position.

520si Series Digital Positioners

Self Diagnostic Features

The Flowserve Logix 520si digital positioner automatically provides users with comprehensive, detailed diagnostic information. Colored LEDs continuously indicate positioner status or health during normal operation or calibration. This information can be used to determine whether a valve is functioning properly or needs service.

Some of the conditions detected include:

- Normal operation, no internal problems
- Cycle limit is exceeded
- Travel limit is exceeded
- Device has exceeded upper or lower travel limits
- Device is undergoing calibration
- Calibration error detected
- Manual override in progress
- Board current too high
- Internal temperature limit exceeded

Specifications

Table 10: Input Signal

Input Signal Range (with HART)	4–20 mA
Compliance Voltage (with HART signal)	9.5 VDC
Voltage Supply (maximum)	30 VDC
Minimum Required Operating Current	3.6 mA

Table 11: Stroke Output

Feedback Shaft Rotation	Minimum 15° Maximum 90° 40° recommended for linear applications
-------------------------	--

Table 12: Supply Air

Supply Air Quality	Free from moisture, oil and dust per IEC 770 and ISA-7.0.01
Input Pressure Range	22–87 psi (1.5 to 6.0 bar)
Air Consumption (steady state)	0.047 SCFM @ 22 psi 0.08 Nm ³ /h @ 1.5 bar 0.071 SCFM @ 87 psi 0.120 Nm ³ /h @ 6.0 bar

Table 13: Output Signal

Output Pressure Range	0–100% of supply air pressure
Output Flow Capacity (@ input pressure)	1.41 SCFM @ 22 psi 2.4 Nm ³ /h @ 1.5 bar 4.12 SCFM @ 87 psi 7.0 Nm ³ /h @ 6.0 bar

Table 14: Shipping Weights (includes mounting kit)

With Pressure Gauges	3.5 lb. (1.6 kg)
Without Pressure Gauges	2.7 lb. (1.2 kg)

Table 15: Performance Characteristics (typical)

Linearity	< ±1.0%
Resolution	< 0.1%
Repeatability	< 0.2%
Deadband	< 0.2%

Table 16: Environmental Conditions

Operating Temperature	Standard	-40–176°F -40–80°C
Transport and Storage Temperature		-40–176°F -40–80°C
Operating Humidity		0–100% non-condensing
Type		NEMA 4, NEMA 4X, IP65

Table 17: Hazardous Area Specifications

ATEX	Ex II 1G EEx ia II C T6 Certificate No. Sira03ATEX2243
Non-incendive	FM Class 1, Division 2 Groups A, B, C, D Temp. Class. T4 Ta = 85°C
Intrinsic Safety	FM Class 1, Division 1 Groups A, B, C, D Temp. Class. T4 Ta = 85°C

Table 18: Physical Specifications

Housing Material	Cast aluminum, powder-painted
Soft Goods	Nitrile
Weight	2.7 lb. (1.2 kg)

520si Series Digital Positioners

SoftTools Interface

Introduction to SoftTools Software

Flowserve’s *SoftTools™ Suite* software helps manage field devices by combining features of field network hardware and a variety of communication protocols with the performance of Flowserve Logix 520si digital positioners. *SoftTools Suite* is a complete software package, featuring device status, configuration and calibration screens. Additionally, the user can access customized reports for all configuration, calibration and event data. *SoftTools* software opens the ‘window’ to the device and allows immediate views with live feedback on all active device sensors including valve stem position, control signal, and other important process metrics. Multiple instances of the software can be run simultaneously, addressing unique positioners. Up to 33 field devices can be viewed simultaneously, allowing the control professional to study cause and effect scenarios.

NOTE: SoftTools is available for download from www.flowserve.com.

SoftTools software enables communication between the software suite of tools and field device networks using the HART protocol and provides access to the diagnostic information from field devices. Using the MTL or ELCON brand HART multiplexer, users can access more than 63,000 Logix HART positioners from a single workstation. Additionally, the software includes an active database to capture configuration, calibration history and event logging for each digital positioner addressed through the software.

Users can now obtain a new level of detailed diagnostic information with *SoftTools* software. Diagnostic tests and functions (formally available only in strap-on diagnostic testers) are now part of the functionality. The software retains the traditional signature and logging features made popular in previous Flowserve software and adds scheduled polling for device alarms, critical diagnostic tests for friction, and performance analysis of positioners.

Configurator

Logix 520si configurations can be saved securely in a database file. By uploading a positioner configuration, the information is automatically saved and written to disk on the workstation. *SoftTools* software allows the user to selectively query the database to isolate or identify specific configurations. Therefore, the user can sort by any number of parameters including tag number, valve size or type, trim type, flow direction, and liquid or gas application. *SoftTools* software also allows the user to easily upload a configuration from the positioner. This means that a new replacement positioner can be identically configured with the simple click of a mouse once the correct configuration has been identified.

The configurator enables users to edit individual configurations, export to word processors and spreadsheets and import from other files. It also allows the user to format and print a positioner configuration report (Figure 6).

Figure 6: Configurator

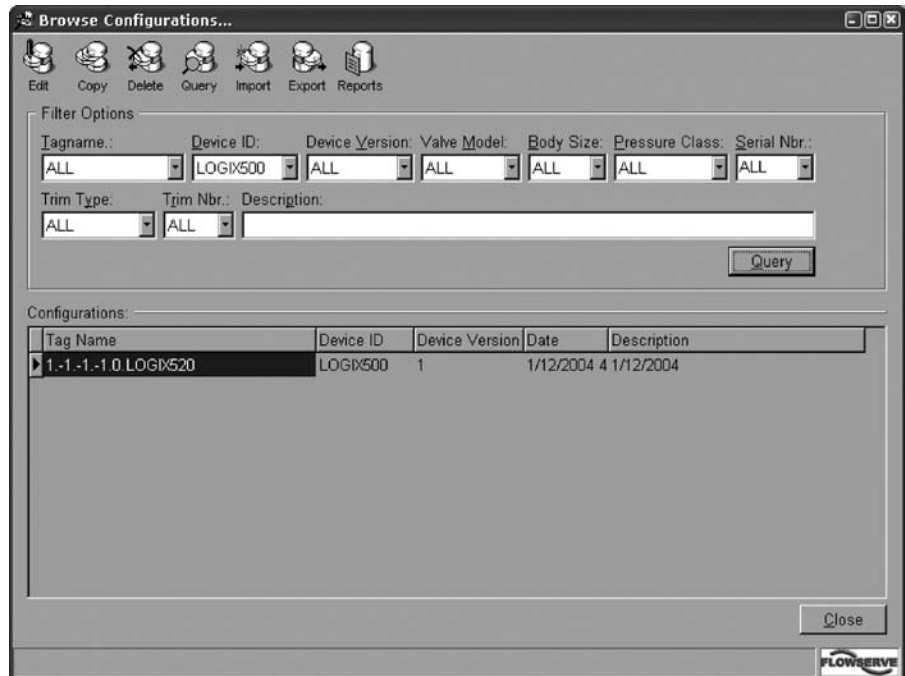

520si Series Digital Positioners

SoftTools Interface

21-point Characterization Curve

With *SoftTools* software, the user can adjust a 21-point characterization curve (Figure 7) to change the response of the positioner in order to meet the process requirements. The output of each control point is independent, allowing the user to create a custom curve with very high resolution. This customized curve can be saved in the memory of the Flowserve Logix 520si, and either activated or overridden with a simple on-board selector switch.

Tuning

Unlike other positioners that offer only one gain setting, the Logix 520si positioner provides dual-gain tuning. This allows the user to tune the positioner to make large step changes with minimal overshoot, while achieving the resolution to respond to very small step changes. The Logix 520si positioner not only provides several preset gain settings, it also allows the user to develop custom settings for a wide range of actuator sizes and types. Tuning sets can be configured, or selected with the HART 275/375 hand-held, *SoftTools*, or directly from the user interface on the positioner.

By setting the Auto Tune on/off DIP switch, the tuning mode can be changed from manual to auto. The Auto Tune procedure cycles the actuator (Figure 8) to produce a measured response and selects those gain values that provide appropriate actuator performance. The Auto Tune function includes a gain modifier selector that can be used to increase or decrease the calculated gain in order to achieve optimal performance.

Figure 7: 21-point Characterization Curve

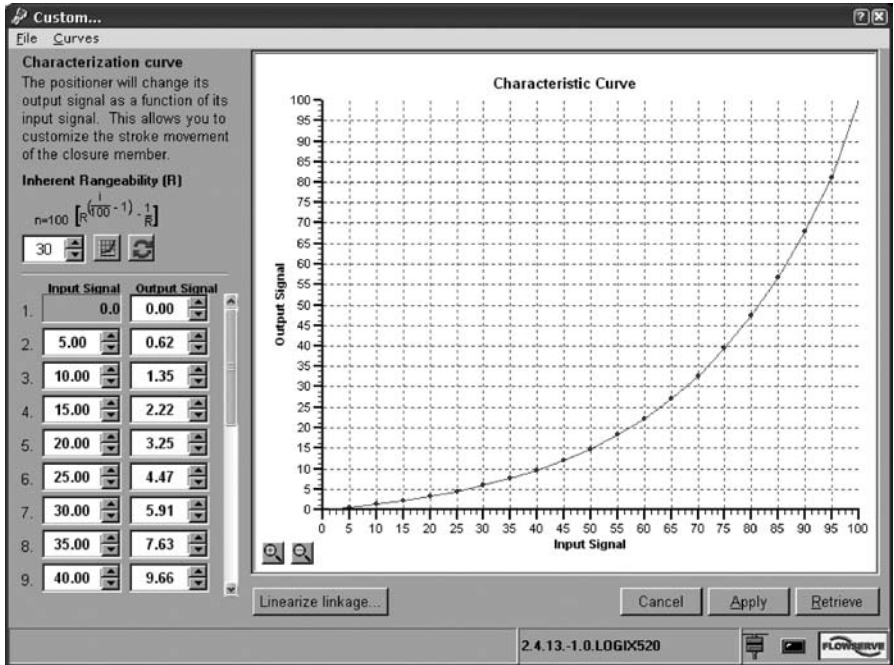
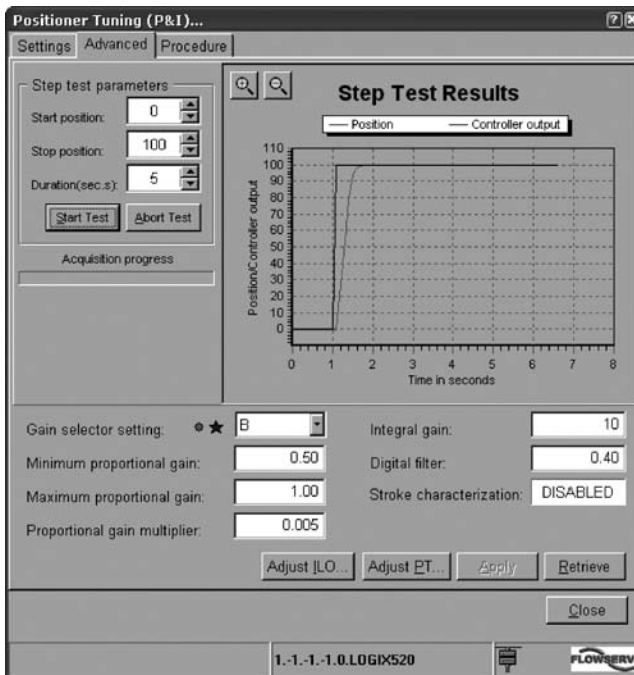

Figure 8: Manual Tuning with User Interface



520si Series Digital Positioners

SoftTools, Signatures and Performance Testing

Signatures

The Flowserve Logix 520si positioner is designed to assure that data is easily gathered, stored and compared to historical valve data so the user can determine the performance of critical valves.

With *SoftTools* software a user-defined signature ramp (Figure 9) or step response test can be generated with a Logix 520si positioner. Signatures can be saved and cataloged (and later retrieved) for comparison (Figure 10) with a more recent signature.

SoftTools software allows a user to easily overlay valve signatures and compare current performance with past performance over a particular time period. This allows the user to determine if degradation has occurred over time on critical valves. It also allows the user to compare historical data and determine if a valve needs to be pulled for maintenance. User-defined steps (large or small) can be tested and stored—large steps for speed and small steps for resolution and precision. Internal sensors allow the user to test the response and health of the valve at any time.

Positioner Performance

Static performance and accuracy measures such as hysteresis, deadband, linearity, and repeatability can be obtained with the Logix 520si positioner. These values can be graphically depicted, stored and later retrieved for comparative analysis (Figure 11).

Figure 9: Ramp Open Test

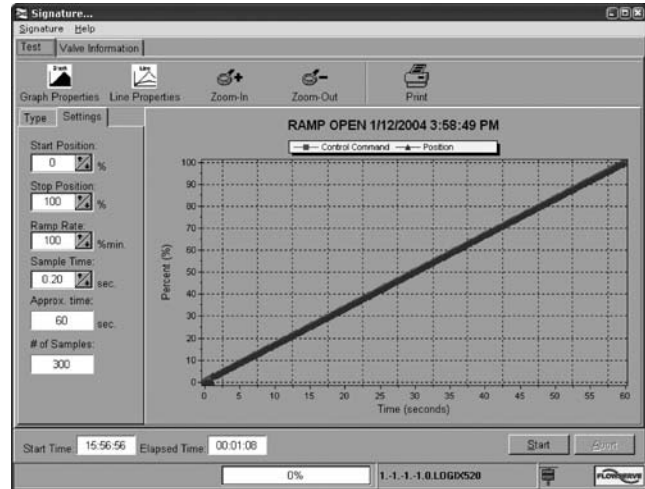

Figure 10: Signature Comparison

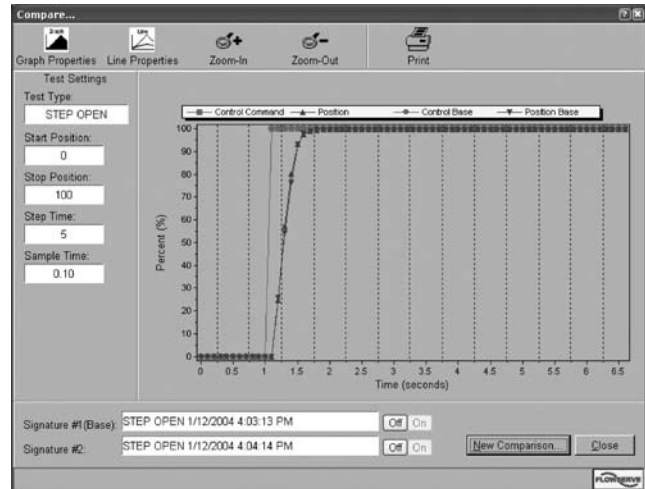
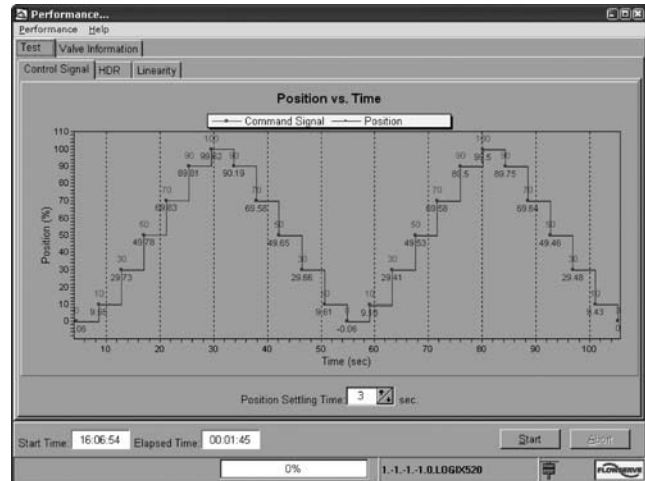

Figure 11: Performance Test



500si Series Digital Positioners

Limit Switches and Position Transmitter

Limit Switches (Optional)

The modular design of the Flowserve Logix 500si allows the use of two optional internal limit switches. This innovative, robust package provides the following features:

- Innovative, reliable technology
- Several limit switch options available:
 - Mechanical SPDT switches
 - Proximity (reed)
 - Namur slotted sensors
- Wide range of adjustment
- Intrinsically safe switches available
- High resistance to shock and vibration
- Limit sensing using two-wire sensor in accordance with NAMUR standards
- Infinite resolution of trip point

This option is available for the Logix 510si and the Logix 520si series.

Position Transmitter

The analog position transmitter (optional) provides an infinite-resolution 4–20 mA feedback signal proportional to the valve position throughout the complete stroke length.

- Automatically calibrated for 0% to 100%.
- Easy to calibrate for other configurations.

This option is currently only available for the Logix 510si series.

Analog Output Board (4–20 mA Transmitter) Option

Supply	9–20 VDC
Output	4–20 mA
Resolution	0.1%
Linearity full span	±0.5%
Output current limit	30 mA DC
Load impedance	800 Ω @ 24 VDC

Figure 12: Optional Internal Limit Switches

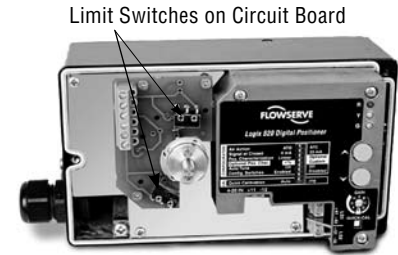

Figure 13: Position Transmitter Connection



Logix 500si Limit Switch Options

Model Option	Switch Type	Contacts	Ratings	Temperature Rating	Special Notes
1	Mechanical Limit Switch	SPDT	3 A/125 VAC, 2 A/30 VDC	-13°F to 185°F (-25°C to 85°C)	
2	Reed Switch	SPST	Current: 0.5 A Switching/1.2 A Carrying Voltage: 200 VDC maximum Switching/250 VDC minimum Breakdown	-40°F to 221°F (-40°C to 105°C)	
3	NAMUR V3 Type Proximity Switch, P+F NJ2-V3-N	Solid State	Load Current Target Present: ≤1 mA Load Current Target Absent: ≥3 mA (15 mA max.) Supply Voltage: 5–25 VDC	-14°F to 212°F (-26°C to 100°C)	
4	Slot-type NAMUR sensor, P+F SJ2 S1N	Solid State	Load Current Target Present: ≤1 mA Load Current Target Absent: ≥3 mA Supply Voltage: 5–25 VDC	-13°F to 212°F (-25°C to 100°C)	Normally Open. For use in “Control Safe” I.S. installations.
5	Slot-type NAMUR sensor, P+F SJ2 SN	Solid State	Load Current Target Present: ≤1 mA Load Current Target Absent: ≥3 mA Supply Voltage: 5–25 VDC	-40°F to 212°F (-40°C to 100°C)	Normally Closed. For use in “Control Safe” I.S. installations.
6	Slot-type NAMUR sensor, P+F SJ2N	Solid State	Load Current Target Present: ≤1 mA Load Current Target Absent: ≥3 mA Supply Voltage: 5–25 VDC	-13°F to 212°F (-25°C to 100°C)	Standard Switch. For use in standard I.S. installations.

Certifications: Limit switches are intrinsically safe when installed per appropriate Logix 500si IOM instructions and device entity parameters.

U.S. Switch Option Certifications are pending.

500si Series Digital Positioners

Mounting Options

The Flowserve Logix 500si series digital positioners feature a versatile mounting system. Mounting kits are available for NAMUR standard on linear actuators and VDI/VDE 3845 for rotary actuators (Figure 14).

Logix 500si positioners are also available with a semi-integrated mounting system in accordance with the new VDI/VDE 3847 standard (Figure 18). This eliminates exposed linkages while allowing easy access to mounting screws from the exterior for fast and easy service.

The unique mounting of the positioner to the FlowTop actuators (Figure 18) means that the positioner can be fitted to the actuator yoke for fail-closed operation with no exposed linkages, and without the need for external piping.

The Logix 500si digital positioner also lends itself for mounting to any type of diaphragm actuator. Brackets are available for the most popular brands and sizes of actuator.



Figure 14: Logix 500si Series Positioner mounted on Valtek MaxFlo 3 Eccentric Rotary Plug Control Valve.



Figure 15: Logix 500si Series Positioner mounting on a Kammer Control Valve Acc. to VDI/VDE 3847.



Figure 16: Logix 500si Series Positioner with Double-Acting Module mounted on a Mark One Valve Assembly.

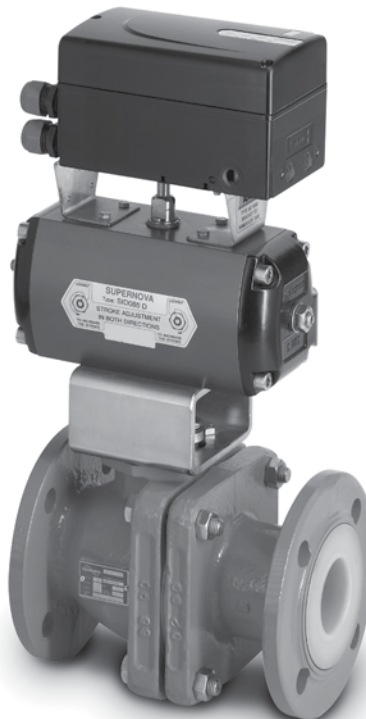

Figure 17: Logix 500si Series Positioner Acc. Industry-standard VDI/VDE 3845 (DIN ISO 5211) Mounting.



Figure 18: Logix 500si Series Positioner Mounted Directly on a FlowTop Valve Assembly.

500si Series Digital Positioners

Ordering Information

Option	Choice(s)	Description	Example
			5
Communication	1	No remote communications	2
	2	HART	
Electronic hardware options	0	Standard diagnostics	0
			si
Certifications	02	Intrinsically safe Class I, Div 1, Groups A, B, C, D (Factory Mutual/CSA)	14
	08	Nonincendive, Class I, Div 2, Groups A, B, C, D	
	14	General purpose	
	15	EEx ia IIC, ATEX II 1 G	
Housing and brand label	W	Flowserve: Aluminum, black with white cover	W
	Y	Flowserve: Aluminum, black with yellow cover	
	B	Flowserve: Aluminum, black	
	A	Accord: Aluminum, black	
Threaded connections	1	½ NPT conduit, ¼ NPT pneumatic	1
	2	M20 conduit, ¼ NPT pneumatic	
	3	½ NPT conduit, ¼ NPT pneumatic, ¼ NPT aux vent	
	4	M20 conduit, ¼ NPT pneumatic, ¼ NPT aux vent	
Feedback shaft	D	Standard Linear - D shaft	D
	R	Standard VDI/VDE 3845 Rotary shaft (NAMUR)	
Operating temperature	S	Standard -4°F to 185°F (-20°C to 85°C), Standard on 510	S
	E	Extended -40°F to 185°F (-40°C to 85°C), Standard on 520, optional on 510	
Language	E	English	E
	F	French	
	G	German	
Rotary indicator	0	No indicator	0
	F	Flat	
	D	Domed	
Special options	0	None	0
Add-in Electronic Circuits	0	No add-in circuits	0
	F	4–20 mA positon feedback (510 base model now)	
Limit switches	0	No switches	1
	1	Mechanical limit switch	
	2	Reed switch	
	3	Namur V3 type proximity switch, P+F NJ2-V3-N	
	4	Slot type NAMUR sensor, P+F SJ2 S1N	
	5	Slot type NAMUR sensor, P+F SJ2 SN	
	6	Slot type NAMUR sensor, P+F SJ2N	
Auxiliary Options (To be ordered seperately)			
Manifold options	DA	Double acting	DA
	GM	Gauge manifold	
	VE	VDI/VDE 3847 semi-integrated manifold	
Gauge options	0	No gauges	1
	1	Output, psi (bar, kPa) Stainless with brass internals	
	2	Output + Supply, psi (bar, kPa) Stainless with brass internals	
	3	Output, psi (bar, kPa) Stainless with stainless internals	
	4	Output + Supply, psi (bar, kPa) Stainless with stainless internals	
	5	Output, psi (kg/cm ²) Stainless with brass internals	
	6	Output + Supply, psi (kg/cm ²) Stainless with brass internals	
	7	Output, psi (kg/cm ²) Stainless with stainless internals	
8	Output + Supply, psi (kg/cm ²) Stainless with stainless internals		



500si Series Digital Positioners

Dimensional Drawings

Figure 18: Logix 500si Digital Positioner Dimensional Drawings

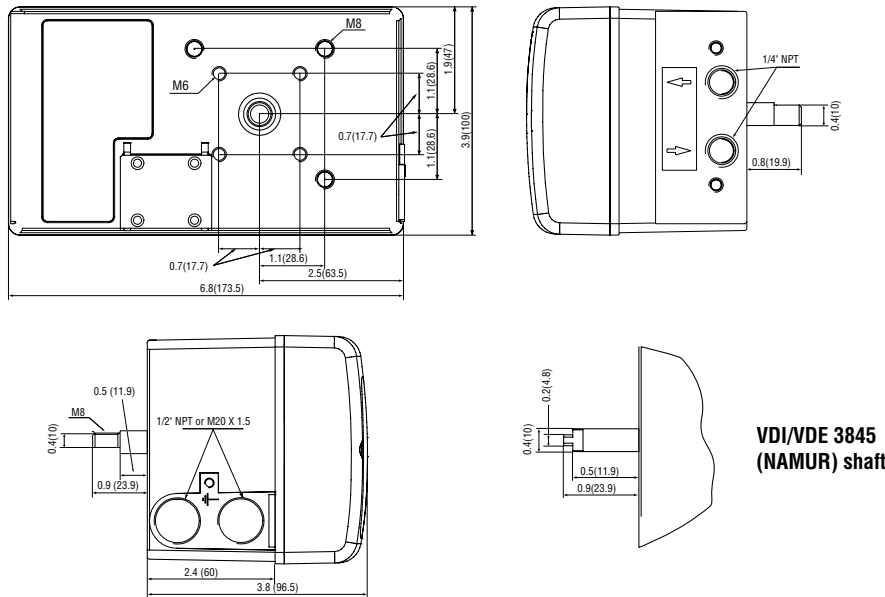

FCD LGENTB0056-01 Printed in USA.

To find your local Flowserve representative:

For more information about Flowserve Corporation, visit www.flowserve.com or call USA 1 800 225 6989

United States

Flowserve Corporation
 Flow Control
 1350 N. Mountain Springs Pkwy.
 Springville, UT 84663 USA
 Phone: 801 489 8611
 Facsimile: 801 489 3719
www.flowserve.com

Australia

Flowserve Australia, Pty. Ltd.
 14 Dalmore Drive
 Scoresby, Victoria 3179
 Australia
 Phone: 613-9729-2633
 Facsimile: 613-9729-2644

Singapore

Flowserve Singapore
 12 Tuas Avenue 20
 Singapore 638824
 Telephone: +65 862 3332
 Facsimile: +65 862 4940

Flowserve Corporation has established industry leadership in the design and manufacture of its products. When properly selected, this Flowserve product is designed to perform its intended function safely during its useful life. However, the purchaser or user of Flowserve products should be aware that Flowserve products might be used in numerous applications under a wide variety of industrial service conditions. Although Flowserve can (and often does) provide general guidelines, it cannot provide specific data and warnings for all possible applications. The purchaser/user must therefore assume the ultimate responsibility for the proper sizing and selection, installation, operation, and maintenance of Flowserve products. The purchaser/user should read and understand the Installation Operation Maintenance (IOM) instructions included with the product, and train its employees and contractors in the safe use of Flowserve products in connection with the specific application.

While the information and specifications contained in this literature are believed to be accurate, they are supplied for informative purposes only and should not be considered certified or as a guarantee of satisfactory results by reliance thereon. Nothing contained herein is to be construed as a warranty or guarantee, express or implied, regarding any matter with respect to this product. Because Flowserve is continually improving and upgrading its product design, the specifications, dimensions and information contained herein are subject to change without notice. Should any question arise concerning these provisions, the purchaser/user should contact Flowserve Corporation at any one of its worldwide operations or offices.

© 2005 Flowserve Corporation, Irving, Texas, USA. Flowserve is a registered trademark of Flowserve Corporation.