



Equipment and Services for Reverse Osmosis Desalination Systems



Experience In Motion



Reduce your total cost with a complete RO solutions provider

As global demand for clean water continues to accelerate, safe and reliable desalination solutions are increasingly important to many communities. The energy-efficient and scalable design of the seawater reverse osmosis (SWRO) process makes it the leading choice for municipal and commercial water supply.

With more than a half-century of experience providing key products incorporating the latest technologies and support services, Flowserve offers you industry-leading pumps and valves, high-efficiency ERDs, unmatched materials expertise and desalination-specific application knowledge. We are a single-source provider of complete, integrated flow-control systems for desalination plants around the world.

Desalination Center of Excellence

The Flowserve Desalination Center of Excellence in Spain specializes in manufacturing and testing the industry's broadest desalination product portfolio and is backed by a global support network — a one-stop shop for customer support. With more than 50 years of experience in desalination, Flowserve brings deep knowledge, extensive capabilities, and locally available R&D resources to meet our customers' needs.



Watch the video!

Fully integrated systems and services

Unlike most manufacturers, Flowserve has the ability to provide you with complete, fully integrated flow-control solutions. In addition, you'll enjoy a wide range of benefits that will keep your total cost of ownership low, including:

- A single-source supplier that is accountable for all major equipment, including pumps, energy recovery devices (ERDs), valves and mechanical seals
- Unparalleled design and operation expertise that maximizes your efficiency
- A robust worldwide service network, with local support of parts, repairs and service through nearly 200 global Quick Response Centers
- Equipment and system optimization
- An end-to-end internet of things (IoT) suite of solutions that can help operators increase process and operational efficiency, anticipate equipment failures and avoid process disruptions
- Performance and availability guaranteed by condition monitoring and fixed-fee maintenance contracts
- Customized aftermarket solutions, including service, maintenance and upgrades
- Educational services that train your personnel in the selection, operation and maintenance of pumps, energy recovery devices, seals and valves

Experience that counts

Flowserve understands the challenges you face, from energy consumption and high-pressure pumps to the other obstacles faced by every business model in the industry. That's why Flowserve equipment is installed in some of the biggest desalination plants in the world and more than two-thirds of mega SWRO projects use Flowserve pumps and ERDs. We've been a leader in desalination since it was commercialized on a large scale, and have partnered with some of the world's largest desalination engineering, procurement and commissioning (EPC) contractors, developers and end users to build plants using thermal and membrane technologies.

Whether your site is a government-backed fixed EPC project or a privately financed and operated venture, dedicated Flowserve desalination experts and project managers are available to help you optimize your operation.

Make the most of your energy investment

While advances in membrane and energy recovery technologies are making SWRO and brackish water reverse osmosis (BWRO) more economical, energy consumption remains the biggest operating cost of reverse osmosis (RO) desalination.

Optimize efficiency

Since high-pressure pumps and other equipment in RO plants can consume a lot of power, we design optimal efficiency into every one of our systems. Our high-pressure membrane feed pumps and ERDs feature optimized hydraulics and advanced materials to keep your operating costs low and your plant running profitably. You'll also have access to detailed systems knowledge, along with a full menu of technical support services, wherever and whenever you need them, to ensure your plant's availability goals are met.

Streamline execution

For new projects or major upgrades, dedicated global project managers and engineering experts will help you streamline execution. You'll get a total-solution approach, focused on creating the most efficient and technologically advanced systems. Flowserve works with your teams to select equipment, maximize overall efficiency, and optimize plant layout. We'll also work tirelessly to ensure installation and commissioning meet your requirements and schedules.

Manage risks

For existing operations, Flowserve offers aftermarket services and supporting infrastructure to help you manage risks. Turnkey maintenance contracts guarantee best efficiencies of key equipment, while monitoring and preventative maintenance service plans make sure your plant availability and throughput goals are achieved.

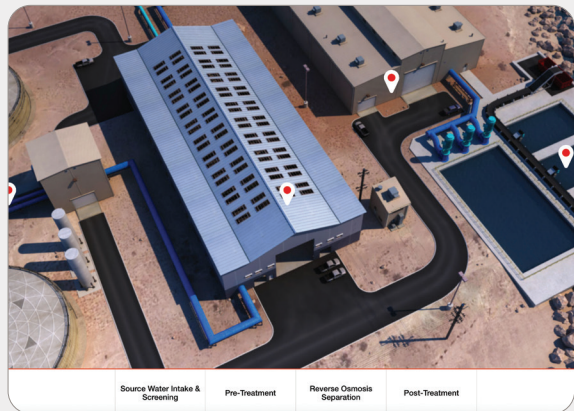

Explore the Flowserve VirtualPlant

Flowserve VirtualPlant tool offers an innovative way for you to explore Flowserve products and capabilities for the desalination industry. A 3D model of a reverse osmosis plant makes it easy to see which products are used in key processes. The information within VirtualPlant is based on actual use cases, so you can be confident that all product recommendations are based on proven customer scenarios and real-world conditions.



Check it out now!

SWRO products and capabilities

The simple design, lower energy consumption and smaller footprint of the reverse osmosis process have made this technology the choice for most municipal, industrial and commercial desalination projects. Flowserve enhances these advantages for your business by delivering capabilities that address major pump, energy recovery, seal and valve requirements.

Energy recovery devices

Energy is generally the biggest cost driver in any SWRO desalination facility, making energy recovery critical to your success. Flowserve is a world leader in the manufacture and supply on the most efficient energy recovery devices for the SWRO desalination process.

Flowserve offers the following leading technologies for energy recovery:

- **Flowserve FLEX™ pressure exchanger** — a next-generation compact isobaric recovery device that recovers more than 98% of the hydraulic energy and the highest capacity per unit on the market
- **Dual Work Exchanger Energy Recovery (DWEER)** — an isobaric energy recovery device capable of recovering up to 98% of the energy in the brine waste stream
- **Energy recovery turbines** — capable of recovering as much as 90% of the hydraulic energy in the brine waste stream

In addition to minimizing your current power usage, all of these technologies help minimize the impact of future energy cost increases.

Pumps

Desalination applications for pumps run the gamut, from source water intake and pressure boosting to various feed and chemical applications. Key configurations and pumping solutions supported by Flowserve include:

- Vertical wet- and dry-pit configurations (VCT, VTP, LNNV, SUBM)
- Between bearings, single-stage (DVSH-RO, LNN, LRN)
- Vertical inline process pumps (LNNV)
- Horizontal, overhung process pumps (DS-RO, HHPX, Z Series)
- Between bearings, multistage (DMX-RO, CSX, MS)

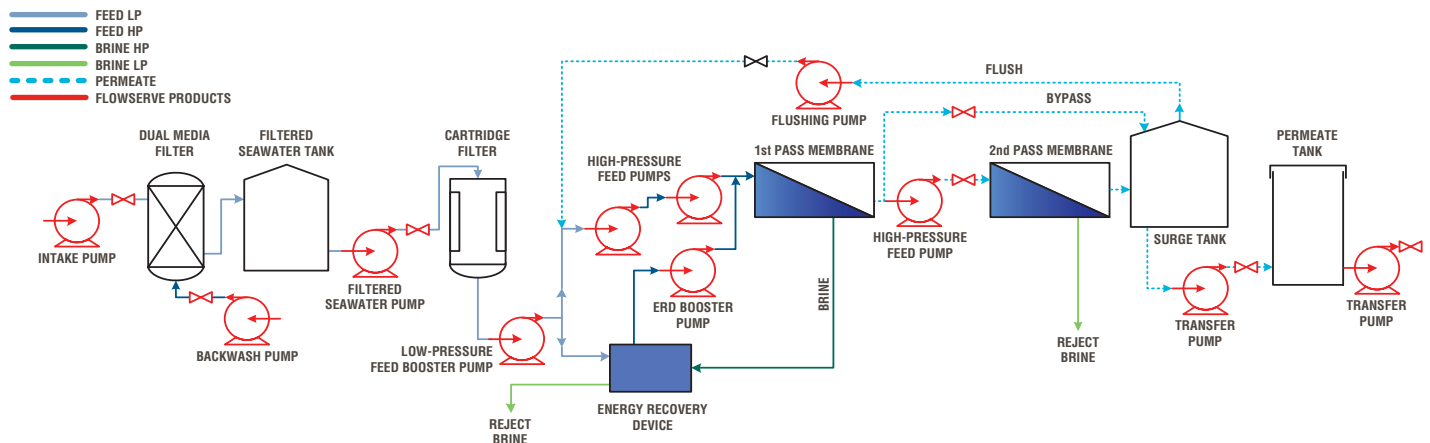

Mechanical seals for SWRO

Mechanical seals are integral to the range of pumps used in SWRO desalination plants, providing maximum reliability with minimal downtime. Unmatched expertise in metallurgy, combined with the application of sophisticated mechanical seal technology in the toughest applications, allow Flowserve to help you extend the mean time between failure (MTBF) of your critical equipment.

Valves and actuators for SWRO

Desalination processes, particularly SWRO systems, require numerous valves capable of handling large volumes of water at high pressures. These valves must also be made of materials capable of resisting corrosion from chloride-rich water and commonly used chemicals. Flowserve offers a complete range of valves and actuators to suit diverse desalination applications.

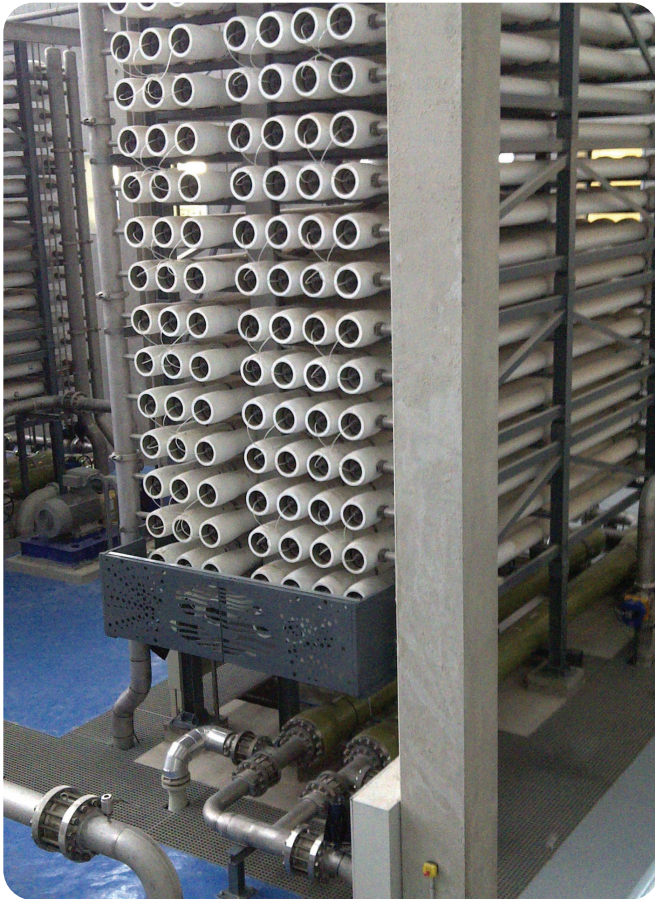

SWRO membrane train with DWEER energy recovery device installed in Spain

Corrosion-resistant materials ensure long-lasting performance

All Flowserve equipment that comes into contact with seawater or brine is delivered in super duplex stainless steel, titanium or non-metallic materials, capable of withstanding seawater or even brine with increased total dissolved solids (TDS).

For high-pressure and ERD booster pumps, Flowserve can supply equipment in Flowserve Alloy, a special austenitic stainless steel. With decades of proven stability in desalination applications, Flowserve Alloy is ideal for applications where high temperatures and salinity make for very aggressive fluids.

Upgrade options for existing installations

ERDs, pumps, membranes and other important features have seen continuous improvement over the last few decades with the development of new technologies. By integrating these innovations into your existing facility, Flowserve can deliver efficiency and reliability improvements that enhance your business in four key ways:

- Increased plant efficiency
- Increased plant production
- Reduced plant maintenance
- Increased availability

These benefits can be achieved by overhauling existing equipment with additional reliability features, upgraded hydraulics or other capabilities. In addition, existing ERDs can be replaced with newer technologies that improve both your efficiency and product capacity.

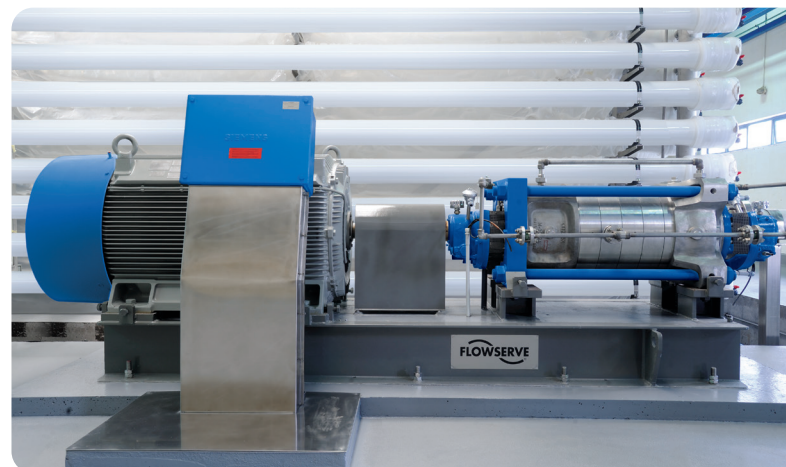

Energy recovery devices for SWRO

Flowserve FLEX™ pressure exchanger

Energy is the primary cost driver in any reverse osmosis (RO) desalination process. That's why Flowserve designed the Flowserve FLEX pressure exchanger, an isobaric energy recovery device, to be the most efficient and compact device of its type. Capable of recovering more than 98% of hydraulic energy and boasting the highest unit capacity available in the market, it drives down the cost of desalination by substantially reducing operating costs as well as capital expenditures.

The Flowserve FLEX energy recovery device is not only highly efficient, but with only four major components, it's also incredibly simple. Precision machined from highly corrosion- and wear-resistant materials, it ensures a long lifecycle with no maintenance or downtime. And, with the smallest footprint of any isobaric energy recovery device, the Flowserve FLEX is simple and cost-effective to integrate into new installations or retrofit existing plants.

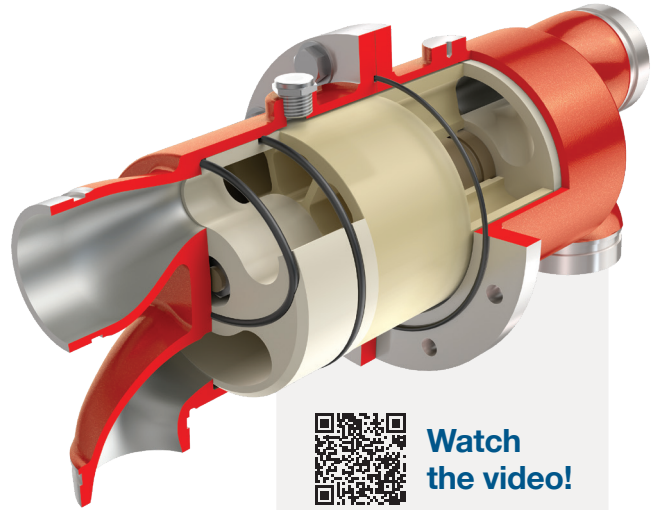

Flowserve FLEX 6300

Flows to: 68 m³/h (300 gpm)

Pressures to: 82 bar (1,200 psi)

Flowserve FLEX 8600

Flows to: 135 m³/h (600 gpm)

Pressures to: 82 bar (1,200 psi)



DWEER 1550 dual work exchanger

The DWEER system can recover up to 98% of the energy in the brine waste stream, making it the most efficient energy recovery device ever developed that also boasts low mixing and no leakage. Recovered energy is used to pressurize raw water, reducing the energy input you need for high-pressure feed pumps by 60%.

Pressures to: 82 bar (1,200 psi)



Energy recovery turbine impact machine

Energy recovery turbines are available in 50 and 60 Hz models for global applications. Flowserve can also manufacture custom-engineered products for applications outside this operating range. Seven standard models and diverse configurations are available.

Flows to: 1,200 m³/h (5,280 gpm)

Efficiency to: 90%

Pressures to: 80 bar (1,160 psi)



Pumps for SWRO

High-pressure membrane feed

All Flowserve high-efficiency membrane feed pumps (first and second pass) utilize the latest technology and are designed using computational fluid dynamics to provide the best system performance. These critical pumps are manufactured in corrosion-resistant materials to ensure long performance life without degradation. Horizontal split case (DMX-RO, DVSH-RO) or ring section (CSX, MS) models are available.

Configurations: Multistage or single-stage, between bearings

Materials: Duplex or super duplex stainless steels

Models: DMX-RO, DVSH-RO, CSX, MS

Flows: 7,000 m³/h (30,820 gpm)

Heads to: 1,000 m (3,281 ft)

ERD boosters

Flowserve high-pressure booster pumps are designed to operate efficiently under SWRO system pressure, where design pressures can exceed 82 bar (1,200 psi). Horizontal and vertical inline designs are available for these tough applications.

Configurations: High suction pressure, end suction designs

Materials: Super duplex stainless steels

Model: HHPX

Flows to: 4,000 m³/h (17,611 gpm)

Heads to: 90 m (295 ft)

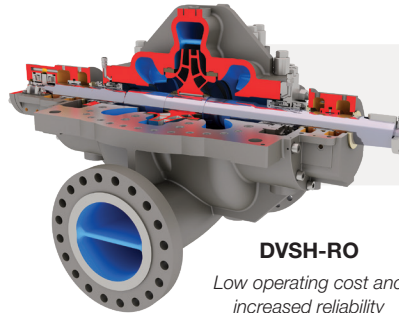

DVSH-RO

Low operating cost and increased reliability



Watch the video!

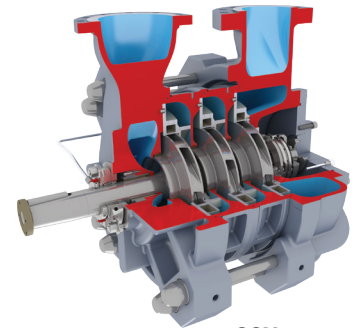

CSX

Long-term, high efficiency and low lifecycle cost

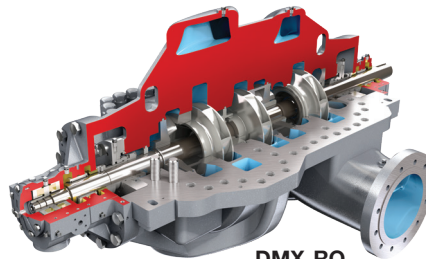

DMX-RO

Increased uptime and easy maintenance

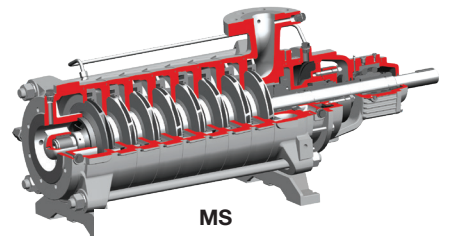

MS

High efficiency and long-term reliability

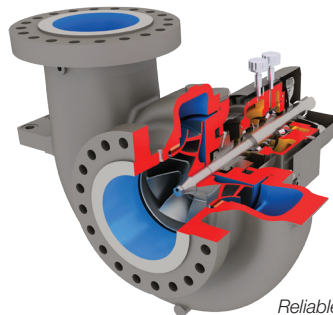

HHPX

Reliable performance under high pressure

Other services

Flowserve can provide pumping solutions for virtually all desalination plant support services. Pumps are available in various configurations and materials to meet the precise needs of your site.

- Filtered seawater
- Low-pressure feed booster
- High-pressure feed booster
- Product services
- Potable water
- Backwash
- Flushing pumps

Configurations: Single-stage, end suction or between bearings

Materials: 316 stainless steel, duplex or super duplex stainless steels; non-metallic materials

Models: DS-RO, LNN, Z Series, HPX

Flows to: 30,000 m³/h (132,000 gpm)

Heads to: 350 m (1,100 ft)

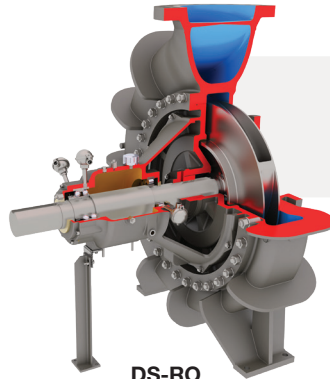

DS-RO

High efficiency and increased uptime



Watch the video!

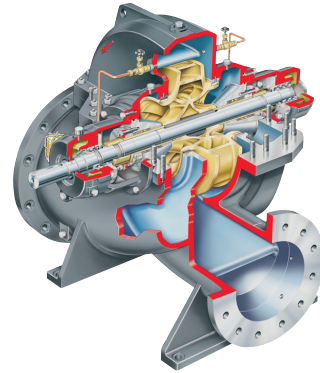

LNN

High efficiency and low NPSH requirements

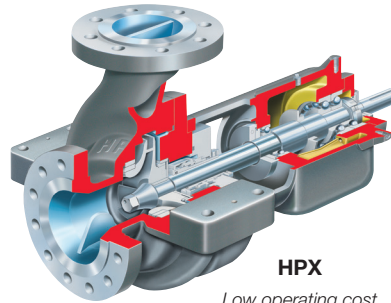

HPX

Low operating cost and longer service life

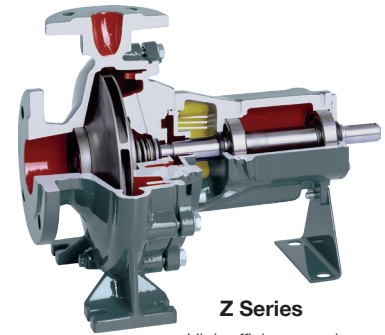

Z Series

High efficiency and extended reliability

Source water intake pumps

SWRO source water intake requires pumps that are corrosion-resistant and have the versatility to fit various intake methods. Flowserve offers several highly efficient vertical and horizontal pump models with proven performance to suit your application's needs.

Flowserve vertical source water intake pumps offer broad capacity ranges to maximize system efficiency while minimizing initial cost. Flowserve also offers horizontal pumps for dry-pit installation or space-saving vertical configurations which provide the same premium efficiency with a reduced footprint.

Configurations: Wet-pit and dry-pit

Materials: Duplex and super duplex stainless steels

Models: LNN, LNNV, VCT, VTP, SUBM

Flows to: 181,700 m³/h (800,000 gpm)

Heads to: 700 m (2,300 ft)

Assembly of 71APM VCT vertical pump

In 2013, the Flowserve operation in Coslada, Spain, assembled one of the largest vertical pumps in that location's history.



**Watch
the video!**

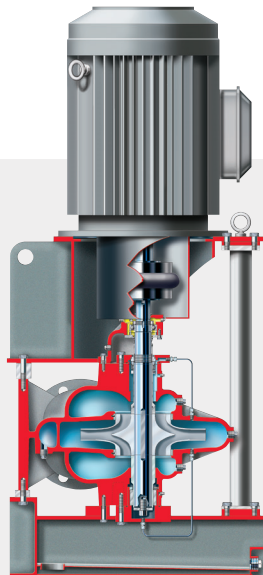

LNNV

*High efficiency and low
NPSH requirements*

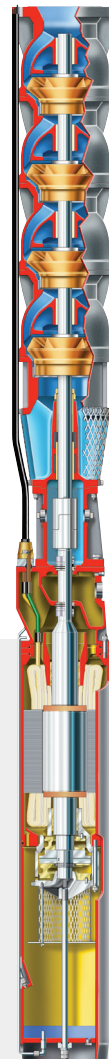

Byron Jackson® SUBM

Rugged, reliable and long-lasting

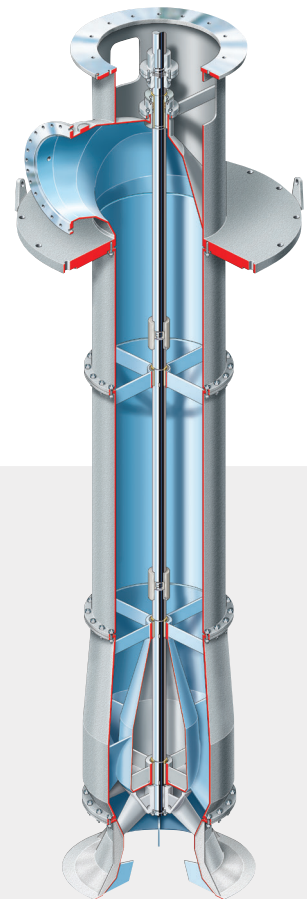

VCT

*Outstanding efficiency
and long service life*

ERD and pump application guide

Product Type	Product Model	APPLICATION														
		RO MEMBRANE											MSF/MED			
		Intake	Filter Feed	UF Filter Feed	UF Cleaning	Booster Pumps	ERD Booster	Energy Recovery	First Pass Membrane Feed	Second Pass Membrane Feed	Treated Water	DAF Pressurization	Seawater Intake	Brine Circulation	Blowdown	Distillate
Energy recovery devices	Flowserve FLEX							X								
	DWEER							X								
	ERT							X								
Vertically suspended, wet-pit	Byron Jackson SUBM	X														
	VTP	X														
	VCT	X										X				
	VPC												X	X	X	
	QLC												X	X	X	
Between bearings, single-stage	LNNV	X										X				
	LNN		X	X	X	X				X						
	DVSH-RO								X	X						
Between bearings, multistage	DMX-RO								X	X						
	CSX								X	X						
	MS								X	X						
Overhung	HPX							X		X						
	HHPX							X								
	DS-RO	X	X	X	X	X					X	X	X			
	Z-Series	X	X	X	X	X					X	X				

Mechanical seals for SWRO

Flowserve seals give your operation a competitive edge by extending the MTBF of critical rotating equipment. This advantage is made possible by industry-leading expertise in metallurgy and sophisticated mechanical sealing technologies designed to meet the challenges of SWRO.

Construction materials for mechanical seals used in SWRO applications include:

- Metal components:
 - Stainless steel for general water service
 - Flowserve Alloy for seawater, brine and chlorides
 - Super duplex is also available when specified
- Metal bellows:
 - Flowserve Alloy for all services
- Seal faces:
 - Carbon vs. silicon carbide for clean services
 - Silicon carbide vs. silicon carbide for services with solids or abrasives
 - Optional diamond coatings extend seal life

Plan 11 bypass flush from pump discharge is usually recommended. Additional cooling may be required for higher water temperatures.

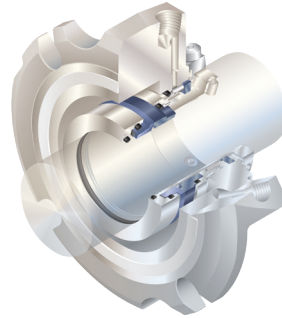

ISC2-PX
Single cartridge O-ring pusher seal for general applications

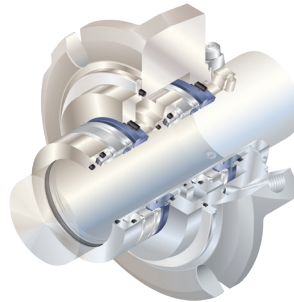

ISC2-BX
Single cartridge metal bellows seal for crystallizing fluid conditions

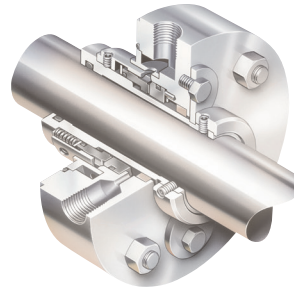

QB
Single cartridge O-ring pusher seal for higher-pressure requirements

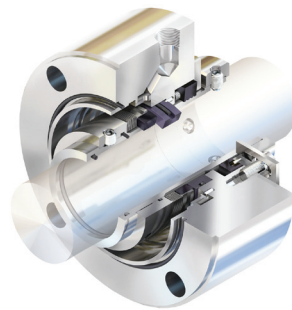

BX
Single cartridge metal bellows seal for higher-pressure crystallizing service

Valves for SWRO

Desalination processes, particularly SWRO systems, require numerous valves capable of handling large volumes of water at high pressures. These valves must also be made of materials capable of resisting corrosion from chloride-rich water and commonly used chemicals. Flowserve offers a complete range of valves and actuators to suit diverse desalination applications.

- Butterfly valves
 - Lined
 - Triple-offset
- Ball valves
 - Lined
 - High alloy material
 - Floating
 - Trunnion
- Plug valves
 - Lubricated
 - Non-lubricated
 - Lined
- Check valves
 - Tilting disk
- Service control valves
 - Linear globe/angle

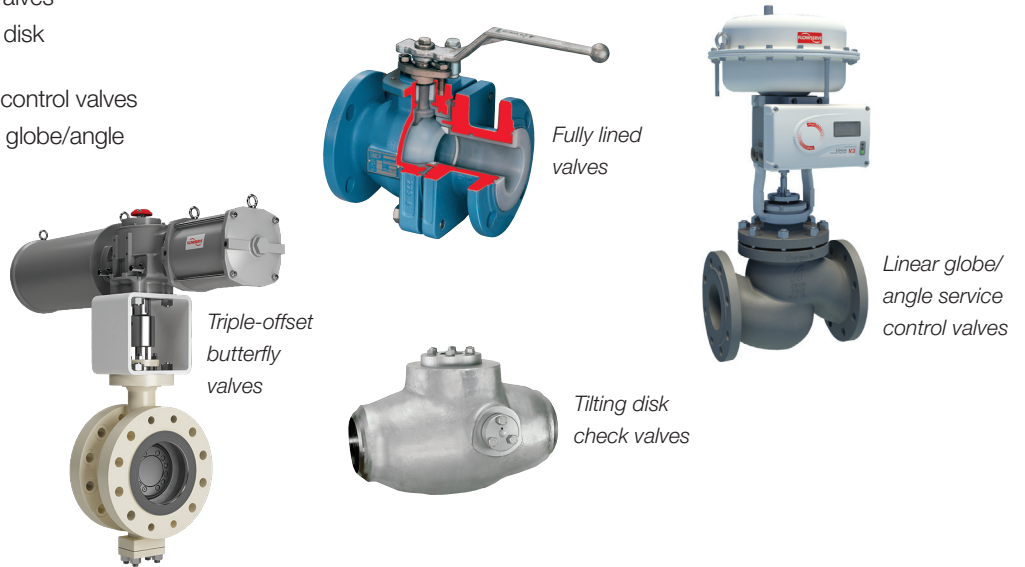

Actuators for SWRO

Whether you need fail-safe action, high-torque power or high-speed functionality, Flowserve actuators are built for the world's toughest jobs. Reliable operation, reduced maintenance and longer service life are made possible by the simplicity, efficiency and flexibility built into every design.

- Actuators
 - Electric
 - Pneumatic
- Positioners
 - Digital
 - Analog
- Switch boxes



Meeting your toughest desalination challenges

Expertise and Experience	<ul style="list-style-type: none"> • Flowserve has more than 50 years of experience in desalination • More than two out of three mega SWRO projects have Flowserve pumps and/or ERDs • Specialized “Center of Excellence” focusing on desalination
Single-Source Provider	<ul style="list-style-type: none"> • Optimizing equipment selections from early stage • Optimized overall efficiency of interacting products—pumps and ERDs • Specialized Desalination Center of Excellence • Less time evaluating • Reduced procurement activities
Streamlined Execution	<ul style="list-style-type: none"> • Global project management: <i>single-source supplier, flawless execution</i> • Simple communication and fast clarification channels • Reduced time to operation
Local Support	<ul style="list-style-type: none"> • Local support ensured through a global network of service centers • Support during installation and commissioning • Service and maintenance contracts for highest availability and continuous efficiency optimization • Support and repair ensured through local service centers • Upgrade opportunities through Desalination Center of Excellence • Full operation and service training
Optimizing Efficiency	<ul style="list-style-type: none"> • Highly efficient and reliable pump range for desalination • Reverse osmosis ERDs, with highest efficiency plus low mixing and leakage • Continuous Improvement Program (CIP) specifically for desalination • Optimized high-pressure feed pumps • Optimized ERD booster pumps • Optimized ERDs

Optional instrumentation

Flowserve desalination equipment is compatible with advanced condition monitoring, including the RedRaven predictive maintenance platform from Flowserve. RedRaven gives you the insights and tools you need to monitor, analyze and predict equipment performance so you can improve pump, valve and seal uptime while reducing maintenance and energy costs.

Ask your Flowserve representative about optional RedRaven monitoring packages or visit www.flowserve.com/redraven to learn more.



Dedicated local support, worldwide



Support when and where you need it most

You'll never have to look far for support, thanks to a robust global network of manufacturing facilities, design centers of excellence, strategically located Quick Response Centers and on-site resources.

Aftermarket services that deliver results

Over the last few decades, ERD, pump and membrane technologies have improved. Overhauling existing equipment with new reliability features, more efficient hydraulics or other upgrades can deliver meaningful improvements in plant efficiency, production and availability while reducing maintenance.

Upgrade opportunities include:

Brine concentrator — Add a booster pump skid with high-salinity membranes to increase production capacity and lower specific energy consumption (SEC).

Full retrofit — Combine membrane skids or add new ones to lower SEC and potentially increase production capacities.

Partial retrofit (ERT replacement) — Flow to the Flowserve FLEX depends on possible high-pressure membrane feed pump capacity, since the high-pressure membrane feed pump has to be powered with less ERT support.

Cascade retrofit — Use the Flowserve FLEX to feed added RO skid (with or without a booster pump) to increase plant capacity.

Predicting equipment performance

Traditional equipment monitoring methods — which rely on a find-and-fix approach — are outdated, inefficient and risky. These antiquated methods provide an incomplete view of your rotating equipment's health. Uncertainty leads to unplanned equipment downtime, which wrecks productivity, increases operating costs, and impacts your bottom line.

RedRaven predictive maintenance solutions from Flowserve make it easy for you to monitor and predict rotating equipment performance so you can take prompt actions when necessary to prevent unplanned downtime. With 24/7 insight into rotating equipment performance, you can focus on what really matters.



Flowserve Corporation
5215 North O'Connor Blvd.
Suite 700
Irving, Texas 75039-5421 USA
Telephone: +1-937-890-5839

Flowserve Spain S.L.
Avenida Fuentemar 26/28.
28823 Coslada, Madrid, Spain
Telephone: +34-91-660-4600

Flowserve Corporation has established industry leadership in the design and manufacture of its products. When properly selected, this Flowserve product is designed to perform its intended function safely during its useful life. However, the purchaser or user of Flowserve products should be aware that Flowserve products might be used in numerous applications under a wide variety of industrial service conditions. Although Flowserve can provide general guidelines, it cannot provide specific data and warnings for all possible applications. The purchaser/user must therefore assume the ultimate responsibility for the proper sizing and selection, installation, operation, and maintenance of Flowserve products. The purchaser/user should read and understand the Installation Instructions included with the product, and train its employees and contractors in the safe use of Flowserve products in connection with the specific application.

While the information and specifications contained in this literature are believed to be accurate, they are supplied for informative purposes only and should not be considered certified or as a guarantee of satisfactory results by reliance thereon. Nothing contained herein is to be construed as a warranty or guarantee, express or implied, regarding any matter with respect to this product. Because Flowserve is continually improving and upgrading its product design, the specifications, dimensions and information contained herein are subject to change without notice. Should any question arise concerning these provisions, the purchaser/user should contact Flowserve Corporation at any one of its worldwide operations or offices.

©2023 Flowserve Corporation. All rights reserved. This document contains registered and unregistered trademarks of Flowserve Corporation. Other company, product, or service names may be trademarks or service marks of their respective companies.

MULTIBR000155-14 (EN/AQ) March 2023
(Formerly FPD-18)