

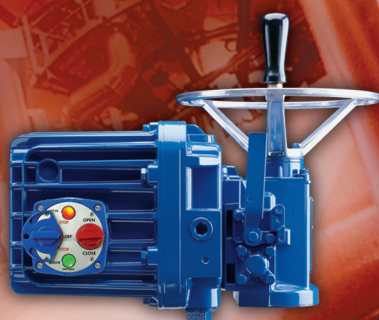

Limitorque® Valve Actuation Systems

Electric and Fluid Power
Actuators and Control Systems

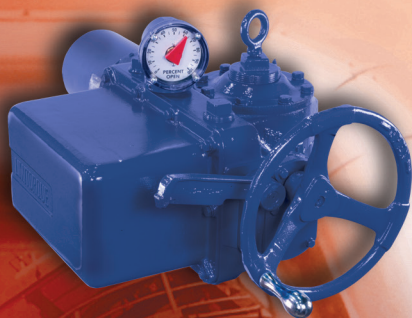
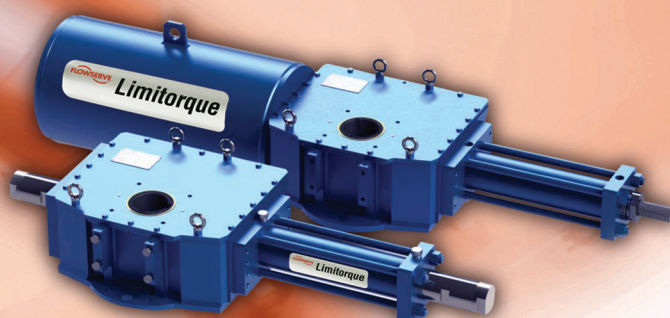

Experience In Motion



Flowserve: Solutions to Keep You Moving

Flowserve is one of the world's leading providers of fluid motion and control products and services. Globally, we produce engineered and industrial pumps, valves, seals, systems and automation equipment, and provide a range of related flow management services. Our solutions move even the most volatile and corrosive fluids safely and securely through some of the most extreme temperatures, terrain and challenging operating environments on the planet. Flowserve markets are large, diverse and worldwide. Our products and services are specified for use in a vast range of industries, including oil and gas, chemical, power generation and various general industries.

Changing the Valve Control Industry

In the 1920s, Payne Dean, an emigré inventor from England, was issued a U.S. patent for a machine with the unique ability to sense and subsequently limit output torque in a controlled manner. This "limit the torque device," or Limatorque, fundamentally changed the valve control industry. Today, all heavy-duty electric actuators employ some method that limits torque in order to safely operate automated valves while protecting people and property.

In 2012 Flowserve established the Limatorque Fluid Power Systems team with the expressed mission to develop a comprehensive line of fluid power valve actuators that meet the oil and gas industry's most current and stringent standards for safety, performance and reliability. Unlike the modified or re-purposed actuators offered by competitive manufacturers, the engineers specifically designed and built heavy-duty, fluid-power, piston-type Scotch yoke actuation for rotary and linear valve operation.





Limitorque Timeline

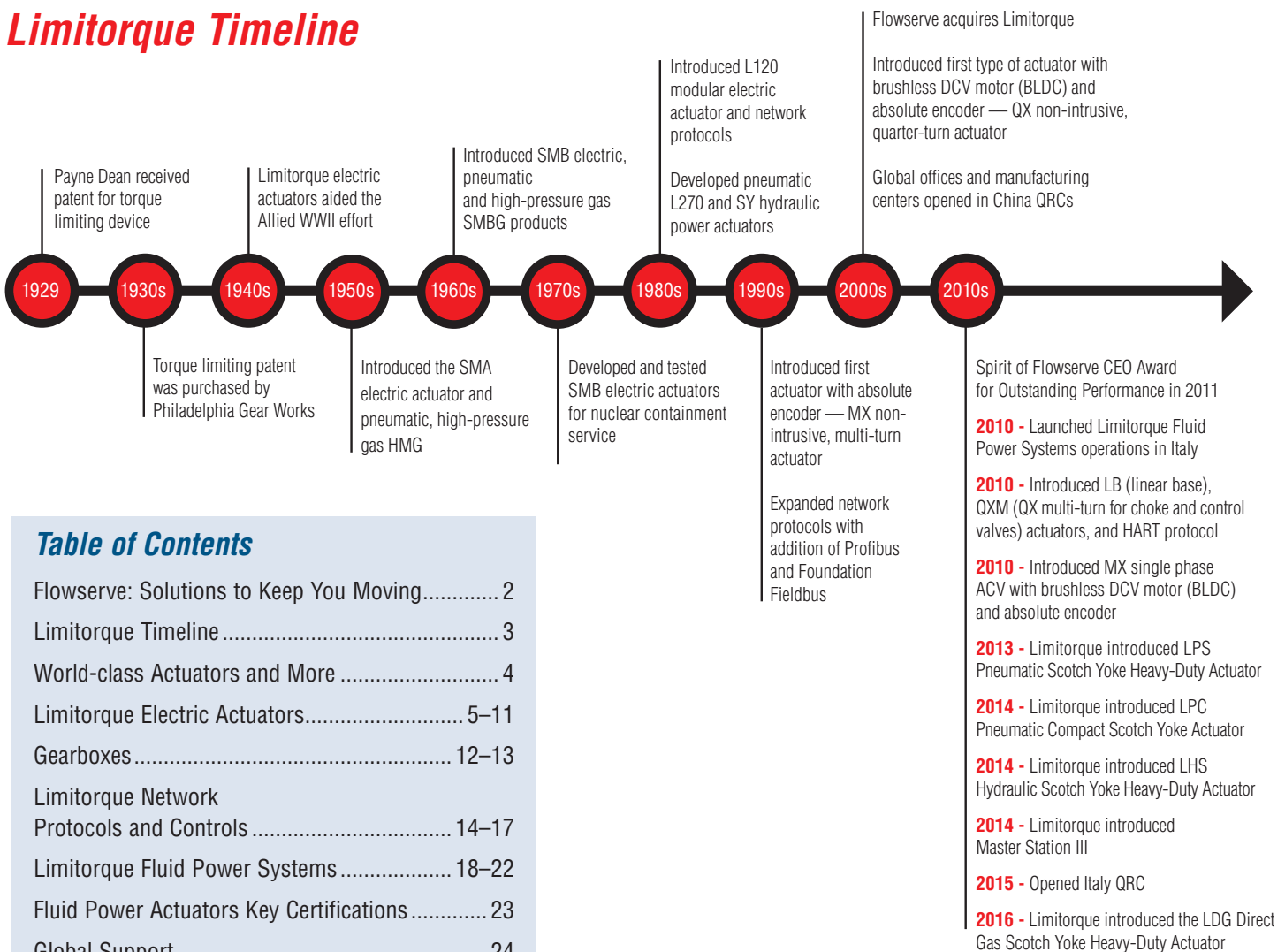

Table of Contents

Flowserve: Solutions to Keep You Moving..... 2

Limitorque Timeline 3

World-class Actuators and More 4

Limitorque Electric Actuators..... 5–11

Gearboxes 12–13

Limitorque Network
Protocols and Controls 14–17

Limitorque Fluid Power Systems 18–22

Fluid Power Actuators Key Certifications 23

Global Support 24

World-class Actuators and More

Flowserve Limitorque Products

Flowserve Limitorque products help make valve control easier in ways as diverse as the applications in which they are used. Whether you need an electric actuator with the strength to handle 2224 kN (500 000 lb) of thrust, a fluid power actuator to deliver 300 kNm (221 270 ft-lb) or more of torque or a sophisticated control network to precisely orchestrate hundreds of valves, you will find that Limitorque products make the task easier. With almost 90 years of experience in the field of valve control, Flowserve Limitorque understands the particular needs of customers in every major industrial segment. Limitorque actuators are at work in hundreds of thousands of sites around the world, reliably automating valves in some of the harshest conditions imaginable: from scorching desert sands to frozen tundra, from rainforest humidity to the stormy salt spray of offshore oil rigs. Automating industrial valves can help increase safety, raise productivity and reduce operating costs. You can rely on Flowserve Limitorque for extraordinary electric or fluid power actuated valve control.



A Comprehensive Range of Actuators and Controls

Flowserve Limitorque offers its customers a complete menu of proven automation products:

- The unexcelled Limitorque range of heavy-duty electric actuators along with fluid power actuators, designed to meet the arduous demands of the oil and gas industry
- Excellent operating efficiencies for applications from control room performance sequencing and continuous process optimization to configuration for ESD (emergency shutdown) and SIL-rated safety requirements
- A full suite of digital network protocols delivering visibility of diagnostics and configurations



Limitorque Electric Actuators

Limitorque's range of electric products leads the valve automation industry with innovative products and state-of-the-art solutions. They are available for both multi-turn and quarter-turn operation in the most demanding environmental conditions, with non-intrusive designs offering a full complement of network controls and options, or basic intrusive actuation for simplified control applications.

State-of-the-art, Non-intrusive Actuation

The Flowserve Limitorque QX quarter-turn and MX multi-turn electronic valve actuators lead the industry in quality, safety and ease of use. Both models provide the user with predictable, reliable and safe operation plus extended service life, in the most rigorous applications and extreme environments.



Upon its introduction the MX included innovations that were “market firsts.” The latest MX and QX generations have improved on these versions by adding:

- Non-intrusive design employing selection knobs with solid state Hall-effect devices instead of electro-mechanical reed switches
- Non-contacting, optical and “system on a chip” absolute encoders for accurate position sensing
- Batteries-not-required design for the absolute encoder to retain position data in the event of loss of main power, thus eliminating the need for costly battery maintenance programs or the potential loss of equipment availability due to battery failure
- BIST (BUILT-IN-SELF-TEST) absolute encoders including redundant position sensors and comparator logic for increased reliability and safety
- LimiGard™ technology featuring internal logic that validates the bandwidth of incoming external commands to prevent actuator malfunctions. LimiGard ensures a Fail/No Action operation.
- Graphical display for access to operational data in 11 languages
- Optional Bluetooth® wireless connectivity

Limitorque Electric Actuators

MX Multi-turn, Non-intrusive Actuator

Flowserve Limitorque introduced the MX electric actuator in 1997 as the first smart actuator providing uncompromised reliability and performance in an easy-to-use design.

The next generation MX improves on its market-first innovations: a unique absolute encoder that does not require battery backup; LimiGard technology; easy-to-use menus in 11 languages; and the use of Hall-effect devices to eliminate potentially troublesome reed switches. Altogether, these enhancements provide predictable, reliable and safe operation in the most extreme applications.

The MX includes an absolute encoder with increased span, improved diagnostics capability and built-in self-test (BIST), which verifies and validates the integrity of its components. The reliability of an absolute encoder along with BIST is a major reason that the MX is certified by exida® Certification as capable for use in up to SIL 3 applications. No additional hardware is needed to make the MX SIL capable. Another MX feature, MX Quik, provides an uninterrupted power transfer option during main power losses. This further strengthens the MX position as the only smart actuator with “no batteries required.”

HART protocol is now a communication option to complement Modbus, Foundation Fieldbus H1, PROFIBUS DP_V1 with redundancy, PROFIBUS PA and DeviceNet. Eleven languages are supported, including English, Spanish, French, Italian, German, Portuguese, Japanese (Katakana), Mandarin, Russian, Malay and Turkish. A Device Type Manager (DTM) is also available for Profibus, HART and Foundation Fieldbus.



The MX can be directly mounted to any rising or non-rising stem valve. When combined with a Limitorque WG or HBC series worm gearbox, it can be used to control butterfly, ball and plug valves, as well as damper drives, flop gates or similar devices. MX actuators can also be coupled with Limitorque V series bevel gearboxes or SR series spur gearboxes for motorized operation of multi-turn valves when extended operating times or reduced motor current requirements are required.

The MX uses synthetic oil lubrication, and is suitable for service in temperatures ranging from -60°C (-76°F) to 65°C (150°F). MX actuators are submersible to 15 m (49 ft) for 96 hours under the IP68 standard and are certified for installation into global hazardous environments by Factory Mutual, Canadian Standards Association ATEX and IECEx requirements.

These features, along with an improved graphical dot-matrix display, optional Bluetooth wireless connectivity and the Dashboard Software suite, truly make the MX the next generation in smart actuation.

Actuator Model	Max Torque		Max Thrust		Output Speed
	ft-lb	Nm	lb	kN	RPM
MX-05	55	75	8000	35	15–200
MX-10	125	170	15 000	66	15–200
MX-20	225	305	25 000	111	15–200
MX-40	440	597	36 000	160	15–200
MX-85	1225	1662	50 000	222	22–170
MX-140	1700	2307	75 000	333	22–170
MX-150	1500	2036	75 000	333	165–200

Limitorque Electric Actuators

Limitorque MX Single Phase ACV

Flowserve Limitorque introduced the innovative MX electronic actuator with technical features that were market firsts – a patented absolute encoder, patented Limigard technology, and easy-to-use menus in multiple languages. These features and the implementation of a BLDC (brushless DCV) motor were included in the feature-rich QX quarter-turn electronic actuator. All of the innovative features devised for the MX and QX are now combined in the single phase ACV MX, including a BLDC motor. This means the same predictable, reliable and safe operation users have come to expect from the MX/QX actuators are now found in the single phase ACV MX. The 100% solid-state, single-phase MX with BLDC motor includes the following feature set:

- Patented absolute encoder with increased span, improved diagnostics capability, a redundant encoder with (BIST, Built in Self Test) testing for position sensing, part of Flowserve Limitorque’s uncompromising commitment to “no batteries required.”
- State-of-the-art controls platform which incorporate BIST and monitors the integrity of its components, resulting in a design that can provide a high level of safety.

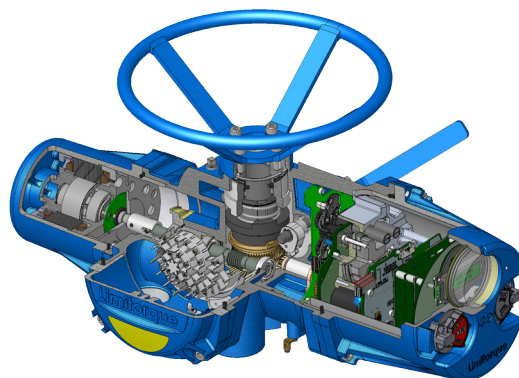

- Improved network communications with the addition of HART protocol to complement Modbus, Foundation Fieldbus H1, Proibus DP_V1 and Profibus PA and DeviceNet.
- User can connect any single phase ACV from 110V up to 250 Vac, without changing the MX motor or electronics, providing quick and easy connectivity in the field.

Output Speed (RPM)		Rated Output Torque			
		MX-05		MX-10	
60Hz	50 Hz	ft-lb	N m	ft-lb	N m
18	15	55	75	125	170
26	22	55	75	125	170
40	33	55	75	125	170
52	43	55	75	125	170
77	65	48	65	107	145
100	84	39	53	89	121
155	127	41	56	89	121
200	165	34	46	73	99

Limitorque Electric Actuators

QX Quarter-turn Actuator and QXM Limited Multi-turn, Non-intrusive Actuators

QX

The Flowserve Limitorque QX quarter-turn, smart electronic valve actuator mimics the state-of-the-art, multi-turn MX actuator by including a unique absolute encoder for tracking position without the use of batteries.

The QX design provides enhanced safety and reduced downtime through improved diagnostics, built-in self-test (BIST) features and LimiGard fault protection.

The QX design builds on almost 20 years of experience with proven Limitorque MX technology — the first-generation, double-sealed electronic valve actuator from Flowserve designed to provide control, ease of use and accuracy. The QX includes all the user-preferred features of the MX in a quarter-turn, smart actuator package.

Actuator Model	Max Torque		Operating Speed (Seconds)
QX-1	100	136	5–20
QX-2	250	339	8–30
QX-3	400	542	15–60
QX-4	750	1017	30–120
QX-5	1500	2033	60–120

Actuator Model	Max Torque		Max Thrust		Output Speed	
	ft-lb	Nm	lb	kN	Seconds	RPM
QXM-1	100	135	9065	40	130–400	3
QXM-2	250	339	N/A		195–600	2
QX-1/MH6	90	122	8159	36	65–200	6
QX-1/ML6	45	61	3173	14	65–200	6
QX-1/MH12	78	106	7071	31	33–100	12
QX-1/ML12	48	65	5786	26	33–100	12
QX-1/MH18	55	75	4986	22	22–67	18
QX-1/ML18	33	48	4080	18	22–67	18
QX-1/MH24	38	52	2538	11	16–50	24
QX-1/ML24	22	30	2077	9	16–50	24



QXM

The industry-leading feature set of the QX has been extended to a multi-turn version, the QXM. The QXM is available for up to 20 drive sleeve turns, with speed ranges from 6–24 RPM. When combined with faster speeds, the torque ranges are consistent with the speed required for limited linear travel. All of the MX and QX features are included in the QXM. An optional A1 base can be attached to the QXM to accept multi-turn valve thrust. A linear base is also available for mounting to valves that require more precise process control. It is designed in conjunction with EN 15714, Electric Actuators for Industrial Valves. The QXM has been tested to the Class D, continuous duty modulating requirements of EN 15714 and is capable of modulating up to 1800 starts per hour.

Continued on next page

Limitorque Electric Actuators

QX Quarter-turn Actuator and QXM Limited Multi-turn, Non-intrusive Actuators

Continued from previous page

Brushless DC Motors

The QX family of actuators was the first non-intrusive actuator to employ advanced brushless DC motors. BLDC motors eliminate sparks, reduce mechanical and electrical noise, and dissipate heat better than motors with brushes. The brushless actuator design lasts longer than conventional motors and allows for more accurate positioning while permitting a global range of voltages (single-phase and three-phase ACV and DCV) to be connected without modification.

Other features include a graphical dot-matrix display allowing 180-degree rotation and supporting 11 languages: English, Spanish, French, Italian, German, Portuguese, Japanese (Katakana), Mandarin, Russian, Malay and Turkish.



Optional Bluetooth wireless connectivity with a range up to 10 meters enables easy transfer of diagnostic information to a PDA or laptop computer when used with Flowserve Limitorque Dashboard Windows®-based software.

Network communications such as Modbus, Foundation Fieldbus H1, DeviceNet, HART, Profibus DP_V1 redundancy and Profibus PA offer the user remote accessibility to a vast array of status alarm and diagnostic data that is embedded in the QX. A Device Type Manager (DTM) is also available for Profibus, HART and Foundation Fieldbus.

Limitorque Electric Actuators

Limitorque Intrusive Electric Actuators

L120 Multi-turn Actuator

The Flowserve Limitorque L120 series, with more than 25 years of field-proven reliability, is a long-standing product of choice for any valve requiring either rotary or linear actuation. Regardless of the valve design, the L120 performs consistently and predictably in any situation demanding positive, dependable control.

The L120 can be directly mounted to any rising or non-rising stem valve. When combined with a Limitorque WG or HBC series worm gearbox, it can be used to control butterfly, ball and plug valves, as well as damper drives, flop gates or similar devices. For motorized operation of multi-turn valves when extended operating times or reduced motor current requirements are required, L120 actuators can be coupled with Limitorque V series bevel gearboxes or SR series spur gearboxes.

For high-speed or high-temperature applications, the L120-190, 420 and 800, covering thrust requirements from 334 to 1112 kN (75 000 to 250 000 lb) and torque requirements from 2584 to 10 846 Nm (1900 to 8000 ft-lb), are available with spring compensation packages for high-speed temperature applications.



The L120 is factory-lubricated, suitable for weatherproof service in temperatures ranging from -40°C (-40°F) to 65°C (150°F), as well as explosion proof and temporary submersion applications. Weatherproof enclosures meet NEMA 4 standards, as well as NEMA 6, IP67, and IP68 submersible standards. Explosionproof actuators meet Factory Mutual and Canadian Standards Association requirements.

Basic integral control packages and the UEX electronic control package with MX-style functionality are also available. The UEX offers optional digital communication boards for the five supported network protocols available with the MX and QX.

Actuator Model	Max Torque		Max Thrust		Output Speed
	ft-lb	Nm	lb	kN	RPM
L120-10	100	136	10 000	45	10–250
L120-20	200	272	20 000	90	10–250
L120-40	400	544	30 000	135	20–250
L120-85	850	1156	45 000	203	20–192
L120-190	1900	2584	75 000	338	20–196
L120-420	4200	5712	140 000	630	16–196
L120-800	8000	10 880	250 000	1125	10–168
L120-2000	20 000	27 200	500 000	2250	10–60

Limitorque Electric Actuators

SMB Multi-turn Actuator

With more than 50 years of proven performance and reliability, the eight models in the Flowserve Limitorque SMB series offer rugged dependability from the smaller SMB-000 through the industry's largest electric valve actuator, the SMB-5XT. An extensive gearing selection for each actuator size delivers unmatched versatility for meeting exacting operating speed requirements. Three-phase, single-phase, pneumatic and DC motors are available to meet wide ranges of power and speed. Optional controls include an integral reversing starter and control voltage transformer package, an actuator-mounted control station, and position indication feedback.

The SMB is well suited to applications involving gate and globe valves, sluice gates and other applications where long-term, uncompromised, reliable operation is critical. Fully qualified for use in nuclear power generating plants, the SMB is the recognized veteran of the nuclear power industry. The SB, a high-speed, high-temperature version of the SMB, is also available. The SMB, when coupled to the V or SR series gearboxes for multi-turn applications, or with the HBC or WG for quarter-turn valve applications, can be counted on to provide long-lasting performance.



For critical and/or severe service, the decades-long history of reliable and dependable performance clearly demonstrates the lasting value of SMB and SB actuators.

The more severe the service, the more rugged the electric actuator required to withstand and reliably work in that environment. The SMB has a long-standing and well known reputation for performance in harsh environments like those in refinery coker units. The SMB has decades of proven performance in these types of difficult applications.

Actuator Model	Max Torque		Max Thrust		Output Speed
	ft-lb	Nm	lb	kN	RPM
SMB-000	120	163	8000	36	12-250
SMB-000	260	353	14 000	62	10-250
SMB-000	700	949	24 000	107	10-250
SMB-1	1100	1491	45 000	200	10-250
SMB-2	1950	2644	70 000	311	10-250
SMB-3	4200	5694	140 000	623	10-250
SMB-4	8300	11 253	250 000	1112	10-250
SMB-5	20 000	27 116	500 000	2224	12-55
SMB-5XT	60 000	81 350	N/A	N/A	12-55

Gearboxes

Limitorque Worm Gear, Bevel Gear and Spur Gearboxes

WG Worm Gearboxes

WG gearboxes are designed to meet the performance requirements and environmental challenges for manual and motorized applications. When combined with Limitorque electric actuators such as the MX, L120 or SMB, the WG quarter-turn, 90-degree and multi-turn, 360-degree gearboxes provide the user with dependable, efficient and economical solutions for valve and damper applications. The WG delivers extraordinary valve and damper control in a wide range of output torques and gearing selections.

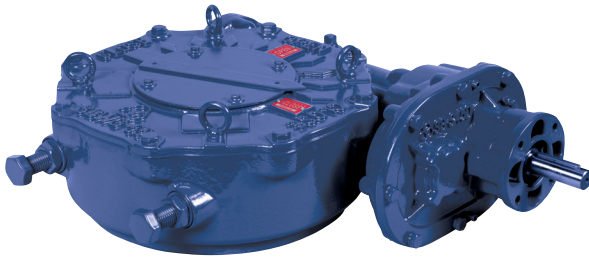

Max Torque	
ft-lb	Nm
449 900	610 000



V Series Bevel Gearboxes

The V series of bevel gearboxes offers an extensive range of thrust and torque outputs for multi-turn applications such as gate and globe valves, and slide gates.

Whether controlled manually or motorized with MX, L120 or SMB actuators, V series gearboxes are ideal for any multi-turn application requiring accurate, reliable performance. V gearboxes are suited for weatherproof and temporary submersion applications. The top entry, splined, bronze alloy stem nut is removable from the drive sleeve for thread machining. For very high thrust loads the VH version is available, featuring a bolt-on thrust base with removable stem nut.

Max Torque		Max Thrust	
ft-lb	Nm	lb	kN
38 353	52 000	1 719 800	7650

Gearboxes

SR Spur Gearboxes

The SR series spur gearbox is designed for multi-turn applications for gate and globe valves, and slide gates. The well-designed SR has a top-entry bronze stem nut that is easily removed for thread machining. Ductile iron housings and bearing-supported shafts provide high strength and durability.

SR gearboxes are sealed for weatherproof and temporary submersion applications. When motorized by the Limitorque MX, L120 or SMB electric actuators, the SR delivers reliable operation for a wide range of thrust and torque loads. SRH gearboxes are available for very high thrust loads, with a bolt-on thrust base and removable stem nut.

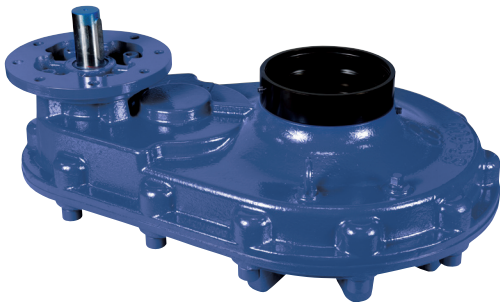

Max Torque		Max Thrust	Max Thrust
ft-lb	Nm	lb	kN
9588	13 000	519 300	2310

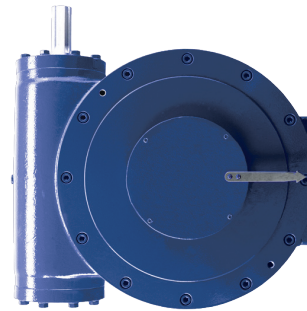

HBC Worm Gearboxes

HBC worm gearboxes have proven their rugged dependability in the nuclear power industry, large damper operations, and power plant flue gas desulphurization applications. Whether controlled manually or with MX, L120 or SMB actuators, HBCs are the right choice for any quarter-turn or multi-turn application requiring accurate, reliable, uncompromised performance. They are commonly used with butterfly, ball and plug valves in power plants, petrochemical installations, pipelines, and water and wastewater treatment facilities. HBCs are available in weatherproof, buried service and submersible constructions.

Max Torque	
ft-lb	Nm
93 000	126 090

Limitorque Network Protocols and Controls

Master Station III

The next-generation master station is designed specifically for use with Limitorque's line of DDC (Modbus) electric actuators. For power, petrochemical, oil and gas, water and wastewater applications, the Master Station III acts as a single-source controller for up to 250 actuators.

The Master Station III is a plug-and-play solution that provides complete control and diagnostics for Limitorque MX, QX, and L120 actuator field units through a simple touch-panel operator interface.

The MSIII offers many key features, including a network time protocol to allow for time synchronization of alarms and diagnostic data to the host device. Intended

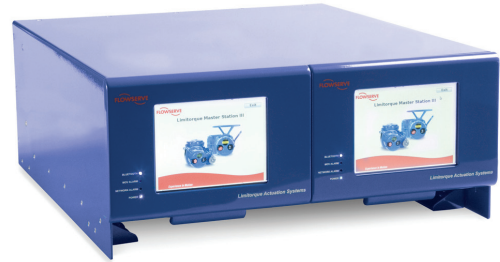

for global deployment, multilingual support for English, Spanish, German, French and Italian is standard.

Configuration of the field device register polling schedule provides optimized accessibility to critical networked data using industry standard Modbus RTU or TCP/IP protocols. Three levels of user password protection, entered in to the 40 mm (5.6 in) TFT touch-screen display, allow for varying levels of access to status, configuration and control features, such as email notification of configurable alarm conditions, data/event logging, and control of up to 250 devices.

A user-friendly hardware package provides front access to multiple peripheral ports: Ethernet, USB x 2, VGA and printer/debug. The hardware also offers a modular hot-swappable redundant design to prevent downtime during service.

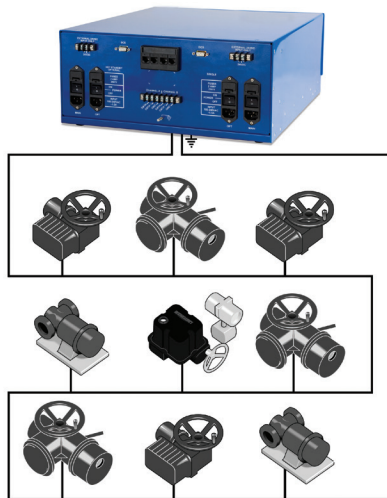

Limitorque Network Protocols and Controls

DDC (Modbus)

The DDC (Modbus) valve control network efficiently connects as many as 250 valve actuators directly to an existing host system without adding hardware or new equipment. The network's design also reduces the costs of engineering, cable and installation.

With a simple and reliable communications path between the host system and the network, actuators and other devices (such as pumps and solenoids) can be efficiently automated and monitored from a central control room.

The system's open architecture is compatible with Modbus RTU and ASCII transmission modes, protocols and communication standards, and is easily expanded to include MX, QX, and L120 actuator field units. Limitorque's partnerships with host suppliers ensure that connection and programming can be smoothly accomplished with minimal equipment, effort and cost.

The Limitorque DDC (Modbus) direct-to-host network simplifies valve operation, enhances control and reduces costs.

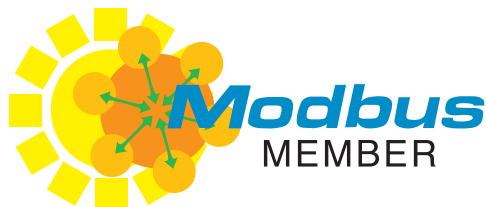

DeviceNet

DeviceNet is a digital, trunk/drop network that serves as a digital communication network between host controllers and MX/QX actuators. Up to 63 actuators can be connected by a single five-strand, twisted-pair cable to form a DeviceNet network. DeviceNet follows the Open Systems Interconnection (OSI) model, an ISO standard for network communications, and is another communication option of the MX, QX, and L120 actuators. DeviceNet offers the user bit-strobe I/O messaging and a host of other benefits.

Limitorque Network Protocols and Controls

Foundation Fieldbus H1

Limitorque's Foundation Fieldbus H1 interface for MX, QX, and L120 actuators uses an all-digital, serial, two-way communications system to permit a truly field-distributed control system.

Standard Function Blocks for Analog Output (AO), Digital Output (DO), Digital Input (DI), and Proportional-Integral-Derivative (PID) are used to easily integrate the actuator into the plant control system. These standard Function Blocks permit a seamless interface to control and monitor the actuator with other field instrumentation for increased visibility and control of the plant processes.

Other features of Foundation Fieldbus (FF):

- Increased visibility of actuator status, alarms and diagnostics
- Reduced wiring and wire terminations
- Ease of configuration
- Open standard, non-proprietary fieldbus protocol

The FF field unit may command its actuator to open, stop, close, move to a set position or perform an emergency shutdown operation. Commands to the field unit come over the network from the host system, which may be a PC, distributed control system (DCS), programmable logic controller (PLC) or some other microprocessor-based device. Commands may also be generated in another network actuator or device and transmitted over Fieldbus using publisher/subscriber communication.

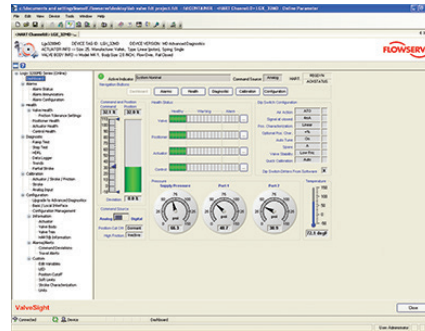

ValveSight DTM

Profibus, HART and FF field units support Device Type Manager (DTM) technology via a software component that contains device-specific application information. The DTM can be integrated into Field Device Tool (FDT) frame applications, such as stand-alone commissioning tools or asset management systems that are equipped with FDT interfaces. FDT technology is independent from any specific communication protocol, device software or host system, allowing any device to be accessed from any DCS host through any protocol.

- Reduces commissioning time, maintenance and related operating costs
- Improves productivity by providing a user-friendly graphical interface
- Increases efficiency by enabling network users to communicate in real time with the device and, thus, monitor diagnostics information, including alarms
- Interfaces for offline and online parameterization, configuration, reading status and diagnostic data



Limitorque Network Protocols and Controls

PROFIBUS PB DPV1/PA

The PROFIBUS (PB) field unit is another option for networking and communicating with MX, QX, and L120 actuators. The PROFIBUS communications system is a digital, serial, two-way open bus system that supports a variety of communication rates. The PB field unit allows the actuator to send multiple variables to the control system over a high-resolution and distortion-free digital communication network, providing control and self-test capabilities. This system allows a network host station such as a distributed control system (DCS) or a programmable logic controller (PLC) to control and monitor up to 126 MX, QX, and L120 actuators, including the acquisition of status and alarm data from each actuator.

The PB field unit supports two different communication board options:

- PROFIBUS DP, now available with DTM technology, is designed for redundant or non-redundant communication between a master host station and distributed devices at the field level
- PROFIBUS PA, which is also available with DTM technology, is designed for high-speed and reliable communications, along with the ability to link sensors and actuators to a common fieldbus line, even in potentially explosive areas

A PROFIBUS DP and PA Device Type Manager (DTM) are available to serve as an interface between the MX and QX application software and a host's Field Device Tool (FDT) frame. The DTM can be integrated into FDT frame applications to allow users to perform offline and online parameterization, configuration, and status and diagnostic retrieval.

Limitorque MX/QX HART (Highway Addressable Remote Transducer)

The HART network employs a bi-directional communication protocol, operating at 1200 bits/sec that provides data access among intelligent devices such as Limitorque MX, QX, and L120 electronic actuators and a digital control system (DCS) and/or other monitoring systems. In addition to a digital system, the network simultaneously provides a 4-20 mA analog signal that is proportional to the field unit's primary measured value.

Features and Benefits

The following commands and feedback information can be transmitted and received by an MX/QX HART unit:

- OPEN, CLOSE and STOP commands
- ESD (emergency shutdown) commands
- Partial stroke test (PST) commands
- Go-to-position commands
- Unit output torque (0–100% rating)
- Actuator status, alarm and diagnostic messages
- Burst messages
- Travel histogram
- Event notifications
- LimiGard patented signal monitoring

Limitorque Fluid Power Systems

Limitorque is dedicated to providing heavy-duty, fluid-powered valve actuators and control systems for the oil and gas industry. Every product accounts for the most recent and stringent industry standards for safety and service life, providing users with unprecedented operating life and maintenance intervals.

LPS Pneumatic Quarter-turn Scotch Yoke Actuators

Equipment performance and safety standards continue to evolve and increase across the infrastructure industries. To more aggressively meet these demands, Flowserve Limitorque is offering the LPS pneumatic Scotch yoke actuator — specifically designed to meet or exceed the latest and most rigorous of these requirements.

Features and Benefits

- True modular design permits the flexibility of configuring the actuator in either clockwise (CW) fail close or counter-clockwise (CCW) fail open configurations as needed, including in the field, if necessary
- Fabricated carbon steel Scotch yoke housing, pneumatic cylinder and spring can provide the most rugged actuator available; different construction materials for polar or offshore applications available upon request
- Suitable for use in on/off, modulating and control valve application in general service, protective service and safety applications such as Emergency



Shut Down (ESD) or High Integrity Pressure Protection System (HIPPS)

- Symmetrical and canted Scotch yoke types to perfectly fit valve torque requirement
- End mounted adjustable travel stops $\pm 5^\circ$, available also in enclosed protected version upon request
- Available in standard single-acting spring return and double-acting configurations, in torque ranges up to 300 kNm (221 270 ft-lb); contact factory for larger sizes
- 12 barg (174 psig) maximum allowable working pressure (MAWP)
- -29°C to 100°C (-20°F to 212°F) standard operating temperature range; Low temperature -60°C (-76°F) and high temperature 160°C (320°F) ranges available upon request (polar, cold, arid and tropical temperature requirements in accordance with IEC 60721)
- SIL 3 certified in accordance with IEC 61508
- Full range of accessories: switchboxes; positioners; ESD, PST and line-break functionality; custom control panels; fire protection; manual and hydraulic overrides

Model	MOT Maximum Operating Torque Nm (ft-lb)	MOP Maximum Operating Pressure barg (PSIG)	MAWP Maximum Allowable Working Pressure barg (PSIG)
LPS-15	6000 (4425)	Variable for every cylinder size	12 (174)
LPS-20	12 000 (8850)		
LPS-25	21 000 (15 489)		
LPS-30	40 500 (29 871)		
LPS-35	75 000 (55 317)		
LPS-40	150 000 (110 634)		
LPS-50	300 000 (221 268)	Consult Factory	
LPS-60	Consult Factory		

Limitorque Fluid Power Systems

LPC Compact Pneumatic Scotch Yoke Actuators

The Limitorque Pneumatic Compact (LPC) Scotch yoke is a robust yet lightweight, modular, pneumatic, piston-type actuator design, with nodular ductile cast iron or carbon steel housing and carbon steel ENP cylinders. The LPC actuator is available in both spring-return and double-acting configurations, with an easy field conversion feature from Fail Close Clockwise to Fail Open Counter-Clockwise. With a maximum allowable working pressure of 12 barg (174 psig), it is ideally suited for smaller size valves and those requiring less than 5500 Nm (4057 ft-lb) of maximum output torque. The LPC is fully complementary to the LPS, employing a similar design philosophy and meeting the same industry specifications, but in a more, lower cost package.

Features and Benefits

- Symmetrical and canted Scotch yoke types to perfectly fit valve torque requirement
- Easy field conversion from Fail Close Clockwise to Fail Open Counterclockwise configuration or vice versa
- Housing constructed in nodular ductile cast iron; carbon steel or different materials of construction available upon request.
- Carbon steel ENP-lined cylinders; stainless steel cylinders, tie rods and spool pieces available upon request

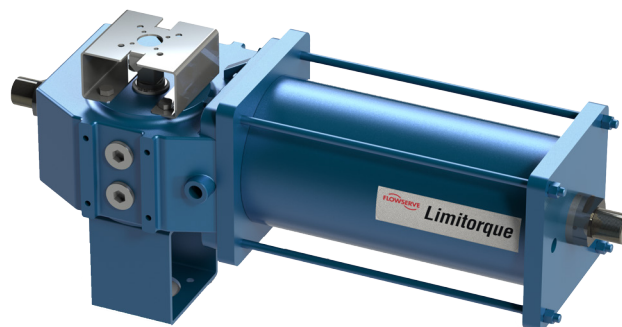

- Suitable for use in on/off, modulating and control valve application in general service, protective service and safety applications such as ESD or HIPPS
- -29°C to 100°C (-20°F to 212°F) standard operating temperature range; Low temperature -60°C (-76°F) and high temperature 160°C (320°F) ranges available upon request (polar, cold, arid and tropical temperature requirements in accordance with IEC 60721)
- End mounted adjustable travel stops $\pm 5^\circ$, available also in an enclosed protected version upon request
- Full range of accessories: switchboxes, positioners; ESD and PST functionalities; custom control panels; fire protection; manual overrides

Model	MOT Maximum Operating Torque Nm (ft-lb)	MOP Maximum Operating Pressure barg (PSIG)	MAWP Maximum Allowable Working Pressure barg (PSIG)
LPC-05	500 (369)	Variable for every model	12 (174)
LPC-10	1600 (1180)		
LPC-12	3500 (2582)		
LPC-14	5500 (4057)		

Limitorque Fluid Power Systems

LHS and LHH Limitorque Hydraulic Scotch Yoke Actuators

The Limitorque Fluid Power family of heavy-duty actuators includes the Limitorque Hydraulic Scotch yoke actuators (LHS and LHH).

Often lighter and more compact than its LPS counterpart, the LHS/LHH offers a choice for those preferring hydraulic motive power. For some, such as those working in an offshore environment, it may be the only practical option in terms of fluid-power availability and performance requirements.

The LHS/LHH Limitorque hydraulic actuators have a robust, modular Scotch yoke design, and are available in both spring-return and double-acting configurations. They are suitable for actuating ball, butterfly and plug valves or any other quarter-turn applications. LHS hydraulic actuators deliver up to 300 kNm (221 270 ft-lb) of precisely controlled controlled torque (contact factory for larger sizes).

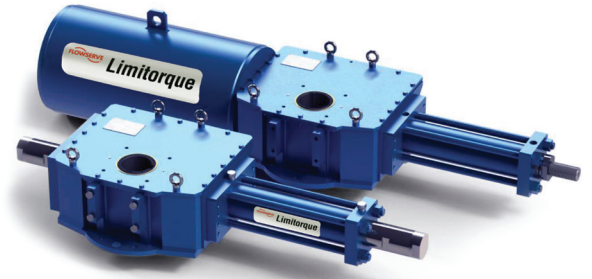

Features and Benefits

- Symmetrical and canted Scotch yoke types to perfectly fit valve torque requirement
- Fabricated carbon steel Scotch yoke housing, hydraulic cylinder and spring can, providing the most rugged actuator available; different materials of construction for polar or offshore applications upon request
- Suitable for use in on/off, modulating and control valve application in general service, protective service and safety applications such as ESD or HIPPS
- -29°C to 100°C (-20°F to 212°F) standard operating temperature range; Low temperature -60°C (-76°F) and high temperature 160°C (320°F) ranges available upon request (polar, cold, arid and tropical temperature requirements in accordance with IEC 60721)
- End mounted adjustable travel stops $\pm 5^\circ$, available also in enclosed protected version upon request

Model	MOT Maximum Operating Torque Nm (ft-lb)	MOP Maximum Operating Pressure barg (PSIG)	MAWP Maximum Allowable Working Pressure barg (PSIG)
LHS/LHH-15	6000 (4425)	Variable for every cylinder size.	LHS: 207 barg (3000 psig) LHH: 345 barg (5000 psig)
LHS/LHH-20	12 000 (8851)		
LHS/LHH-25	21 000 (15 489)		
LHS/LHH-30	40 500 (29 871)		
LHS/LHH-35	75 000 (55 317)		
LHS/LHH-40	150 000 (110 634)		
LHS/LHH-50	300 00 (221 268)		
LHS/LHH-60	Consult Factory	Consult Factory	

* MAWP 410 barg (6000 psig) available upon request

Limitorque Fluid Power Systems

LDG Limitorque Direct Gas actuators

In the demanding world of pipelines, the Limitorque Direct Gas (LDG) is a robust and efficient way of providing reliable pipeline valve automation, even when no external motive power supplies are present. Based on Limitorque's high efficiency scotch-yoke modules, the LDG self-contained system includes both the gas powered actuation unit and the high pressure gas control circuit.

The LDG actuator is available in double acting and spring return configurations and is suitable to be powered by pipeline gas both sweet and sour*, piped directly into the power cylinder through the on-board control system.

LDG controls include both local and remote operation configurations and multiple functionalities to meet application requirements.

*For sour gas applications contact factory

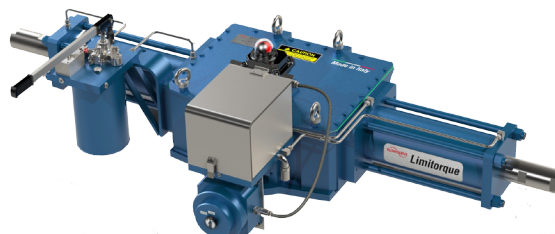

Features and Benefits

- Symmetrical and canted Scotch yoke types to perfectly fit valve torque requirement
- Fabricated carbon steel Scotch yoke housing, high pressure pneumatic cylinder and spring can, providing the most rugged actuator available.
- -29°C to 100°C (-20°F to 212°F) standard operating temperature range; Low temperature -60°C (-76°F) and high temperature 160°C (320°F) ranges available upon request (polar, cold, arid and tropical temperature requirements in accordance with IEC 60721)
- End mounted adjustable travel stops $\pm 5^\circ$, available also in enclosed protected version.
- Electroless Nickel Plated power cylinders guarantee maximum corrosion resistance
- High pressure control circuit eliminates requirement for pressure reduction, improving performance and reducing unit overall dimensions and gas consumption.

Model	MOT Maximum Operating Torque Nm (ft-lb)	MOP Maximum Operating Pressure barg (PSIG)	MAWP Maximum Allowable Working Pressure barg (PSIG)
LDG-15	6000 (4425)	Variable for every cylinder size	105 (1500)
LDG-20	12 000 (8850)		
LDG-25	21 000 (15 489)		
LDG-30	40 500 (29 871)		
LDG-35	75 000 (55 317)		
LDG-40	150 000 (110 634)		
LDG-50	300 000 (221 268)	Consult Factory	
LDG-60	Consult Factory		

LPS, LPC, LHS, LHH, LDG Series Fluid Power Actuators

Key Certifications and Standards Compliance

- Available according to ATEX 94/9/EC Ex II 2GD c IIC T6
- NEMA4 and NEMA4X per NEMA 250
- IP66/IP66M and IP67/IP67M configurations
- Manufactured and tested in compliance with ISO 9001 and EN 15714 Part 3 for pneumatic actuators and Part 4 for hydraulic actuators
- Actuator spring design in compliance with EN 13906
- Available valve interface in compliance with ISO 5211
- Corrosion protection in compliance with ISO 12944-2 and EN 15714; optionally available up to and including C5-M
- Available in compliance with NACE specification MR0175 for sour gas applications
- Available for use in safety integrated systems up to and including SIL Level 3 in accordance with IEC 61508
- Available in compliance with PED 97/23/EC, ASME BPVC Sec. VIII Div. 1, EN 13445-3 Part 2 for Unfired Pressure Vessels
- Available according to CU TR and GOST-R



Control System Options

Limiterque offers a selection of standard and custom controls packages for most applications to meet customers' needs for short-lead time, low cost solutions.

Pneumatic Systems

- PST
- ESD
- Quick-closing
- Modulating/CV functionality
- Quick exhaust valve with flow regulator suitable for closed loop assembly, when required
- Cylinder integral quick exhaust valve for fast-acting actuators
- Pneumatic booster (¼ in, ½ in, 1 in size, AL and 316 SS)
- 3/2 and 5/2 pneumatic piloted valve with manual reset and override (¼ in, ½ in, 1 in size, AL and 316 SS)
- Unidirectional and bidirectional flow regulator valve (¼ in, ½ in, 1 in size, AL and 316 SS)
- Compact fittings to reduce pipe and control dimensions (¼ in, ½ in, 1 in size, AL and 316 SS)

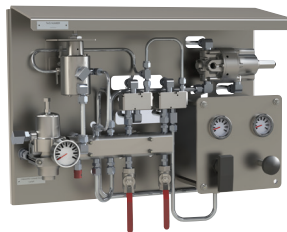

Hydraulic Systems

- Hydraulic control panels
- Hydraulic Power Units (HPU)
- Hydraulic Accumulators Racks
- Self-Contained Units (SCU)
- Electro-Hydraulic Integrated Solutions, upon request



Flowserve Limatorque's determination to make valve control easier is reflected in a comprehensive customer support program.



Global Support for the Latest Valve Control Technology

Support begins before the sale, when customers turn to Flowserve experts for technical assistance in selecting the proper equipment. After the sale, Limatorque customers are backed by 200 factory-trained service technicians. Stationed around the globe, these technicians are available to assist with installation, commissioning and maintenance.

Service

Limatorque customers find their needs met by factories, stocking distributors, parts/service centers and sales offices in more than 100 cities around the world. A network of Flowserve Limatorque Blue Ribbon and global Quick Response Centers with authorized technicians have exclusive access to advanced factory-based engineering resources, repair procedures and information, providing the best in parts and service.

This global Flowserve network ensures that the end user, engineer, contractor or valve manufacturer can access parts and service through a local office.

Technical Support

Internet technology also plays a part in the Limatorque customer service support program. Using the

Flowserve Limatorque website, customers can access key information around the clock, including product specifications and local service contacts. Customers can also use the website for downloading sales and technical literature from the continuously expanding Limatorque library of detailed documentation.

Online documentation (at www.flowserve.com/limatorque) includes sales brochures, specification bulletins, and installation and operation manuals.

Training

Customers can receive individualized hands-on instruction at the Learning Resource Center (the Flowserve national training facility in Dallas, Texas, USA), Flowserve Limatorque's Lynchburg, Virginia, USA headquarters. Training is also offered at Limatorque Houston, Texas, USA, the Limatorque Mezzago, Italy training facilities, and at sales offices located around the world. Training includes proper equipment selection, installation, commissioning, and maintenance of valve actuators and controls.



Flowserve Corporation

United States

Flowserve Limitorque
5114 Woodall Road,
P.O. Box 11318
Lynchburg, VA 24506-1318
Phone: 434-528-4400
Facsimile: 434-845-9736



Italy

Flowserve Limitorque
via Rio Vallone 17
20883 Mezzago (MB), Italy
Phone: +39 039 62060 1
Facsimile: +39 039 62060 213

Singapore

Limitorque Asia, Pte., Ltd.
12, Tuas Avenue 20
Singapore 638824
Phone: 65-6868-4628
Facsimile: 65-6862-4940

China

Limitorque Beijing, Pte., Ltd.
RM A1/A2
22/F, East Area, Hanwei Plaza
No. 7 Guanghua Road, Chaoyang
District
Beijing 100004, Peoples Republic of
China
Phone: 86-10-5921-0606
Facsimile: 86-10-6561-2702

India

Flowserve Limitorque,
Office A, 7th Floor, Plot No 32A & B,
Ambit IT Park, Ambit IT Park Road,
Ambattur Industrial Estate,
Chennai – 600058
Phone: 91-44-2432-8755
& 91-44-2432-4801
Facsimile: 91-44-2432-8754

**To find your local Flowserve Limitorque representative,
visit www.flowserve.com/limitorque or call USA 1 800 225 6989.**



FCD-LMENBR0001-05-A4 Jan 2016 © 2016 Flowserve Corporation

Flowserve Corporation has established industry leadership in the design and manufacture of its products. When properly selected, this Flowserve product is designed to perform its intended function safely during its useful life. However, the purchaser or user of Flowserve products should be aware that Flowserve products might be used in numerous applications under a wide variety of industrial service conditions. Although Flowserve can (and often does) provide general guidelines, it cannot provide specific data and warnings for all possible applications. The purchaser/user must therefore assume the ultimate responsibility for the proper sizing and selection, installation, operation, and maintenance of Flowserve products. The purchaser/user should read and understand the Installation Operation Maintenance (IOM) instructions included with the product, and train its employees and contractors in the safe use of Flowserve products in connection with the specific application.

While the information and specifications contained in this literature are believed to be accurate, they are supplied for informative purposes only and should not be considered certified or as a guarantee of satisfactory results by reliance thereon. Nothing contained herein is to be construed as a warranty or guarantee, express or implied, regarding any matter with respect to this product. Because Flowserve is continually improving and upgrading its product design, the specifications, dimensions and information contained herein are subject to change without notice. Should any question arise concerning these provisions, the purchaser/user should contact Flowserve Corporation at any one of its worldwide operations or offices.

© 2016 Flowserve Corporation, Irving, Texas, USA. Flowserve is a registered trademark of Flowserve Corporation.