



# USER INSTRUCTIONS

## ***D30 Compact Digital Positioner***

*FCD PMENIM0030-01-A5 – 05/18*

**Installation  
Operation  
Maintenance**



# Contents

---

1. Introduction	3
2. Storage	6
3. Installation	7
4. Control	17
5. Maintenance/service	34
6. Trouble shooting	39
7. Technical data	40
8. Dimensions	42
9. Spare parts	43

# 1. Introduction

---

The D30 is a digital positioner designed primarily for controlling modulating valves. The positioner can be used with single or double acting actuators with either rotary or linear movement.

The D30 can be equipped with modules for limit switches and pressure gauges. Pressure sensors can be installed to offer advanced diagnostics.

The modules can be factory assembled before delivery or fitted later.

The modules for limit switches can contain one of the following:

- Two mechanical contacts
- Two proximity switches
- Two inductive sensors

See [page 12](#) for more options available

**Warning!***Special Conditions for Safe Use*

The enclosure of PMV D30 Intrinsically safe version is made of aluminium and any impact or friction caused by external objects shall be avoided in the application.

The surface area of the plastic parts on the cover exceeds the limits specified in EN 60079-0 for II 1G (EPL Ga) for gas group IIC and intensive rubbing or brush charging should be avoided when used in an IIC explosive atmosphere.

The cable connection of the Remote Unit with the D30 – unit shall be type A or B in accordance with EN 60079-25. The cable must be adequately mechanically protected in all instances and have a temperature rating for the ambient temperature range at the site.

Control Drawing D4-086C contains the parameters for intrinsically safety.

The intrinsic safe circuits D30 is insulated from earth and complies with the dielectric strength test of 500 VAC.

In a hazardous environment where there is a risk of explosion, electrical connections must comply with the relevant regulations.

Do not disconnect equipment unless area is known to be non-hazardous. or; read, understand and adhere to the manufacturer's live maintenance procedures. To prevent ignition of flammable or combustible atmospheres, disconnect power before servicing,

Substitutions of components may impair suitability for hazardous (classified) locations.

When installing PMV D30 Intrinsically safe unit always consult drawing D4-086C



## Maintenance Service

### Warning!

When upgrading electronically parts inside a PMV positioner approved for installation in Hazardous locations special procedures apply, permission from PMV/Flowserve is required prior to the start of work. Please contact a Flowserve office for information regarding proper procedures [www.pmv.nu](http://www.pmv.nu) or [infomv@flowserve.com](mailto:infomv@flowserve.com)

-Always turn off the air and electrical supplies before starting any work.

### Safety instruction

Read the safety instructions in this manual carefully before using the product. The installation, operation, and maintenance of the product must be done by staff with the necessary training and experience. If any questions arise during installation, contact the supplier/sales office before continuing work.

### Warning

The valve can open or close very quickly when in operation and, if handled incorrectly, it may cause damages. There may also be unintentional effects due to it fully opening or shutting off the flow in the process pipe. Please note the following:

- If the input signal fails or is switched off, the valve operates quickly to its default position.
- If the compressed air supply fails or is turned off, rapid movements can occur.
- The valve is not controlled by the input signals when in the Out of Service mode. It will open/close in the event of an internal or external leak.
- If a high value is set for Cut off, fast movements can occur.
- When the valve is controlled in the Manual mode, the valve can operate quickly.
- Incorrect settings can cause self-oscillation, which can lead to damage.

### Important

- Always turn off the compressed air supply before removing or disconnecting the air supply connection or the integral filter. Remove or disconnect with care as air connection "C-" is still under pressure even after the air supply is turned off.
- Always work in an ESD (Emergency Discharge) protected area when servicing the Printed circuit boards (PCB's). Make sure the input signal is switched off.
- The air supply must be free from moisture, water, oil and particles according to DIN/ISO 8573-1-2001 3.2.3.

## 2. Storage

---

### General

The D30 positioner is a precision instrument. Therefore it is essential that it is handled and stored in the correct way. Always follow the instructions in this IOM!

**Note:** As soon as the positioner is connected and started, internal air venting will provide protection against corrosion and prevent the ingress of moisture. For this reason, the air supply pressure should always be kept on unless repair/maintenance work of the positioner, actuator or valve equipment is in progress.

Keep the cover mounted on the positioner and replace any damaged window.

### Storage indoors

Store the positioner in its original packaging. The storage environment must be clean, dry, and cool (15 to 26°C, 59 to 79°F).

### Storage outdoors or for a longer period

If the positioner must be stored outdoors, it is important that all the cover screws are tightened and that all open ports/connections are properly sealed and/or plugged.

The red shipping plugs are not intended as a permanent outdoor plug. The unit should be packed with a desiccant (silica gel) in a plastic bag or similar, covered with plastic, and not exposed to sunlight, rain, or snow.

This is also applicable for long-term storage (more than 1 month) and for long transport by sea.

### Storage in a warm place

When the positioner is stored - without air supply pressure applied - in a warm place with a high relative humidity and is subjected to daily temperature variations, the air inside the unit will expand and contract.

This means that air from outside the unit may be drawn into the positioner. Depending on the temperature variations, relative humidity, and other factors, condensation and corrosion can occur inside the unit, which in turn can give rise to functional disorders or a failure.

### 3. Installation

#### Removal of cover

##### General purpose / Intrinsically safe

Remove cover by first loosening the screw **1** and then the two screws **2**.

To install cover, first tighten the screw **1**, then the two screws **2**.

Tighten to 1.5 Nm ± 15%.

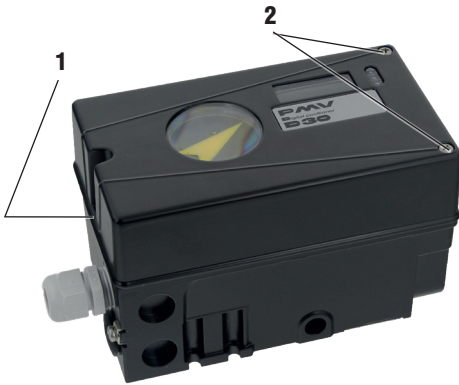

Supply air should meet requirements specified on [page 5](#). A coalescing filter/regulator should be installed in front of the supply air connection. Now connect the air supply to the filter, which is connected to the D30 positioner.

#### Tubing

It is recommended to use tubes with a minimum inner diameter of Ø 6 mm (¼”).

#### Air supply requirements

##### Poor quality air supply is the main cause of problems in pneumatic systems.

The air supply must be free from moisture, water, oil and particles and delivered @ 1.4-8 barg (20-115 psi)

##### Standard: **DIN/ISO 8573-1-2001 3.2.3**

Filtered to 5 Micron, dew point -40°C/F

Oil 1mg/m<sup>3</sup> (0,83 ppm by weight)

The air must come from a refrigeration dried supply or be treated in such a way that its dew point is at least 10°C (18°F) below the lowest expected ambient temperature.

To ensure a stable and problem-free air supply, we recommend the installation of a coalescing filter/regulator <5µ as close to the positioner as possible.

Before the air supply is connected to the positioner, we recommend the hose is opened freely for 2 to 3 minutes to allow any contamination to be blown out. Direct the air jet into a large paper bag to trap any water, oil, or other foreign materials. If this indicates that the air system is contaminated, it should be properly cleaned before continuing.



**WARNING!** Do not direct the open air jet towards people or objects because it may cause personal injury or damage.

**Mounting**

**Note:** If the positioner is installed in a hazardous environment, it must be of a type approved for this purpose.

All versions of the D30 positioner have an ISO F05 footprint. The holes are used to attach the D30 to the mounting bracket B. Please contact PMV or your local distributor representative with actuator specifics for the proper mounting bracket and hardware.

The spindle shaft S09 can be changed to suit various actuators in question by the use of adaptors.

It is important that the positioner’s spindle shaft and the lever arms, that transfer the actuator movements, are correctly mounted. Any tension between these parts can cause incorrect operation and abnormal wear.

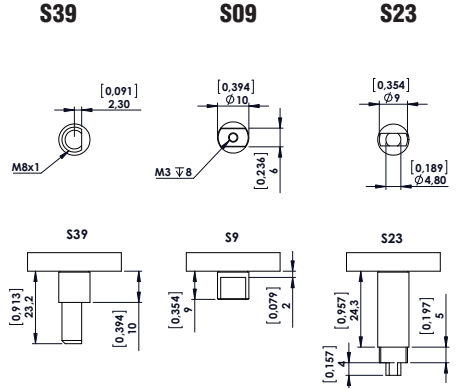

**Note:** There are many spindle options available depending on the actuator. Please contact your local PMV supplier for all options available.

**Spindle shafts**

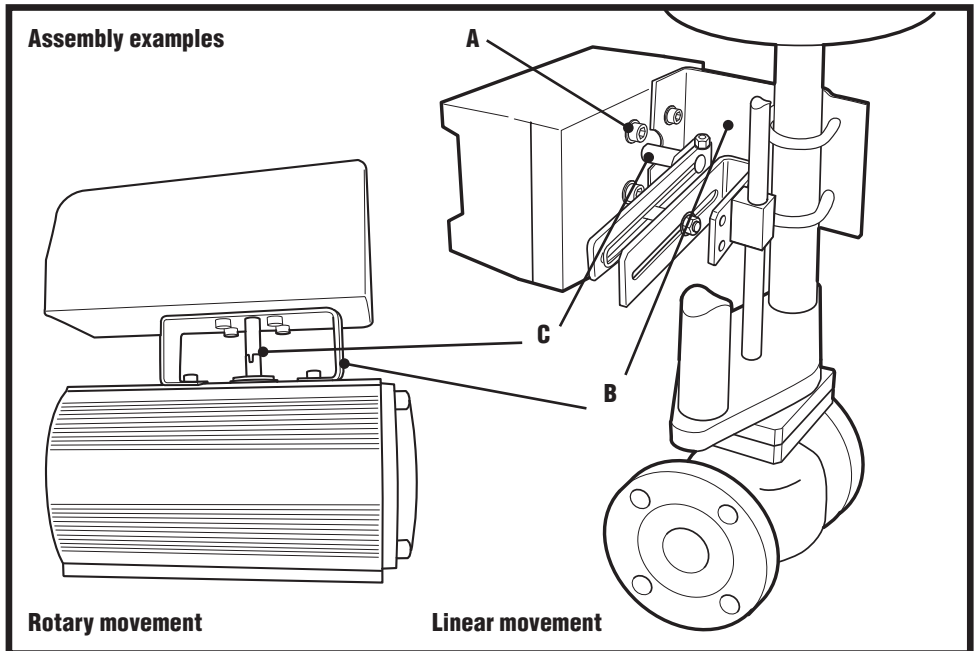



**Connections**

**Air:**

- Port S Supply air, 1.4-8 barg (20-115 psi)
- Port C+ Connection to actuator, opening
- Port C- Connection to actuator, closing (only for double action)  
Plug for single action, see below

**Dimensions**

Air connections: 1/4" NPT alt. G 1/4"

Electrical connection: M20 x 1.5 alt. NPT 1/2"

Loctite 577 or equivalent is recommended as a sealant.

**Electrical connection**

See [page 12](#).

**Must be plugged when converting to single action function.**

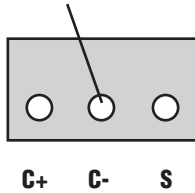

**External air Connection**

**Rotary actuators VDI/VDE 3485 (Namur)**

Fit bracket on actuator and secure with 4 x screws.

Mount positioner to bracket. Secure with 4 x M6 screws using 2.5 Nm (1.8 lb ft) torque.

Install tubing between actuator and positioner.

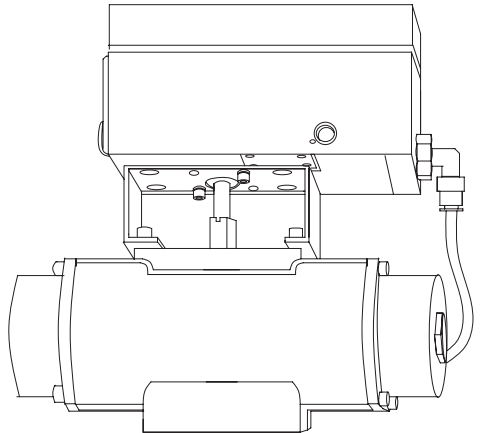

**Single acting positioner, Direct function  
Actuator with closing spring**

When the control signal increases, the pressure C+ to the actuator is **increased**. The valve stem moves upward and rotates the positioner spindle **counter-clockwise**. When the control signal drops to zero, C+ is vented and the valve closes.

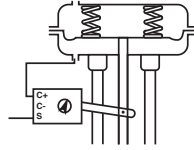

**Reverse function**

**Actuator with opening spring**

When the control signal increases the pressure C+ to the actuator is **increased**. The valve stem moves downward and the positioner spindle rotates **clockwise**. When the control signal drops to zero, C+ is vented and the valve opens.

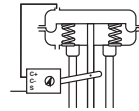

**Double acting positioner, Direct function**

**Double acting actuator**

When the control signal increases, the pressure C+ to the actuator is increased. The valve stem is pressed upward and rotates the positioner spindle counter-clockwise. When the control signal is reduced, the pressure C- to the actuator increases and the valve spindle is pressed downward. If the control signal disappears, the pressure goes to C-, C+ vents, and the valve closes.

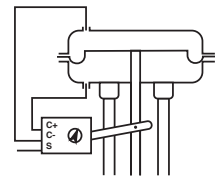

**Gauge block**

Gauge blocks are available for D30s with 1/4" G or 1/4" NPT air connections. To install, ensure seals are aligned, then use 3 Nm (2.2 lb ft) of torque when fastening the gauge block to the positioner using the two screws supplied with the kit.



**Electrical connections**

Terminal block diagram for the D30.

The terminal block for the positioner is accessible when the aluminum cover is removed.

The D30 digital positioner has been designed to operate correctly in electromagnetic (EM) fields found in typical industrial environments. Care should be taken to prevent the positioner from being used in environments with excessively high EM field strengths (greater than 10 V/m). Portable EM devices such as hand-held two-way radios should not be used within 30 cm of the device.

Ensure proper wiring and shielding techniques of the control lines, and route control lines away from electro-magnetic sources that may cause unwanted noise.

An electromagnetic line filter can be used to further eliminate noise.

In the event of a severe electrostatic discharge near the positioner, the device should be inspected to ensure correct operability. It may be necessary to recalibrate the D30 positioner to restore operation.

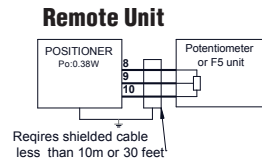
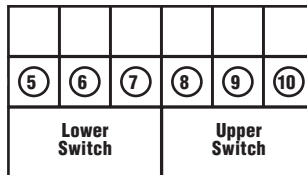
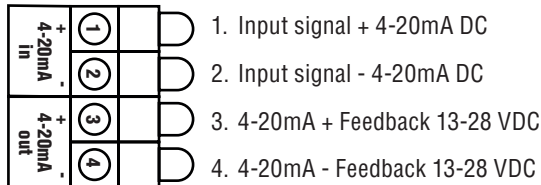

Order code	Switch	5	6	7	8	9	10
S	Limit switches Mechanical SPDT	NO	NC	Com	NO	NC	Com
N	Namur V3 type sensor, P&F NJ2-V3-N	-	+	Not Used	-	+	Not Used
P	Limit switches Proximity SPDT	NO	NC	Com	NO	NC	Com
5	Slot type Namur sensor, P&F SJ2-SN	-	+	Not Used	-	+	Not Used
6	Slot type Namur sensor, P&F SJ2-N	-	+	Not Used	-	+	Not Used
RM	Remote Board	Not Used	Not Used	Not Used	CCW	RA	CW

**Warning!** In a hazardous environment where there is a risk of explosion, electrical connections must comply with the relevant regulations.

**Limit switch calibration**

- Losen screws (1) and adjust cams.
- Adjust lower cam first and then upper cam
- Tighten screws (1)

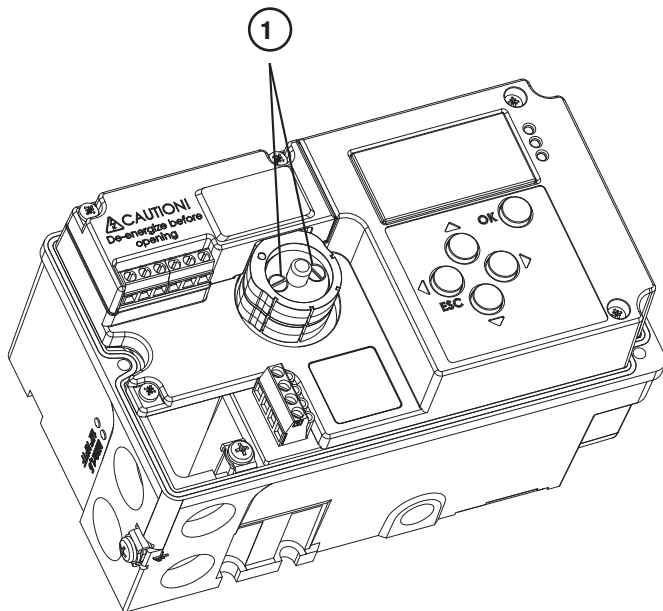

## Feedback option (cont.) Calibration of the 4-20 mA transmitter

Go to menu shown in diagram.  
Connect mA meter I and check reading.  
Adjust output signal using Up or Down key  
until meter I reads 4.00 mA.  
Finish by pressing OK.  
Repeat the above for 20 mA.

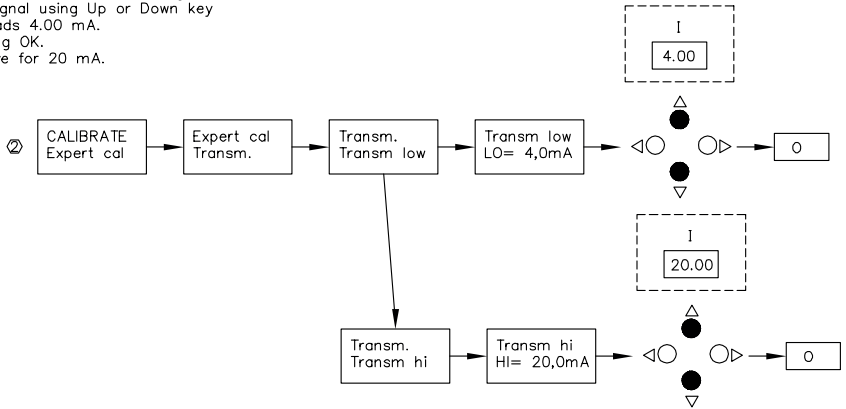

## Connecting switches/input signal/output signal

model code position K										model code position B						A	E
	Note	SWITCH	Type	Cl rF	U/LH	U/V	I r mA	Fl mW	Max. temp	14 (°)	15 (°)	16 (°)	ATEX Da	IECEx Ia			
5	2	SJ2-SN	NAMUR	30	100	14	25	34	-40	94	68	56	100	Ga, Da	Ga, Da		
6	1	SJ2-N	NAMUR	30	100	14	25	34	-25	94	68	56	100	Ga, Da	Ga, Da		
7	1	SC2-ND-GN	NAMUR	150	150	14	25	34	-25	95	67	55	100	Ga, Da	Ga, Da		
8	1	SC2-ND-YE	NAMUR	150	150	14	25	34	-25	95	67	55	100	Ga, Da	Ga, Da		
G		Mechanical switch gold	Mec.	1	1	28	45	315	-40	78	60	45		Ga, Da	Ga, Da		
N	3	SJ2-V-SN	NAMUR	30	100	14	25	34	-25	94	68	56	100	Ga	Ga		
P		Proxim Proximity	Reed	1	1	28	45	315	-40	85	-	-		Ga, Da	Ga, Da		
S		Mechanical switch	Mec.	1	1	28	45	315	-40	78	60	45		Ga, Da	Ga, Da		
V	3	NCN4-V3-ND	NAMUR	100	100	14	25	34	-25	73	88	100	100	Ga	Ga		

note 1 Higher U.LI and PI with lower ambient temperatures are allowed see Certificate PB 99 ATEX 2219 X or IECEx PB 11.0091X  
note 2 Higher U.LI and PI with lower ambient temperatures are allowed see Certificate PB 00 ATEX 2049 X or IECEx PB 11.0092X  
note 3 Higher U.LI and PI with lower ambient temperatures are allowed see Certificate PB 00 ATEX 2032 X or IECEx PB 11.0021X

### 4-20mA input signal Pin 1 and 2

(Position B; B=A or B=E) AND  
(Position J; J=4 or J=5)

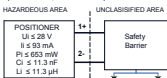

### 4-20mA Output signal Pin 3 and 4

(Position B; B=A or B=E) AND  
(Position J; J=4 or J=5) AND  
(Position K; K≠X)

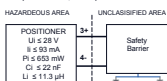

### Type sign example

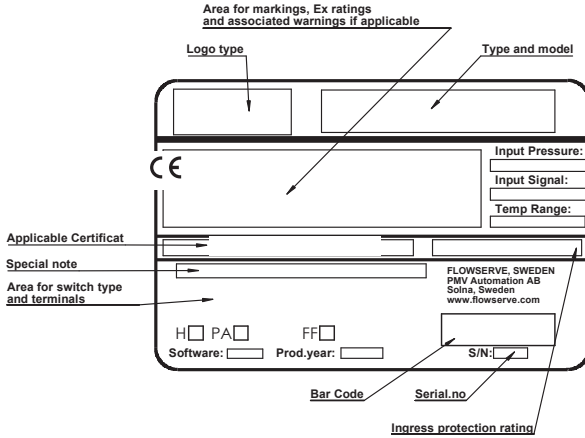

REVISIONS				
REV.	DESCRIPTION	DATE	APPROVED	

Area for logotype  
Område för logotyp

Type and model  
Typbeteckning och modellkod

<p><b>Certification declaration</b></p> <p><b>INTRINSICALLY SAFE</b> Data: Where installed in accordance with installation wiring as per IEC.</p> <p><b>WARNING!</b> Avoid intensive rubbing or brush charging of plastic parts in IEC explosive atmosphere.</p> <p><b>Presafe 17 ATEX 11142X IP 66</b></p>	<p><b>Input Pressure:</b></p> <p><b>Input Signal:</b></p> <p><b>Temp Range:</b></p>
---	---

FLOWERVE, SWEDEN  
PMV Automation AB  
SoIna, Sweden  
www.flowerve.com

H  PA  FF

Software:  Prod.year:

S/N:

Bar Code  
Serial.no  
NEMA Type  
Ingress protection rating

Model code	Certification declaration
D0Axxxx-xxxxxD-xxxxxx or D0Bxxxx-xxxxxD-xxxxxx or where y/n/i or y/n/i	II 1G Ex ia IIC T4 Ta -40°C to 85°C Ga II 1D Ex ia IIC T80°C Da
D0Axxxx-xxxxxD-xxxxxx or D0Bxxxx-xxxxxD-xxxxxx or where y/n/i or y/n/i	II 1G Ex ia IIC T4 Ta -40°C to 85°C Ga

Model code	Certification declaration
D0Axxxx-xxxxxD-xxxxxx or D0Bxxxx-xxxxxD-xxxxxx or where y/n/i or y/n/i	II 1G Ex ia IIC T4 Ta -40°C to 85°C Ga

D30 Model code

1 2 3 4 5 6 7 8 9 10 11 12 13 14 15 16 17 18 19  
A A A B C D E F G G H H H - 1 J K L M N

Schedule drawing  
Schedulad ritning

DESCRIPTION	MATERIAL	QUANTITY	UNIT	PROVISION
SOLE NO.	UNIMPROVED TOLERANCES ACCORDING TO ISO 2768	PRODUCTION DIMENSIONS	SCHEMATIC	Scheduled Drawing

FLOWERVE	PMV Positioner D30	REV OF: 0	SCALE: 2:1	DATE: 2017-11-08
PMV Automation AB KORTA GÅTAN 9 SE-171 84 SOLNA SWEDEN - Tel: +46(0)8 555 100 00 - www.pmv.se	D4-090C-A			

REVISIONS				
REV.	DESCRIPTION	DATE	APPROVED	

Area for logotype  
Område för logotyp

Type and model  
Typbeteckning och modellkod

<p><b>Certification declaration</b></p> <p><b>INTRINSICALLY SAFE</b> Data: Where installed in accordance with installation wiring as per IEC.</p> <p><b>WARNING!</b> Avoid intensive rubbing or brush charging of plastic parts in IEC explosive atmosphere.</p> <p><b>IECEx PRE 17.0046X IP 66</b></p>	<p><b>Input Pressure:</b></p> <p><b>Input Signal:</b></p> <p><b>Temp Range:</b></p>
---	---

FLOWERVE, SWEDEN  
PMV Automation AB  
SoIna, Sweden  
www.flowerve.com

H  PA  FF

Software:  Prod.year:

S/N:

Bar Code  
Serial.no  
NEMA Type  
Ingress protection rating

Model code	Certification declaration
D0Axxxx-xxxxxD-xxxxxx or D0Bxxxx-xxxxxD-xxxxxx or where y/n/i or y/n/i	II 1G Ex ia IIC T4 Ta -40°C to 85°C Ga II 1D Ex ia IIC T80°C Da
D0Axxxx-xxxxxD-xxxxxx or D0Bxxxx-xxxxxD-xxxxxx or where y/n/i or y/n/i	II 1G Ex ia IIC T4 Ta -40°C to 85°C Ga

Model code	Certification declaration
D0Axxxx-xxxxxD-xxxxxx or D0Bxxxx-xxxxxD-xxxxxx or where y/n/i or y/n/i	II 1G Ex ia IIC T4 Ta -40°C to 85°C Ga

D30 Model code

1 2 3 4 5 6 7 8 9 10 11 12 13 14 15 16 17 18 19  
A A A B C D E F G G H H H - 1 J K L M N

Schedule drawing  
Schedulad ritning

DESCRIPTION	MATERIAL	QUANTITY	UNIT	PROVISION
SOLE NO.	UNIMPROVED TOLERANCES ACCORDING TO ISO 2768	PRODUCTION DIMENSIONS	SCHEMATIC	Scheduled Drawing

FLOWERVE	PMV Positioner D30	REV OF: 0	SCALE: 2:1	DATE: 2017-11-08
PMV Automation AB KORTA GÅTAN 9 SE-171 84 SOLNA SWEDEN - Tel: +46(0)8 555 100 00 - www.pmv.se	D4-090C-E			

## D30 Digital Positioner model code

<b>A</b>	<b>Model no</b>		<input type="checkbox"/>
	D 3 0	Full LCD menu, LED status	
<b>B</b>	<b>Approval, Certificate</b>		<input type="checkbox"/>
	D	General purpose version	<input type="checkbox"/>
	E	IEC	<input type="checkbox"/>
	A	ATEX	<input type="checkbox"/>
<b>C</b>	<b>Function</b>		<input type="checkbox"/>
	H	High Flow - Single/double acting - Spool valve	<input type="checkbox"/>
<b>D</b>	<b>Connections Air, Electrical</b>		<input type="checkbox"/>
	G	1/4" G air, M20 x 1,5 electrical	<input type="checkbox"/>
	M	1/4" NPT air, M20x1,5 electrical	<input type="checkbox"/>
	N	1/4" NPT air, 1/2"NPT electrical	<input type="checkbox"/>
<b>E</b>	<b>Connection feature</b>		<input type="checkbox"/>
	2	2 Electrical conduits	<input type="checkbox"/>
	T	2 Electrical conduits, threaded Aux. ventilation	<input type="checkbox"/>
<b>F</b>	<b>Housing material/Surface treatment</b>		<input type="checkbox"/>
	U	Aluminium/Powder epoxy, black	<input type="checkbox"/>
<b>G</b>	<b>Mounting options / Shaft</b>		<input type="checkbox"/>
	R M	Remote mounting (position sensing unit sold separately)	<input type="checkbox"/>
	0 9	Double D type, adaptor spindle	<input type="checkbox"/>
	2 1	NAF shaft, including Mounting bracket D4-As920	<input type="checkbox"/>
	2 3	VDI/VEDE 3845 rotary, Mounting kit not included	<input type="checkbox"/>
	3 0	Adaptor shaft, select between 01/06/26/30/36	<input type="checkbox"/>
	3 9	IEC 534-6, Flat D type, nut incl. Mounting kit not included	<input type="checkbox"/>
<b>H</b>	<b>Cover and Indicator</b>		<input type="checkbox"/>
	P V A	PMV, Black cover, Arrow indicator	<input type="checkbox"/>
	P V B	PMV, Black cover, No indicator	<input type="checkbox"/>
	F W A	Flowserve, White, Arrow indicator	<input type="checkbox"/>
	F W B	Flowserve, White, No indicator	<input type="checkbox"/>
<b>I</b>	<b>Temperature/seals</b>		<input type="checkbox"/>
	U	-40°C to 80°C	<input type="checkbox"/>
<b>J</b>	<b>Input signal/Protocoll</b>		<input type="checkbox"/>
	4	4-20 mA / none	<input type="checkbox"/>
	5	4-20 mA, / HART	<input type="checkbox"/>
	P	Profibus PA (Only when B = D)	<input type="checkbox"/>
<b>K</b>	<b>Feedback option, switches</b>		<input type="checkbox"/>
	X	No feedback option	<input type="checkbox"/>
	T	4-20 mA transmitter only	<input type="checkbox"/>
	S	Limit switches Mechanical SPDT	<input type="checkbox"/>
	N	Namur V3 type sensor, P+F NJ2-V3-N	<input type="checkbox"/>
	P	Limit switches Proximity SPDT	<input type="checkbox"/>
	5	Slot type Namur sensor, P+F SJ2-SN	<input type="checkbox"/>
	6	Slot type Namur sensor, P+F SJ2-N	<input type="checkbox"/>
<b>L</b>	<b>Options, Add in electronics</b>		<input type="checkbox"/>
	0	No pressure sensors	<input type="checkbox"/>
	3	3 pressure sensors	<input type="checkbox"/>
<b>M</b>	<b>Accessories</b>		<input type="checkbox"/>
	X	No accessories	<input type="checkbox"/>
	M	Gauge block 1/4" G (DA, 3 gauges included)	<input type="checkbox"/>
	N	Gauge block 1/4" NPT (DA, 3 gauges included)	<input type="checkbox"/>
<b>N</b>	<b>Special Options</b>		<input type="checkbox"/>
	N	No special options	<input type="checkbox"/>
	S	Exhaust silencers	<input type="checkbox"/>

A	A	A	B	C	D	E	-	F	G	G	H	H	H	-	I	J	K	L	M	N
---	---	---	---	---	---	---	---	---	---	---	---	---	---	---	---	---	---	---	---	---



## 4. Control

### Menus and pushbuttons

The positioner is controlled using the five pushbuttons and the display, which are accessible when the aluminum cover is removed.

For normal functioning, the display shows the current value. Press the ESC button for two seconds to display the main menu.

Use the pushbuttons  to browse through the main menu and the sub-menus.

The main menu is divided up into a basic menu and a full menu, see [page 19](#).

### Other functions

#### ESC

Exit the menu without making any changes (as long as any changes have not been confirmed with OK).

#### FUNC

To select function and change parameters.

#### OK

To confirm selection or change of parameters.

### MENU INDICATOR

Displays the position of the current menu row in the menu.

### IN SERVICE

The positioner is following the input signal. This is the normal status when the positioner is working.

### OUT OF SERVICE

The positioner is not following the input signal. Critical parameters can be changed.

### MANUAL

The positioner can be stroked manually using the pushbuttons. See section “Man/Auto”, [page 25](#).

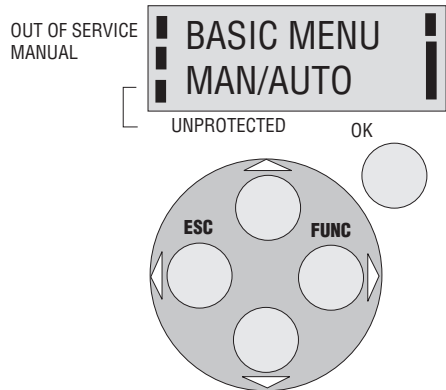

### UNPROTECTED

Most of the parameters can be changed when the positioner is in the “Unprotected” position. However, critical parameters are locked when the positioner is in the “In service” position.

LED color (R=Red, Y=Yellow, G=Green)

Codes during In Service			
	R		Actual valve position deviates from requested/set position
	Y		Fully opened/closed valve using Cut Off (= OK)
	G		Controlling valve position (= OK)

Codes during Out of service			
	R	Y	Input signal not calibrated
	Y	G	Feedback signal not calibrated
	Y	Y	Out of Service (= OK)

Calibration alarm			
	R	G	No feedback movement. Check linkage from actuator to positioner
	R	Y	No air available. *(alarm available only when pressure sensors installed)
R	G	G	No pot connection. Check pot cable inside positioner.
R	Y	Y	No air relay. Check cable inside positioner.
R	Y	G	Pot not calibrated. Go to Calibrate->Expert->Pot on LCD menu.

### Menu indicator

There are indicators at both sides of the display window and they indicate as follows:

Flashing in position **Out of service**

Flashing in position **Manual**

Displayed in position **Unprotected**

The indicators on the right-hand side show the position in the current menu.

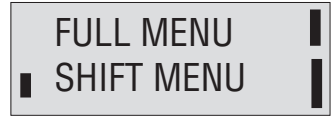
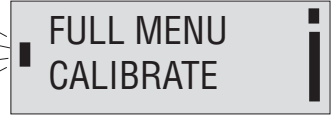

### Menus

To display the menus you can select:

- **Basic menu**, which means you can browse through four different menu items

- **Full menu**, which comprises ten steps. Use the Shift Menu to browse through the menu items

Full Menu can be locked out using a passcode.

The main menus are shown on the next page and the sub-menus on the subsequent pages.

### Changing parameter values

Change by pressing   until the desired figure is flashing.

Press  to step to the desired figure. Confirm by pressing OK.

A change can be undone by pressing the **ESC** button, which returns you to the previous menu.

## Menu system

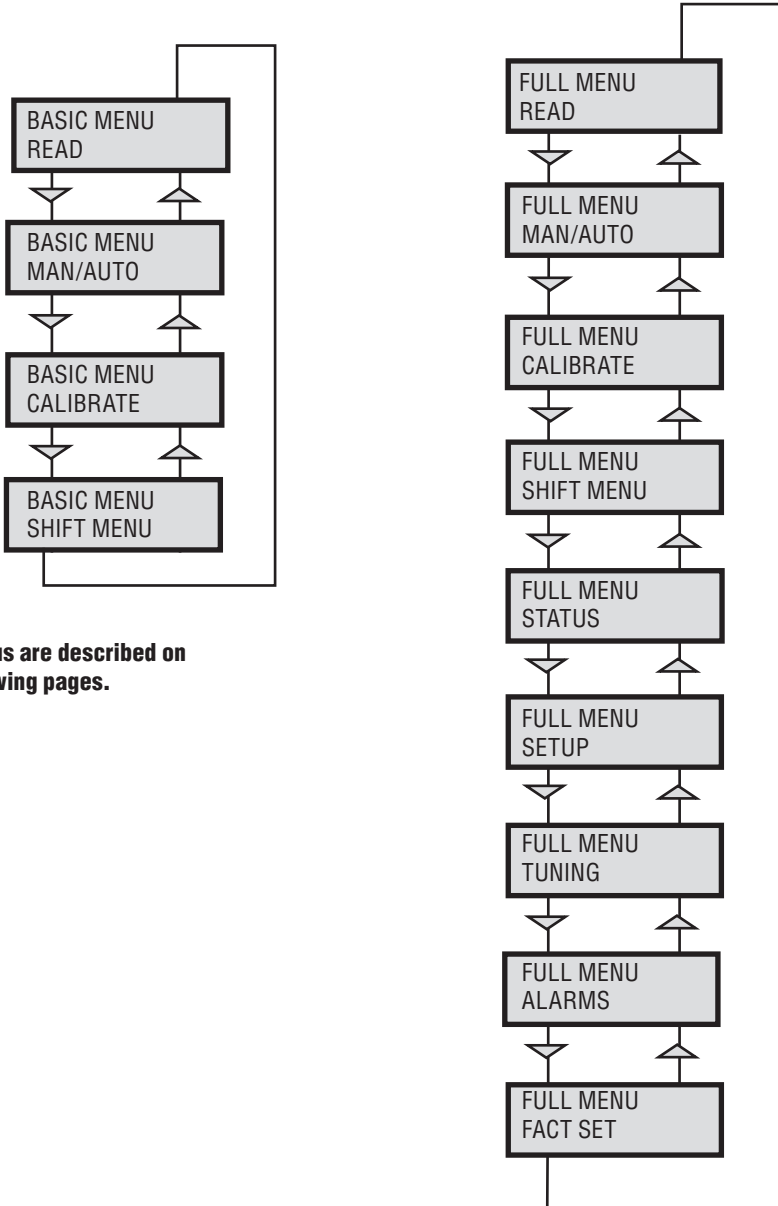

The menus are described on the following pages.

**BASIC MENU  
CALIBRATE** →

**First start**

“Calibrate” is displayed in the basic menu automatically, the first time power is applied. It can be selected from the basic or full menu at any time.

A complete auto-calibration will take a few minutes depending on size of actuator and includes end limit calibration (zero and span), auto-tuning (dynamically sets the control parameters for the actuated package the positioner is controlling) and a check of the movement speed. Start the automatic calibration by selecting **Auto-Cal** and then answer the questions in the display by pressing **OK** or the respective arrow. More detail about these questions can be found on [page 23](#).

**Calibration error messages**

If a fault occurs during calibration, one of the following error messages can be displayed:

**No movement/press ESC to abort**

Typically the result of an air delivery issue to the actuator, a stuck valve or actuator, or incorrect mounting and/or linkage arrangement. Check for proper supply air to the positioner, pinched tubing, proper actuator sizing, proper linkage and mounting arrangement.

**Pot uncalibrated/press ESC to abort**

The potentiometer is out of range. The potentiometer is aligned using the Calibrate - Expert cal - pot Menu. The calibration sequence must be restarted after the fault is corrected.

**Tip! Instant quick calibration**

The D30 can be instantly calibrated by pressing the top + bottom buttons for 5 seconds (see picture). This function is available from any menu position.

**First start, Profibus PA**

For Profibus PA, connect the input signal at pos 1 and 2 on the terminal block. See Electrical connections in the manual.

In the SETUP/Devicedata/Profibus: change the address from 126 to any number between 1-125. Never use the same number with more than one unit. Install values in failsafe mode, for communication when loss of signal. Calibrate the unit. GSD files are available at our web-page [www.pmv.nu](http://www.pmv.nu)

**To install the D30\_PROFIBUS.DDL file to Siemens SIMATIC PDM.**

1. Move the files to the directory where the DeviceInstall.exe is located.
2. Run DeviceInstall.exe

**For Expert Calibration parameters - see [page 29!](#)**

**For further information on calibrating the pot - see [page 38](#)**



**Instant quick calibration**

<b>Parameter</b>	<b>Description</b>		<b>BYTE</b>
SP	Setpoint	The SP has 5 bytes, 4 bytes for the float value and one status byte. The status byte needs to be 128 (0x80Hex) or higher for the D30 to accept it.	4+1=5
READBACK	Position	The READBACK has 5 bytes, 4 bytes for the float value and one status byte.	4+1=5
POS_D	Digital position	Returns actual position as a digital value with definitions as below 0 = Not initialized 1 = Closed 2 = Opened 3 = Intermediate	2
CHECKBACK		Detailed information of the device, coded bit wise. Several messages can occur at the same time.	3
RCAS_IN	Remote Cascade	The RCAS_IN has 5 bytes, 4 bytes for the float value and one status byte.	4+1=5
RCAS_OUT	Remote Cascade	The RCAS_OUT has 5 bytes, 4 bytes for the float value and one status byte.	4+1=5

### Status Byte Table

<b>MSB</b>							<b>LSB</b>	<b>Meaning</b>	<b>D30 info</b>
0	0	0	0	1	0	x	x	Not connected	
0	0	0	0	1	1	x	x	Device failure	PROFibus PA module failure
0	0	0	1	0	0	x	x	Sensor failure	No sensor value
0	0	0	1	1	1	x	x	Out of service	AI Function Block in O/S mode
1	0	0	0	0	0	x	x	Good - Non cascade	Measured value OK All Alarm values used
1	0	0	0	0	0	0	0	OK	
1	0	0	0	1	0	0	1	Below low limit Lo	Advisory alarm
1	0	0	0	1	0	1	1	Above high limit Hi	Advisory alarm
1	0	0	0	1	1	0	1	Lo-Lo	Critical alarm
1	0	0	0	1	1	1	1	Hi-Hi	Critical alarm

Example SP = 43.7% and 50%

<b>Float</b>	<b>Hex</b>	<b>Status</b>
43.7	42 2E CC CD	80
50.0	42 48 00 00	80

**(FF) Foundation Fieldbus function blocks**

Function blocks are sets of data sorted by function and use. They can be connected to each other to solve a control process, or to a controlling DCS. To get a good introduction and understanding of FF look at [www.fieldbus.org](http://www.fieldbus.org) and download the “Technical Overview” from the About FF pages.

**(TB) Transducer Block**

The TB contains unit specific data. Most of the parameters are the same as parameters found on the display. The data and the order of data varies between different products. The AO-block setpoint (SP) and process value (PV) parameters are tranceived to the TB through a channel. The TB has to be in AUTO for the AO-block to be in AUTO.

The positioner has to be in menu-auto mode and in service to be controlled from the fieldbus. If the positioner is placed in menu-manual mode then the transducer block will be forced to (LO) local override. In this way a person in the field will be able to control the positioner from the keypad, without collision with a control loop.

**(RB) Resource Block**

The RB is a set of parameters that looks the same for all units and products. The values of the RB define unit information that concerns the Fieldbus Protocol such as MANUFAC\_ID which informs the unique manufacturer id. For Flowserve it is 0x464C53. The RB has to be in AUTO for the AO-block to be in AUTO.

**(AO) Analogue Output Block**

The AO follows Fieldbus Foundation’s standard on content and action. It is used for transferring (SP) setpoints from the bus to the positioner.

CAS\_IN (cascade input) and RCAS\_IN (remote cascade input) are selected as inputs to the AO block depending on the MODE\_BLK parameter. The selected input will be relayed to the SP parameter of the AO block. BKCAL\_OUT

AO-block overview

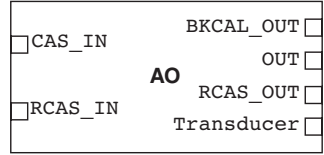

(back calculated output) is a calculated output that can be sent back to a controlling object so that control bumps can be avoided. Usually the BKCAL\_OUT is set to be the (PV) process value of the AO-block, i.e. the actual measured position of the valve. OUT is the primary calculated output of the AO block. During a limited action (ramping) of the AO block the RCAS\_OUT parameter will supply the final setpoint and the OUT parameter will be the limited output. The transducer block is connected through a channel to the AO block. Through this channel the OUT value and SP are tranceived.

In order to set the AO block to AUTO, the TB and the RB have to be in AUTO. Further the AO block has to be scheduled. Using National Instruments Configurator; scheduling can be done by adding the unit to a project and then click on the “upload to device” icon.

To write a setpoint value by hand, add Man to MODE->Permitted parameter, and then choose MODE->Target to Man. Make sure that the unit is scheduled.

**Example**

A typical FF block loop control might look like the following: Where the positioner is represented by the AO-block.

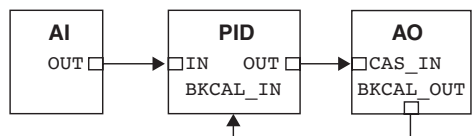



The contents of the menu are shown on the next page. The various menu texts are described below.

**Auto-Cal**

Auto-tuning and calibration of end positions

**Start tune**

Starts the tuning. Questions/commands are displayed during calibration. Select the type of movement, function, etc. with  and confirm with OK as shown in the chart on the next page.

**Lose prev value? OK?**

A warning that the value set previously will be lost (not during the first auto-tuning).

**Direction? Air-to-open.**

Select for direct function.

**Direction? Air-to-close.**

Select for reverse function.

**In service? Press OK**

Calibration finished. Press OK to start positioner functioning. (If ESC is pressed, the positioner assumes the "Out of service" position but the calibration is retained).

**TravelCal**

Calibration of end positions

**Start cal**

Start end position calibration.

**Lose prev value? OK?**

A warning that the previously set value will be lost. Confirm with OK. The calibration sequence starts.

**In service? Press OK**

Calibration finished. Press OK to start positioner functioning. (If ESC is pressed, the positioner assumes the "Out of service" position but the calibration is retained).

**Perform**

Setting gain

**Normal**

100% gain

**Perform G, F, E, D, C, B, A**

Possibility to select a lower gain in steps. Default setting is D.

**Note.** Original P. I. D. will always be shown in display

The menu contents are shown in the figures on the right and the texts are described below:



**Current values can be read using the Read Menu and some values can be reset.**

- Pos** Shows current position
- Set&pos** Set point and position
- Set&dev** Set point and deviation
- Pos graph** Shows position graph
- Temp** Shows current temperature

**Statistics**

- n cycles** Shows number of cycles.  
1 cycle = [move of valve + change direction + move opposite direction] regardless of size of each move/stroke.

- Acc travel** Travel = [accumulated % valve has moved/100].  
  
Example: move 60% up + move 40% down =>Acc travel = 1

- mean dev** Shows accumulated deviation in %

- m.abs dev** Shows accumulated absolute deviation in %

- # of resets** Shows number of resets

- runtime** Shows accumulated runtime since last reset

- Extr temp** Shows extreme min and max temperature

- Histogram** Shows position and time for position value

- Alarms** Displays tripped alarms

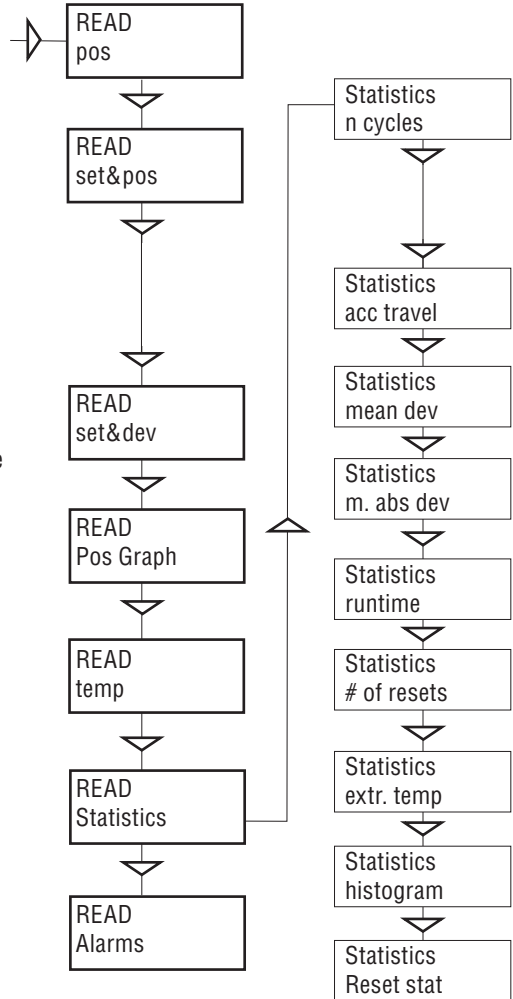





**The Man/Auto menu is used to change between manual and automatic modes.**

The menu contents are shown in the figures on the right and the various texts are described below:

**AUT, OK = MAN**



Positioner in automatic mode

**MAN, OK = AUT**

Positioner in manual mode



When changing between **MAN** and **AUT** mode, the **OK** button must be pressed for 3 seconds.

In the **MAN** mode, the value of POS can be changed using  . The push-buttons increase/decrease the value in steps. The value can also be changed in the same way as for the other parameter values, as described on page 14

**Other functions**

C+ can be fully opened by pressing  and then immediately **OK** simultaneously.

C- can be fully opened by pressing  and **OK** simultaneously.

C+ and C- can be fully opened for blowing clean by pressing   and **OK** simultaneously.



**The Shift Menu is used to choose between the basic menu and the full menu.**

The menu contents are shown in the figures on the right and the various texts are described below:

- No** Full menu selected.
- Yes** Basic menu selected.

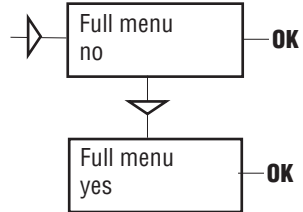

The Menu can be locked with a passcode, see Setup menu.



**The Status Menu is used to select whether or not the positioner is in service.**

The menu contents are shown in the figures on the right and the various texts are described below:

- o o service** Not in service. Flashing indicator in upper left-hand corner of display.
- in service** Positioner in service. Critical parameters cannot be changed.

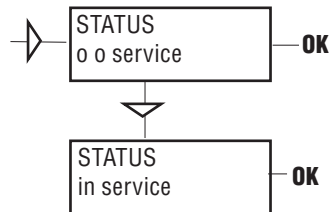

When changing between **In service** and **Out of service**, the **OK** button must be pressed for 3 seconds.



**The Setup Menu is used for various settings.**

The menu contents are shown in the chart on the next page and the various texts are described below:

<b>Actuator</b>	<b>Type of actuator</b>	<b>Size of actuator</b>	<b>Time out</b>
Rotating	Rotating actuator.	Small	10 s
Linear	Linear actuator.	Medium	25 s
		Large	60 s
		Extra large	180 s

- Lever** **Only for linear actuator.**
- Lever stroke: Stroke length to achieve correct display. Input only needed in case display value is off
  - Level cal: Calibration of positions to achieve correct display.

- Direction**
- Direct: Direct function (signal increase opens). Indicator/spindle rotates counter-clock wise.
  - Reverse: Reverse function.

**Character** **Curves that show position as a function of input signal.**

- Linear
  - Equal %
  - Quick open
  - Sqr root
  - Custom
- See diagram.
- Create own curve.

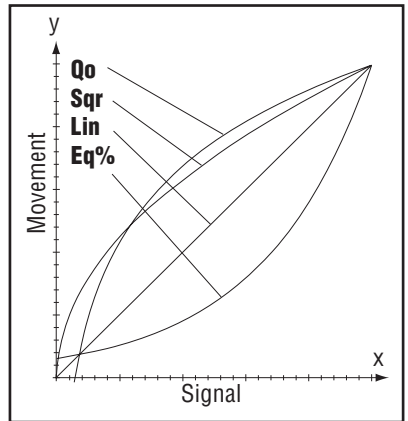

- Cust chr**
- # of point: Specify number of points (3, 5, 9, 17, or 33)
  - Cust curve: Enter values on X and Y axes.

**Curr range (Use this function to split range)**

- 0%=4.0 mA**
  - 100%=20.0 mA**
- Possibility of selecting which input signal values will correspond to 0% and 100% movement respectively. Examples of settings: 4 mA = 0%, 12 mA = 100%, 12 mA = 0%, 20 mA = 100%.

**TRVL range**  
 0%=0.0%  
 Set 0%  
 100%=100.0%  
 Set 100%

**Setting end positions**  
 Select Out of Service. Set percentage value for desired end position (e.g. 3%).  
 Select In Service. Connect calibrator. Move forward to desired end position (0%) and press OK.  
 Select Out of Service. Set percentage value for desired end position (e.g. 97%).  
 Select In Service. Connect calibrator. Move forward to desired end position (100%) and press OK.

**Trvl ctrl**  
 Set low  
 Set high  
 Values

**Behavior at set end position**  
 Choose between Free (positioner will control until a mechanical top is reached), Limit (stop at set end position), and Cut off (Default value. Go directly to a mechanical stop at a redefined setpoint).  
 Similar to Set low.  
 Select position for Cut off and Limit at the respective end positions.

**Passcode**  
 Numbers between 0000 and 9999 can be used as passcodes. 0 = no passcode required.

**Appearance**  
 Language  
 Units  
 Def. Display

**On display**  
 Select menu language.  
 Select units.  
 Select value(s) to be displayed during service. The display reverts to this value 10 minutes after any change is made.

Start menu Start in Basic menu or Full menu.  
 Orient Orientation of text on display.  
 Par mode Display of control parameters such as P, I, D or K, Ti, Td.

**Devicedata**  
 HW rew  
 SW rew  
 Capability  
 HART

} General parameters.  
 Menu with HART parameters. Only amendable with HART communicator. It is possible to read from display.

Profibus PA  
 Status Indicates present status  
 Device ID Serial number  
 Address 1-126  
 Tag Allotted ID  
 Descriptor ID description  
 Date SW release date  
 Failsafe Value = preset pos  
 Time = Set time +10sec= time before movement  
 Valve act = failsafe (preset pos) or last value (present pos)  
 Alarm out= On/Off

Foundation Fieldbus  
 Device ID Serial number  
 Nod address Address on the bus provided by the DCS system  
 TAG-PD\_TAG Name provided by the DCS system  
 Descriptor D30 positioner  
 Date SW release date  
 Sim jumper Simulate jumper, FF simulation functionality activated = ON



The menu contents are shown in the chart on the next page and the various texts are described below:

- Close time**      Minimum time from fully open to closed.
- Open time**      Minimum time from closed to fully open.
- Deadband**      Setting deadband. Min. 0.1%.
  
- Expert**          Advanced settings.
- Control**        See explanations below.
  
- Togglestep**    Test tool for checking functions. Overlays a square wave on the set value.
  
- Self test**      Internal test of processor
  
- Undo**          You can read last 20 changes.

**P,I,D and K,Ti,Td parameters**

If one of the gains is changed, the corresponding value in the other gain set is changed accordingly.

**FULL MENU  
ALARMS**

The menu contents are shown in the chart on the next page and the various texts are described below:

**Deviation Alarm generated when deviation occurs**  
 On/Off Alarm on/off.  
 Distance Allowed distance before alarm is generated.  
 Time Total deviation time before alarm is generated.  
 Alarm out Select ON/OFF offers output on terminals.  
 Valve act Behavior of valve when alarm is generated.

**Limit 1 Alarm above/below a certain level.**  
 On/Off Alarm on/off.  
 Minipos Setting of desired min. position.  
 Maxpos Setting of desired max. position.  
 Hysteresis Desired hysteresis.  
 Alarm on Select ON/OFF offers output on terminals.  
 Valve act Behavior of valve when alarm is generated.

} See diagram below!

**Limit 2 See Limit 1.**

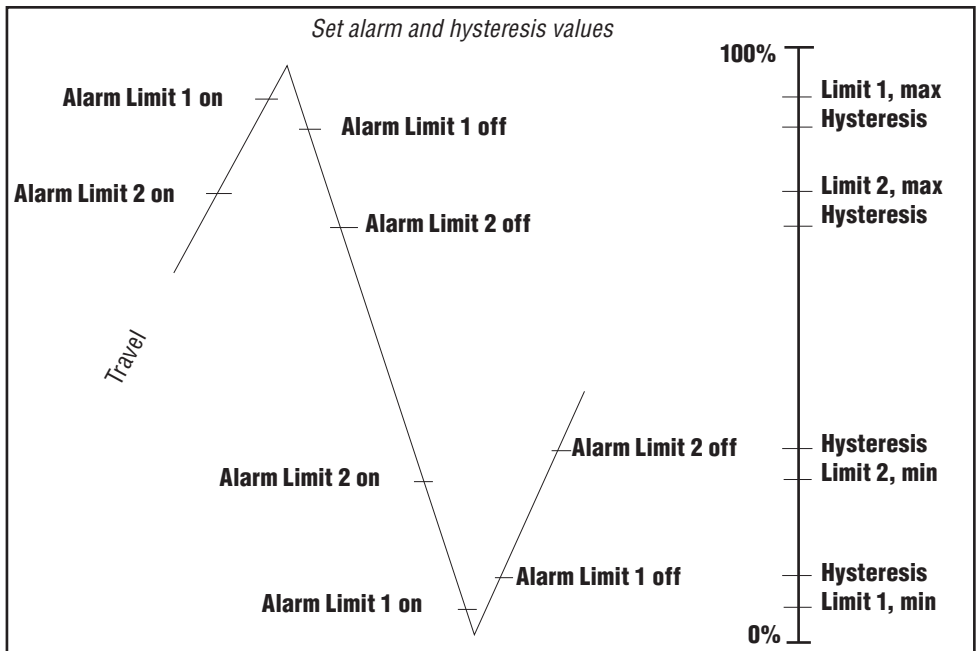

**Temp**

On/Off  
 Low temp  
 High temp  
 Hysteresis  
 Alarm out  
 Valve act

**Alarm based on temperature**

Temperature alarm on/off.  
 Temperature setting.  
 Temperature setting.  
 Allowed hysteresis.  
 Select ON/OFF offers output on terminals.  
 Behavior of valve when alarm is generated.

**Valve act**

No action	Alarm generated only. Operations not affected.
Goto open	Valve moves to 100%. Positioner changes to position Manual.
Goto close	Valve moves to 0%. Positioner changes to position Manual.
Manual	Valve stays in unchanged position. Positioner moves to position Manual.

## Expert Calibration

When entering “ExpertCal” mode - walk through the list of parameters described below. Set values where applicable. Confirm by pressing OK.

**Set point LO:** Use the calibrator set to 4 mA (or set another value on the display). Press OK.

**Set point HI:** Use a calibrator of 20 mA (or set another value on the display). Press OK.

**Pressure LO:** Use a supply of 1.4 bar (20 psi) (or set another value on the display). Press OK. Pressure read out only possible on D30 with built in pressure sensor.

**Pressure HI:** Use a supply of 8 bar (115 psi) (or set another value on the display). Press OK. Pressure read out only possible on D30 with built in pressure sensor.

**Transmitter:** Connect 10 - 28 VDC. Connect an external mA meter to the loop. Read low value on mA meter and adjust with up/down key. Press OK to set low value. Repeat procedure to set High value. Also see video on [www.pmv.nu](http://www.pmv.nu)

**Pot:** Potentiometer setting, see section 5. Also see video on [www.pmv.nu](http://www.pmv.nu)

**Full reset:** Resets all set values and enters Factory mode. To reset the values only, use FACT SET in main menu, see below.



The menu contents are shown in the chart below.

The default values that were set on delivery can be reset using the Fact Set menu. Values from calibration and from other settings will then be lost.

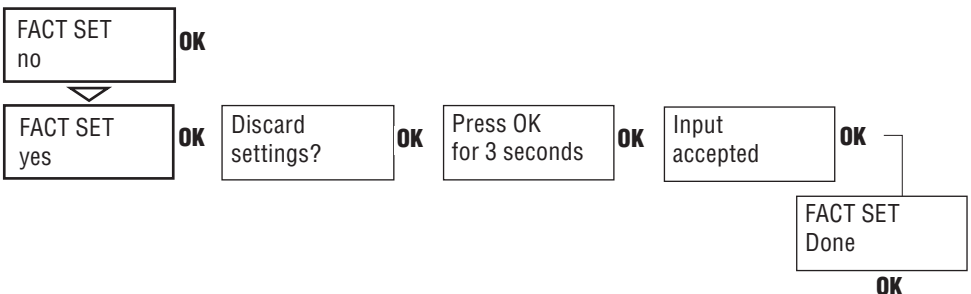





## 5. Maintenance/service

When carrying out service, replacing a circuit board, etc., it may be necessary to remove and refit various parts of the positioner. This is described on the following pages.

**Read the Safety Instructions on [page 4](#) and [5](#) before starting work on the positioner.**

**Cleanliness is essential when working with the positioner. Contamination in the air ducts will inevitably lead to operational disturbances. Do not disassemble the unit more than that described here.**

**DO NOT take the valve block apart because its function will be impaired.**

**When working with the D30 positioner, the work place must be equipped with ESD protection before the work is started.**



**Always turn off the air and electrical supplies before starting any work.**



**Please see section for special conditions for safe use and spare parts on [page 5](#)!**

**Please contact a Flowserve office for information regarding proper procedures.**  
[www.pmv.nu](http://www.pmv.nu) or [infopmv@flowserve.com](mailto:infopmv@flowserve.com)

### Disassembling D30

#### Removing cover and inner cover

- Unscrew the screws A and remove the cover. When mounting cover – see [page 5](#).
- Pull off the arrow pointer, B.
- Unscrew the screws C and remove the inner cover.

Note: Removing inner cover will void warranty.

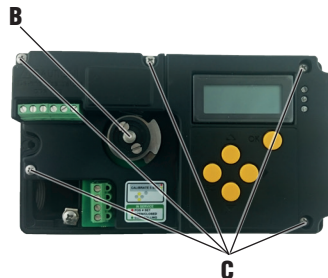
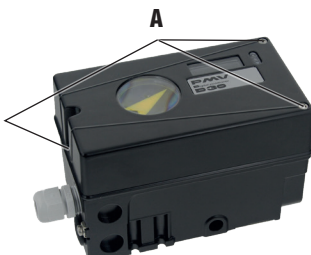

## Circuit boards (PCB)



**Disconnect or switch off the electric power supply before starting any work.**

- Lift off the display PCB..
- Release the cable connections.
- Unscrew the two screws B and lift up the circuit board.

**B**

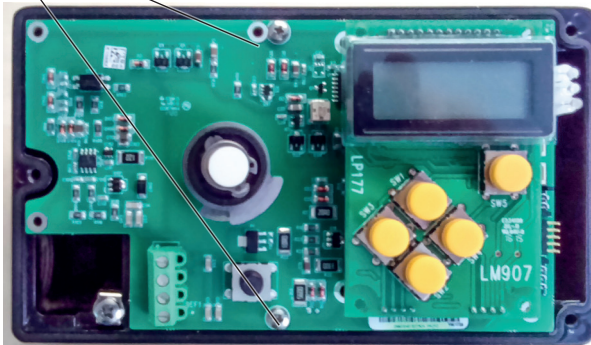

## Limit Switches

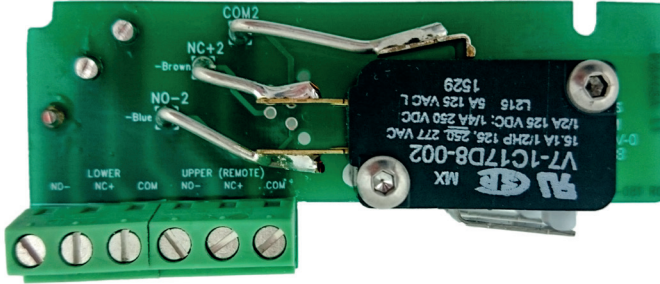

When installing the switch card, make sure it is placed correctly. Secure the PC board with the two screws. Make sure the holes are centred before tightening the screws.

**Note!** When installing the cam assembly for mechanical switches, retract both switch arms first.

Install the cam assembly and tighten the screws loosely to obtain enough friction to lock the cams.

Adjust the lower cam first, then the upper cam.

## Valve block



**Turn off the air and electric power supply before starting any work.**

- Remove the three screws A and lift out the valve block

### N.B. Do not disassemble the valve block

- When installing the valve block — torque the three screws to 0,4 Nm and seal with Loctite® 222.

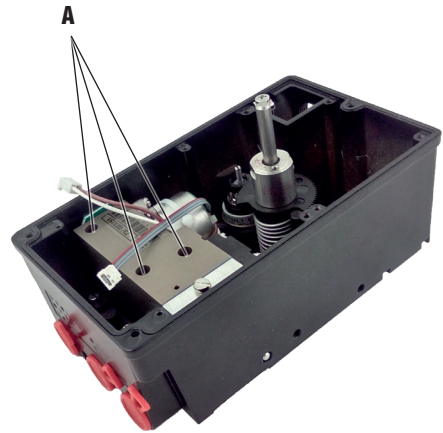

## Pressure sensors

Three pressure sensors are available as an option. They indicate pressure for supply, C- and C+ air, and can be used by ValveSight™ to enable advanced valve diagnostics.

The sensors are mounted on a circuit board which mounts next to the air relay on the floor of the housing at B using three screws.

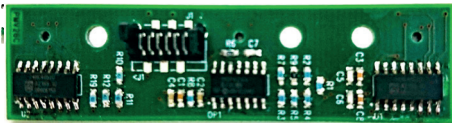

**Pressure sensor PCB - top view**

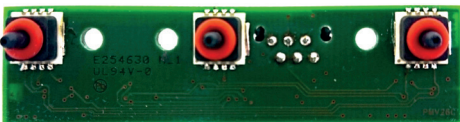

**Pressure sensor PCB - bottom view**

**Potentiometer**

**90° spring loaded potentiometer**

The spring-loaded potentiometer can be removed from the gearwheel for calibration or replacement.

If the potentiometer is replaced or the setting is changed, it must be calibrated.

- Select the menu Calibrate - Expert - Cal pot. The display shows Set gear.

- Turn the spindle shaft clockwise to end position and press OK. Either turn manually or use the up/down arrows (with supply air) to stroke the positioner to turn the shaft clockwise (see Manual mode [page 25](#)).
- Move spring (1) aside and disengage cogwheels. Turn potentiometer according to display until OK is shown. Press OK. See drawing below.
- Move back spring (1) and secure potentiometer (2) calibration. See drawing below.

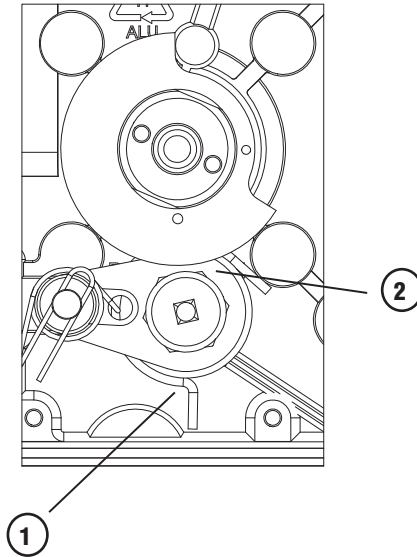

## 6. Trouble shooting

Symptom	Action
Input signal change to positioner does not affect actuator position.	<ul style="list-style-type: none"> <li>• Check air supply pressure, air cleanliness, and connection between positioner and actuator.</li> <li>• Out of service, in manual mode.</li> <li>• Check input signal to positioner.</li> <li>• Check mounting and connections of positioner and actuator.</li> </ul>
Change in input signal to positioner makes actuator move to its end position.	<ul style="list-style-type: none"> <li>• Check input signal.</li> <li>• Check mounting and connections of positioner and actuator.</li> </ul>
Inaccurate control.	<ul style="list-style-type: none"> <li>• Perform Auto-calibration and check for any leaks.</li> <li>• Uneven air supply pressure.</li> <li>• Uneven input signal.</li> <li>• Wrong size of actuator being used.</li> <li>• High friction in actuator/valve package.</li> <li>• Excess play in actuator/valve package.</li> <li>• Excess play in mounting of positioner on actuator.</li> <li>• Dirty/humid supply air.</li> </ul>
Slow movements, unstable regulation.	<ul style="list-style-type: none"> <li>• Implement auto-tuning.</li> <li>• Increase the deadband (Tuning menu).</li> <li>• Adjust Performance (Calibrate menu).</li> </ul>

## 7. Technical data

---

Rotation angle	min 25° max 100°
Stroke	From 5 mm (0.2")
Input signal	4-20 mA DC
Air supply	1.4-8 barg (20-115 psi) DIN/ISO 8573-1 3.2.3 Free from oil, water and moisture.
Air delivery	Up to 760 nl/min @ 6 bar (29.3 scfm @ 87 psi)
Air consumption	8 nl/min @ 6 bar (0.31 scfm @ 87 psi)
Air connections	¼" G or NPT
Cable entry	2x M20x1.5 or ½" NPT
Electrical connections	Screw terminals 2.5 mm <sup>2</sup> /AWG14
Linearity	<0.4%
Repeatability	<0.5%
Hysteresis	<0.3%
Dead band	0.1-10% adjustable
Display	Graphic, view area 15 x 41 mm (0.6 x 1.6")
UI	5 push buttons
CE directives	93/68EEC, 89/336/EEC, 92 /31/EEC
Voltage drop, w/o HART	8 V
Voltage drop, with HART	9.4 V
Enclosure	IP66
Material	Die-cast Aluminum
Surface treatment	Powder epoxy
Temperature range	-40°C to +80°C (-40°F to 176°F)
Weight	1.8 kg (4 lbs)
Mounting position	Any
Communication protocols	Hart, Profibus PA, Foundation Fieldbus



<b>Mechanical switches</b>	
Type	SPDT
Size	V3
Rating	3 A/125 VAC / 2 A/30 VDC
Temperature range	-40°C to 80°C (-22°F to 180°F)

<b>NAMUR sensors</b>	
<b>(NJ2-V3-N)</b>	
Type	Proximity DIN EN 60947-5-6:2000
Load current	1 mA ≤ I ≤ 3 mA
Voltage range	8 VDC
Hysteresis	0.2%
Temperature range	-25°C to 85°C (-13°F to 185°F)

<b>Proximity switches</b>	
Type	SPDT
Rating	0.4 A @ 24 VDC, Max 10 W
Operating time	Max 1.0 ms
Max voltage	200 VDC
Contact resistance	0.2 Ω
Temperature range	-40°C to 80°C (-22°F to 180°F)

<b>Slot NAMUR switches</b>	
<b>(SJ2-SN, SJ2-N)</b>	
Type	Proximity DIN EN 60947-5-6:2000
Load current	1 mA ≤ I ≤ 3 mA
Voltage	8 VDC
Hysteresis	0.2%
Temperature range	-25°C to 85°C (-40°F to 185°F) SJ2-N -40°C to 85°C (-40°F to 185°F) SJ2-SN

<b>4-20 mA transmitter</b>	
Supply	11-28 VDC
Output	4-20 mA
Resolution	0.1%
Linearity full span	+/-0.5%
Output current limit	30 mA DC
Load impedance	800 Ω @ 24 VDC

# 8. Dimensions

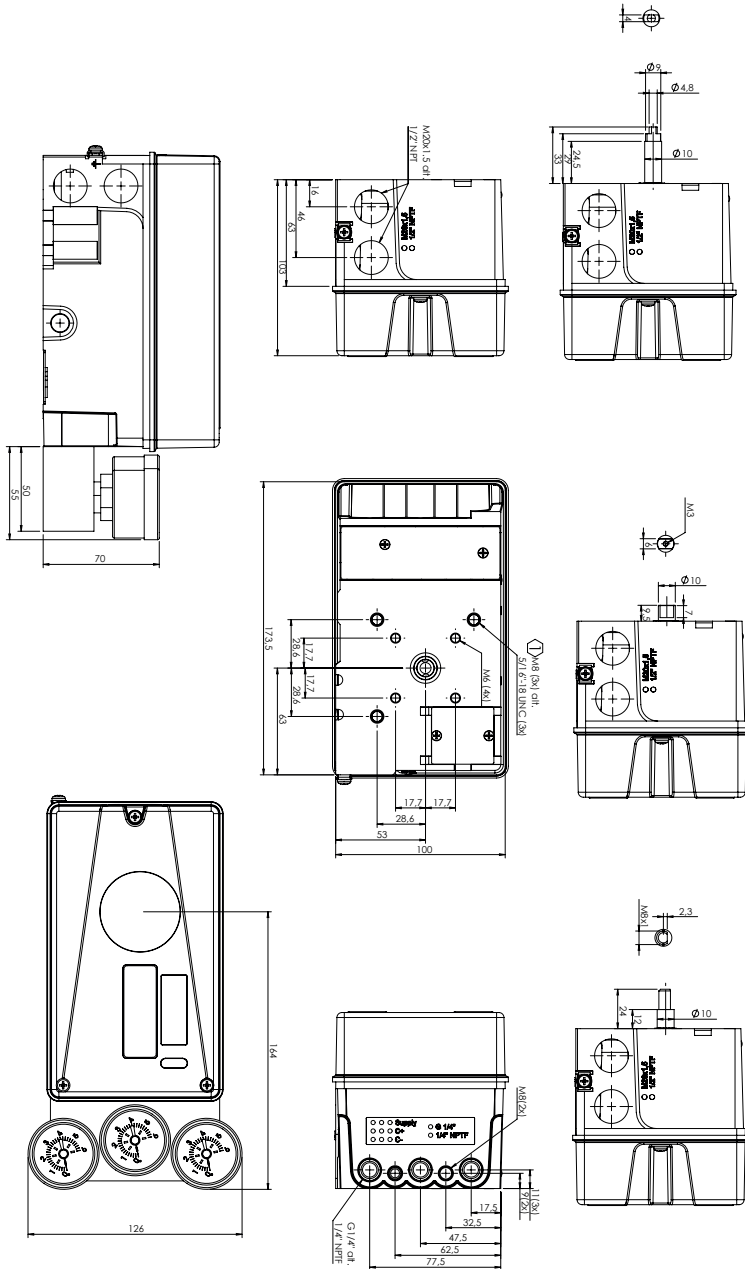

## 9. Spare parts

No	Part no	Description
1	D4-SP37PVA	Black cover incl. screws and flat indicator
1	D4-SP37FWA	White cover incl. screws and flat indicator
2	D4-SP40	Internal cover incl. screws
3	D4-SP1516	External covers SST, 2, incl screws
4	3-SXX	Spindle adaptor (XX = 01, 02, 06, 26, 30, 36)
5	D4-SP05-09	S09 shaft compl. incl. gear wheel, friction clutch, spring
5	D4-SP05-21	S21 shaft compl. incl. gear wheel, friction clutch, spring
5	D4-SP05-23	S23 shaft compl. incl. gear wheel, friction clutch, spring
5	D4-SP05-39	S39 shaft compl. incl. gear wheel, friction clutch, spring
6	D4-SP400	Air relay complete, incl. cable, seal, screws
7	D4-SP08	Potentiometer compl. incl. spring, bracket, cable
8	3-SP37HR	PCB LCD assembly
9	D4-SP7-80H	PCB mother board 4-20 mA / HART
9	D4-SP7-80P	PCB mother board Profibus PA
9	D4-SP7-80F	PCB mother board Fieldbus
10	D4-SP84-3	Pressure sensor assembly complete
11	D4-SPGB	Bag with screws, O-rings, seals, pair of sintered brass silencers, cable gland
12	D4-SP940M	Gauge block G, complete incl. screws, seals, 3 gauges / SST, Brass
12	D4-SP940N	Gauge block G, complete incl. screws, seals, 3 gauges / SST, Brass
13	D4-SP45S	Limit switches Mechanical SPDT compl.
13	D4-SP45N	Limit switches Namur V3 P&F NJ2-V3-N compl.
13	D4-SP45P	Limit switches Proximity SPDT compl.
13	D4-SP455	Limit switches Namur slotted P&F SJ2-SN compl.
13	D4-SP456	Limit switches Namur slotted P&F SJ2-N compl.

Note: PMV does not offer spare parts for certified units

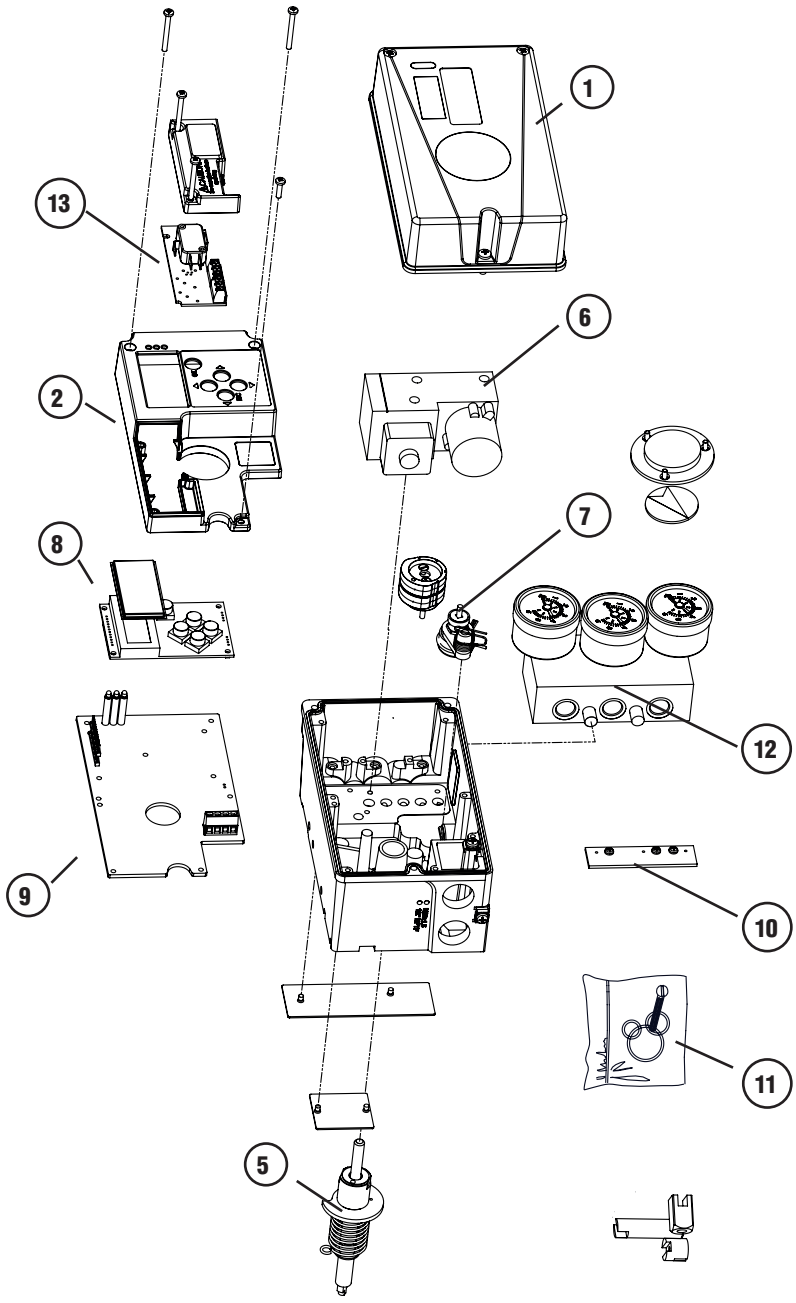







## FCD PMENIM0030-01-A5 – 05/18

To find your local Flowserve representative:

To find your local Flowserve representative please use the Sales Locator

System found at [www.flowserve.com](http://www.flowserve.com)

Flowserve Corporation has established industry leadership in the design and manufacture of its products. When properly selected, this Flowserve product is designed to perform its intended function safely during its useful life. However, the purchaser or user of Flowserve products should be aware that Flowserve products might be used in numerous applications under a wide variety of industrial service conditions. Although Flowserve can provide general guidelines, it cannot provide specific data and warnings for all possible applications. The purchaser/user must therefore assume the ultimate responsibility for the proper sizing and selection, installation, operation, and maintenance of Flowserve products. The purchaser/user should read and understand the user instructions included with the product, and train its employees and contractors in the safe use of Flowserve products in connection with the specific application.

While the information and specifications contained in this literature are believed to be accurate, they are supplied for informative purposes only and should not be considered certified or as a guarantee of satisfactory results by reliance thereon. Nothing contained herein is to be construed as a warranty or guarantee, express or implied, regarding any matter with respect to this product. Because Flowserve is continually improving and upgrading its product design, the specifications, dimensions and information contained herein are subject to change without notice. Should any question arise concerning these provisions, the purchaser/user should contact Flowserve Corporation at any one of its worldwide operations or offices.

For more information about Flowserve Corporation, contact [www.flowserve.com](http://www.flowserve.com) or call USA 1-800-225-6989.

© May 2018, Flowserve Corporation, Irving, Texas

### **PMV Automation AB**

Korta Gatan 9  
SE-171 54 SOLNA  
SWEDEN  
Phone: +46 (0)8-555 106 00  
E-mail: [infopmv@flowserve.com](mailto:infopmv@flowserve.com)

### **PMV USA**

14219 Westfair West Drive  
Houston, TX 77041, USA  
Phone: +1 281 671 9209  
Fax: +1 281 671 9268  
E-mail: [pmvsales@flowserve.com](mailto:pmvsales@flowserve.com)

### **Flowserve Flow Control**

Burrell Road, Haywards Heath  
West Sussex RH16 1TL  
Phone: +44(0)1444 314400  
E-mail: [pmvuksales@flowserve.com](mailto:pmvuksales@flowserve.com)

### **Flowserve Flow Control Benelux**

Rechtzaad 17  
4703 RC Roosendaal  
THE NETHERLANDS  
Phone: +31 (0) 30 6771946  
Fax: +27 (0) 30 6772471  
E-mail: [fbinfo@flowserve.com](mailto:fbinfo@flowserve.com)

### **Flowserve Flow Control GmbH**

Rudolf-Plank Strasse 2  
D-76275 Ettlingen  
GERMANY  
Phone: +49 (0) 7243 103 0  
Fax: +49 (0) 7243 103 222  
E-mail: [argus@flowserve.com](mailto:argus@flowserve.com)

### **Flowserve Corporation**

No. 35, Baiyu Road  
Suzhou Industrial Park  
Suzhou 215021, Jiangsu Province,  
PRC  
Phone: +86-512-6288-1688  
Fax: +86-512-6288-8737

### **Flowserve (China)**

585, Hanwei Plaza  
7 Guanghau Road  
Beijing, China 100004  
Phone: +86 10 6561 1900

### **Flowserve Pte Ltd**

No. 12 Tuas Avenue 20  
Singapore 638824  
Phone: +65 6879 8900  
Fax: +65 6862 4940

### **Flowserve do Brasil Ltda**

Rua Tocantins, 128 - Bairro Nova Gerti  
São Caetano do Sul,  
São Paulo 09580-130 Brazil  
Phone: +5511 4231 6300  
Fax: +5511 4231 6329 - 423