

ARGUS Ball Valve FK and HK

High Performance Ball Valves

VAIOM001024

Installation Operation Maintenance

Translation of the Original Instructions



These instructions must be read and observed before using an ARGUS ball valve.

Also read and observe the superior instructions VAIOM001028 before using an ARGUS ball valve automated by Flowserve Flow Control GmbH.





Copyright Notice

All rights reserved. No part of these instructions may be reproduced, stored in a retrieval system or transmitted in any form or by any means without the prior consent of Flowserve Corporation.

Document Version

Rev.: 02, 08. Nov. 2023

Table of Contents

1	General Information	6
1.1	Aim of These Instructions	6
1.2	Exclusion of Liability	6
1.3	Safety Information	7
1.4	Units	13
1.5	Graphic Conventions for Special Designations	13
1.6	ARGUS Ball Valve as Pressure Equipment	13
1.7	ARGUS Ball Valve as “Partly Completed Machinery”	13
1.8	Operating Parameters/Limits of the ARGUS Ball Valve	14
1.9	Nameplate: Identification of the ARGUS Ball Valve	14
2	Safety Information	16
2.1	Grouped Safety Messages	16
2.2	Responsibility of the Owner Company	22
2.3	Qualified Personnel	23
2.4	Personal Protective Equipment	23
2.5	Personnel Qualification	24
2.6	Target Groups	24
2.7	Notes on Product Warranty	25
2.8	Intended Use	26
2.9	Non-intended Use	26
2.10	General Sources of Danger/Residual Risks	27
3	Product Description	29
3.1	General Product Description	29
3.2	Design Features	29
3.3	Scope of Delivery	30
4	Consignment Receipt	31
4.1	Safety Messages	31
4.2	Checking the Consignment Receipt for Completeness	31
4.3	Unpacking the ARGUS Ball Valve	31
5	Installation	32
5.1	Safety Messages	32

5.2	Preparing the Flange and Welded Installation	33
5.3	Installing the ARGUS Ball Valve via a Flange Connection.....	33
5.4	Installing the ARGUS Ball Valve via a Welded Connection.....	35
5.5	Installing/Aligning the Actuator.....	37
6	Commissioning	38
6.1	Safety Messages.....	38
6.2	Requirements for Commissioning.....	39
6.3	Flushing and Pressure Testing of the Piping.....	39
6.4	Operating the ARGUS Ball Valve	39
7	Maintenance	42
7.1	Safety Messages.....	42
7.2	Required Spare Parts for Maintenance	43
7.3	Maintenance Schedule	43
8	Troubleshooting Guide	44
8.1	Safety Messages.....	44
8.2	Required Spare Parts for Repair Works.....	44
8.3	Troubleshooting Table	45
8.4	Tightening the Stuffing Box Nuts or Replacing the Stuffing Box Packing	46
8.5	Replacing the Live Loading Stuffing Box Packing	48
8.6	Draining the ARGUS Ball Valve with the Drain Plug (if present)	49
8.7	Draining the ARGUS Ball Valve with the Safety Plug (if present)	50
8.8	Returning the ARGUS Ball Valve for Repair	52
9	Decommissioning and Disassembly	54
9.1	Safety Messages.....	54
9.2	Decommissioning and Disassembly of the ARGUS Ball Valve	54
10	Storage	56
10.1	Safety Messages.....	56
10.2	Storing the ARGUS Ball Valve	56
11	Packaging.....	58
11.1	Safety Messages.....	58
11.2	Packaging the ARGUS Ball Valve	58

12 Transportation	60
12.1 Safety Messages	60
12.2 Transporting the ARGUS Ball Valve	61
13 Disposal and Recycling	63
13.1 Safety Messages	63
13.2 Disposing and Recycling the ARGUS Ball Valve	64
Annex A: Declaration of Conformity	65
Annex B: Declaration of Incorporation	66
Annex C: Pressure-Temperature Diagrams for Ball Seats	67
Annex D: Max. Permissible Screw Tightening Torques for Stuffing Box	68
Annex E: Centers of Gravity of FK 75M, FK 75F, FK 76M series	70
Annex F: Safe Working Load (SWL) of Attachment Points	71

Overview of the Standard ARGUS Ball Valve Versions

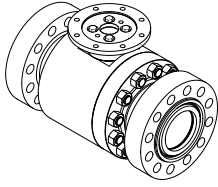
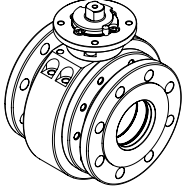
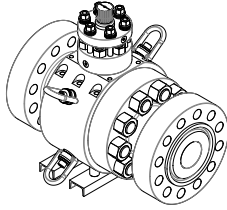
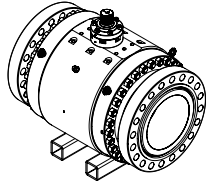
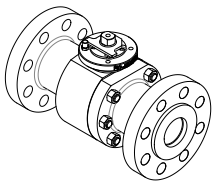
Make		Argus				
						
Series		HK 35	FK 75M / FK 75	FK 75F	FK 76M / FK 76	FK 79
Design		Trunnion-mounted ball	Floating ball	Floating ball	Trunnion-mounted ball	Floating ball
DN range		DN 40 – 500, 1½" – 20"	DN 80 – 200, 3" – 8"	2" – 20"	DN 80 – 900, 3" – 36"	DN 15 – 100, ½" – 4"
		Full or reduced passage	Full or reduced passage	Full or reduced passage	Full or reduced passage	Full or reduced passage
PN-range	PN	10 – 250	16 – 40	n/a	16 – 160	16 – 250
	ANSI/ASME Class	600 – 2500	150 – 300	150 – 2500	150 – 900	150 – 2500
Connections		Flange connection	Flange connection	Flange connection	Flange connection	Flange connection
Body materials		<ul style="list-style-type: none"> – Fine-grain steels (forged or cast) – High-grade steels – Special steels e.g. Duplex SS Monel Inconel Hastelloy Alloy 20	<ul style="list-style-type: none"> – Fine-grain steels (forged or cast) – High-grade steels – Special steels e.g. Duplex SS Monel Inconel Hastelloy Alloy 20	<ul style="list-style-type: none"> – Fine-grain steels (forged) – Stainless steels – Special steels 	<ul style="list-style-type: none"> – Fine-grain steels (forged or cast) – High-grade steels – Special steels e.g. Duplex SS Monel Inconel Hastelloy Alloy 20	<ul style="list-style-type: none"> – Fine-grain steels (forged or cast) – High-grade steels – Special steels e.g. Duplex SS Monel Inconel Hastelloy Alloy 20
Ball seal (seat materials)		<ul style="list-style-type: none"> – POM – DEVLON – PEEK (LYTON) – ARGULOY (metallic) – CRABIDE (metallic) 	<ul style="list-style-type: none"> – PTFE – POM – DEVLON – PEEK (LYTON) – ARGULOY (metallic) – CRABIDE (metallic) 	<ul style="list-style-type: none"> – ARGULOY (metallic) 	<ul style="list-style-type: none"> – PTFE – POM – DEVLON – PEEK (LYTON) – ARGULOY (metallic) – CRABIDE (metallic) 	<ul style="list-style-type: none"> – PTFE – POM – PEEK (LYTON) – ARGULOY (metallic) – CRABIDE (metallic)
Special versions & accessories		Obtainable through Flowserve catalogues and data sheets or contact Flowserve Flow Control GmbH.				



Components of a Ball Valve



This figure shows the main components of a ball valve. The delivered ball valve may be a different model.

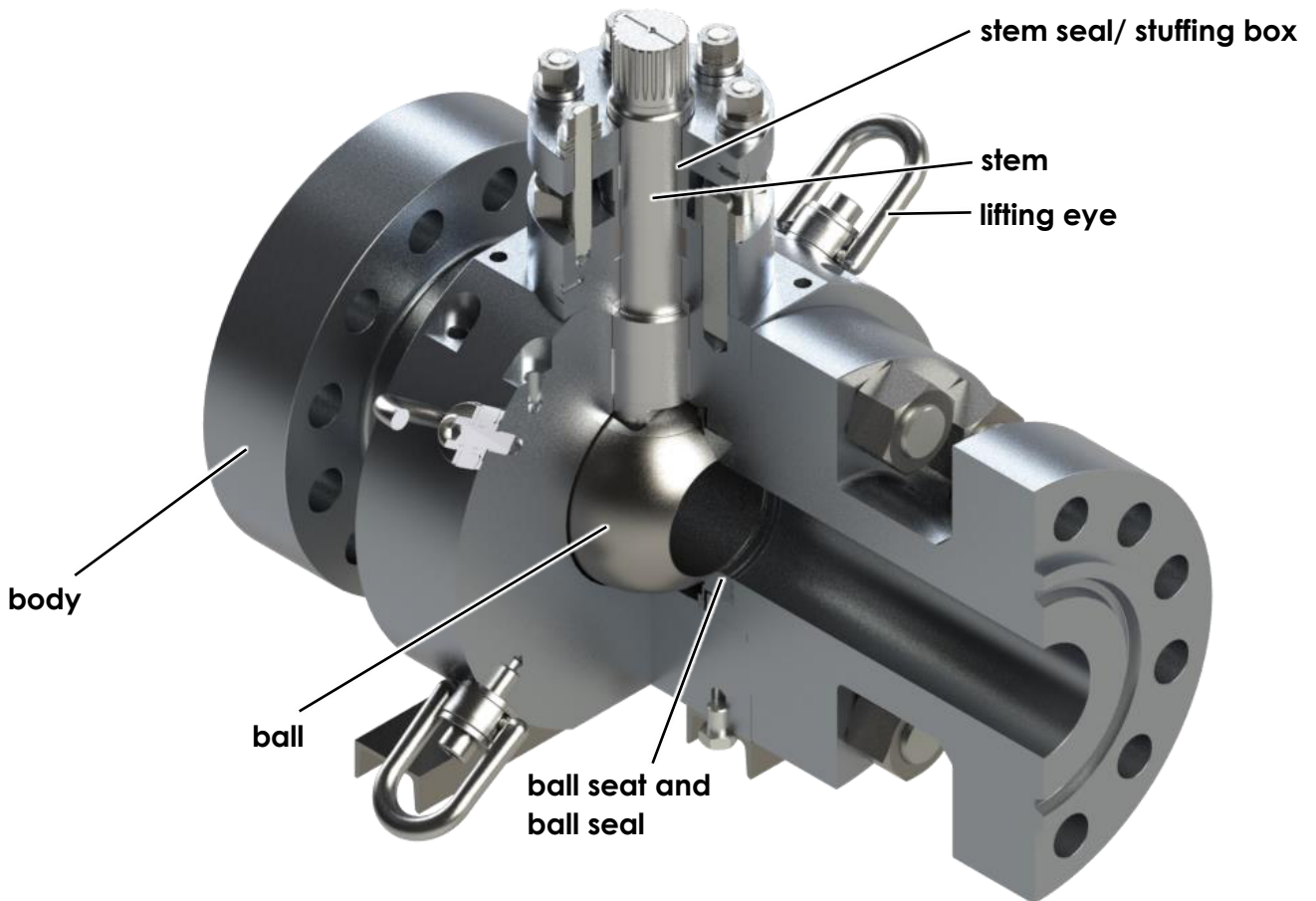



Figure 1: Components of a ball valve

1 General Information

1.1 Aim of These Instructions

These instructions are intended to familiarise the reader with the ARGUS ball valve and its proper use. Use of the ARGUS ball valve in compliance with these instructions is important to ensure its functionality and to avoid hazards.

These instructions contains information for qualified personnel for using the ARGUS ball valve for its intended purpose.

	<p>Read these instructions before using the ARGUS ball valve in any region world-wide and pay particular attention to the safety-relevant warnings, information and notes.</p> <p>Do not put the ARGUS ball valve into operation until all the safe conditions referred to in these instructions are satisfied.</p> <p>Failure to observe the information contained in these instructions will be considered as misuse of the product. Personal injury, product damages, holdups in operation or product failure due to misuse of the product are not covered by the Flowserve guarantee.</p> <p>Observe all the relevant local health and work safety regulations at the place of work – even when these are not explicitly referred to in these instructions.</p> <p>Coordinate all repair work with the operating personnel and observe all safety regulations of the industrial plant and applicable health and safety laws.</p> <p>Inform Flowserve Flow Control GmbH if documents are missing or incomplete. You will then receive replacements in electronic form.</p> <p>Provide these instructions at all workplaces near the production site.</p>
------------------------------------------------------------------------------------	--------------------------------------------------------------------------------------------------------------------------------------------------------------------------------------------------------------------------------------------------------------------------------------------------------------------------------------------------------------------------------------------------------------------------------------------------------------------------------------------------------------------------------------------------------------------------------------------------------------------------------------------------------------------------------------------------------------------------------------------------------------------------------------------------------------------------------------------------------------------------------------------------------------------------------------------------------------------------------------------------------------------------------------------------------------------------------------------------------------------------------------------------------------------------------------------------------------

1.2 Exclusion of Liability

The information in these instructions can be considered as complete and reliable. Despite all efforts of Flowserve Flow Control GmbH to supply comprehensible information and instructions, good engineering and safety practice must be applied at all times. Please consult a qualified engineer if in doubt.

Flowserve Flow Control GmbH manufacturers products according to applicable international quality management standards which are audited by external quality assurance organisations. Original spare parts and original accessories have been designed, tested and incorporated into Flowserve products to ensure continuous product quality and product performance in use. Since Flowserve Flow Control GmbH cannot test the spare parts and accessories of other manufacturers, (incorrect) installation of these parts can have a detrimental effect on the performance and safety properties of the product. The wrong choice or incorrect installation or failure to use approved Flowserve spare parts and accessories will be considered as misuse of the product. Damage or failure due to product misuse is not covered by the Flowserve guarantee. Moreover, any modifications to Flowserve products or the removal of original components can impair the safety of the products in use.

1.3 Safety Information

This safety section contains detailed explanations of the different types of safety messages that are used in these instructions.

In accordance with ANSI standard Z535.6, safety information is classified in:

- *Supplemental Directives*
- *Grouped Safety Messages*
- *Section Safety Messages*
- *Embedded Safety Messages*

Supplemental Directives are complementary safety messages containing one or more safety-relevant actions to ensure safe use of the ARGUS ball valve. *Supplemental Directives* are usually found at the beginning of a chapter in these instructions.

Grouped Safety Messages contain grouped general safety information to ensure safe use of the ARGUS ball valve. *Grouped Safety Messages* can be found in section 2.1 Grouped Safety Messages and in several safety sections of a chapter.

Section and Embedded Safety Messages warn against residual hazards which might possibly occur during proper use and improper use (reasonably foreseeable misuse) of the ARGUS ball valve.

In addition, *Section and Embedded Safety Messages* offer safety information for avoiding hazards resulting from various work situations and danger areas within the scope of the product life cycle.

Section Safety Messages can be found in the safety section of a chapter.

Embedded Safety Messages can be found in front of a potentially very dangerous action.

1.3.1 Safety Symbols and Description

These instructions contain specific safety messages with signal word fields which, if unheeded, could constitute a hazard. The specific signal word fields are:

Table 1: Explanation of the signal word fields

















Signal word field	Description
	DANGER This signal word field indicates an immediate dangerous activity which can result in death or severe injury. Observe all safety messages with this signal word field to avoid the danger.
	WARNING This signal word field indicates a potentially dangerous activity which can result in death or severe injury. Observe all safety messages with this signal word field to avoid the danger.
	CAUTION This signal word field indicates a potentially dangerous activity which can result in slight or minor injury. Observe all safety messages with this signal word field to avoid the danger.
	NOTICE This signal word field indicates an activity which can lead to material damage. Observe all safety messages with this signal word field to avoid the danger.

Table 2: Additional symbols

Symbol/Warning Sign	Description
	GENERAL DANGER Indicates a danger which can lead to danger for the safety of persons and/or material damage if not heeded.
	DANGER FROM HEAVY OBJECTS Indicates danger from a heavy object which can lead to danger for the safety of persons and/or material damage if not heeded.
	DANGER FROM EXPLOSIVE MATERIAL Indicates danger from explosive material which can lead to danger for the safety of persons and/or material damage if not heeded.

Symbol/Warning Sign	Description
	DANGER FROM MOVING PARTS Indicates danger from moving parts which can lead to danger for the safety of persons and/or material damage if not heeded.
	DANGER FROM SUSPENDED LOADS Indicates danger from a suspended load which can lead to danger for the safety of persons and/or material damage if not heeded.
	DANGER FROM TOXIC SUBSTANCES Indicates danger from toxic substances which can lead to danger for the safety of persons and/or material damage if not heeded.
	DANGER FROM HOT SURFACES Indicates danger from a hot surface which can lead to danger for the safety of persons and/or material damage if not heeded.
	DANGER FROM INFLAMMABLE MATERIALS Indicates danger from inflammable materials which can lead to danger for the safety of persons and/or material damage if not heeded.
	DANGER FROM MEDIA UNDER PRESSURE Indicates danger from media under pressure which can lead to danger for the safety of persons and/or material damage if not heeded.
	DANGER HIGH VOLTAGE Indicates danger from high voltage which can lead to danger for the safety of persons and/or material damage if not heeded.
	DANGER FROM AN EXPLOSIVE ATMOSPHERE Indicates danger from an explosive atmosphere in accordance with ATEX which can lead to danger for the safety of persons and/or material damage if not heeded.
	ENVIRONMENT HAZARD Indicates an environment hazard from environmentally harmful hazardous materials.
	HEALTH HAZARD Indicates a health hazard from irritant hazardous substances.

Symbol/Warning Sign	Description
	HEALTH HAZARD Indicates a health hazard from inflammable hazardous materials.
	HEALTH HAZARD Indicates a health hazard from explosive hazardous materials.
	Indicates a potential danger of personal injury and/or material damage. Please observe all the supplemental directives with this warning sign.
	Indicates particularly important information. Observe all general information with this symbol.
1. 2. 3.	Introduces an action.
	Indicates a prerequisite for an action referring to a subsequent action.
	Indicates a secondary action or an action within a safety directive.
	Indicates the result of previous actions.
■	Indicates a list entry.

1.3.2 Graphic Convention and Content Structure of the General Information

The following graphic conventions and content structure apply for general information:

General information

Example:

These instructions contain further information about the use of the ARGUS ball valve.

1.3.3 Graphic Convention and Content Structure of Safety Directives

Supplemental Directives

The following graphic convention and content structure apply for Supplemental Directives:

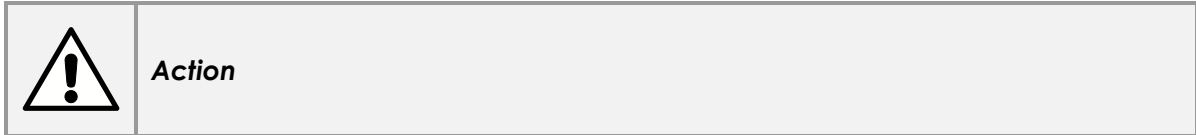

Example:

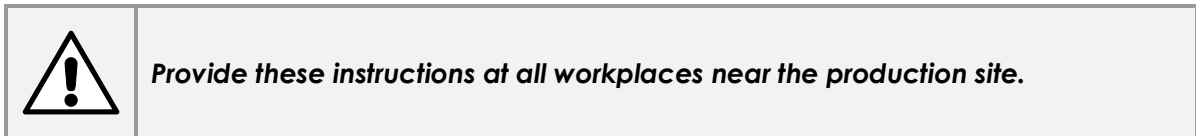

Grouped Safety Messages

The following graphic convention and content structure apply for *Grouped Safety Messages*:

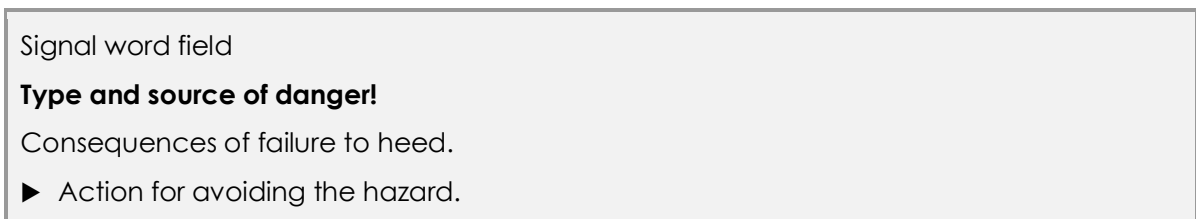

Example:

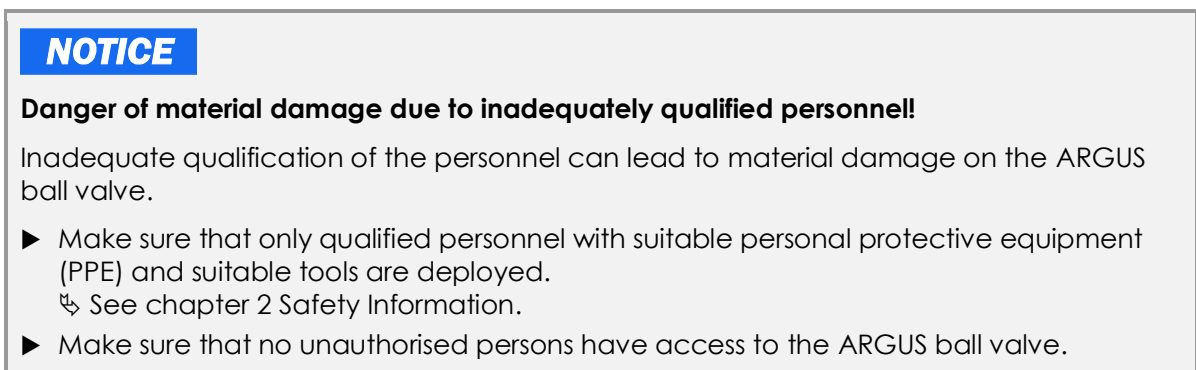

Section Safety Messages

The following graphic convention and content structure apply for *Section Safety Messages*:

Warning sign	<p>Signal word field</p> <p>Type and source of danger!</p> <p>Consequences of failure to heed.</p> <p>▶ Action for avoiding the hazard.</p>
--------------	----------------------------------------------------------------------------------------------------------------------------------------------------

<p>Signal word field</p> <p>Type and source of danger!</p> <p>Consequences of failure to heed.</p> <p>▶ Action for avoiding the hazard.</p>

Example:

	<p>WARNING</p> <p>Danger of injury due to inadequately secured loads during transport!</p> <p>Inadequate securing of transported loads can lead to severe injuries.</p> <p>▶ Secure the ARGUS ball valve against turning and tipping.</p>
-------------------------------------------------------------------------------------	---------------------------------------------------------------------------------------------------------------------------------------------------------------------------------------------------------------------------------------------------------

<p>NOTICE</p>	<p>Danger of material damage due to inadequately secured loads during transport!</p> <p>Inadequate securing of transported loads can lead to material damage.</p> <p>▶ Secure the ARGUS ball valve against turning and tipping.</p>
----------------------	--------------------------------------------------------------------------------------------------------------------------------------------------------------------------------------------------------------------------------------------

Embedded Safety Messages

The following graphic convention and content structure apply for *Embedded Safety Messages*:

<p>Signal word field</p> <p>Type and source of danger!</p> <p>Consequences of failure to heed.</p> <p>▶ Action for avoiding the hazard.</p>

Example:**⚠ DANGER****Danger of injury from falling loads!**

Falling of suspended loads can lead to severe injury or death.

- ▶ Never stand beneath suspended loads.

1.4 Units

The metric unit system (SI) is used in these instructions.

1.5 Graphic Conventions for Special Designations

The following graphic conventions apply for special designations:

- For better legibility, some special English designations consisting of two or more parts are written in *italics*.
- For better legibility, object designations (for example, buttons, text fields, switches, levers, knobs) of a product (machine or software) are written in *CAPITALS*.

1.6 ARGUS Ball Valve as Pressure Equipment

The design of ARGUS ball valves takes all relevant laws, directives, standards, and specifications into account, such as the European Directive for Pressure Equipment 2014/68/EU, EN 12516, AD 2000 Regulations, API 6D and ASME/ANSI B16.34 and others, depending on the specified application.

The careful selection, design and calculation of materials as well as quality assurance performed during materials procurement, in production and on finished products ensure the elimination of pressure-related hazards when the ARGUS ball valves are used as intended.

As a manufacturer, Flowserve Flow Control GmbH applies the conformity assessment procedure according to module H (Article 14 of European Pressure Equipment Directive 2014/68/EU), i.e., “Comprehensive Quality Assurance” as described in Appendix III, Paragraph 11.

ARGUS ball valves are marked according to the provisions of the European Pressure Equipment Directive with the CE mark as well as the identification number of the notified conformity assessment body.

For the ARGUS ball valves, which are covered by the provisions of the European Pressure Equipment Directive 2014/68/EU, the EU declaration of conformity is part of these instructions.

1.7 ARGUS Ball Valve as “Partly Completed Machinery”

The automated ARGUS ball valve, i.e., an assembly consisting of an ARGUS ball valve and a mounted pneumatic, hydraulic, or electric actuator with the corresponding control components for an automated operating of the complete automated unit, can be considered to be “machinery” in the sense of the European Machinery Directive 2006/46/EC. An ARGUS ball valve prepared for assembly with an actuator is thus regarded as “partly completed machinery” in the sense of the European Machinery Directive 2006/46/EC.

The European Machinery Directive 2006/46/EC requires that any hazards for persons and for the environment must be excluded when using the machinery.

Flowserve Flow Control GmbH certifies by the "Declaration of Incorporation" delivered with each ARGUS ball valve prepared for automation that the ARGUS ball valve poses no risks during assembly, installation into the industrial plant and during operation of the automated unit.

These instructions for the ARGUS ball valve are part of the complete documentation of the automated unit (ARGUS ball valve and actuator).

1.8 Operating Parameters/Limits of the ARGUS Ball Valve

ARGUS ball valves are designed for special applications. Series (Type), material selection, nominal size, special features, attachments, accessories, and valve qualification are adapted to the specified operating conditions. This results in operating parameters/limits concerning fluids (media), pressure, temperature, and environmental conditions for each ARGUS ball valve.

The metallic nameplate attached to the ARGUS ball valve provides information on these operating parameters/limits:

↳ See Section 1.9 Nameplate: Identification of the ARGUS Ball Valve.

-  The nameplate permanently attached to the ARGUS ball valve body indicates the operating parameters/limits of the equipment. The maximum permissible operating pressure and the maximum permissible operating temperature must never be exceeded.

1.9 Nameplate: Identification of the ARGUS Ball Valve

The nameplate permanently affixed to the ball valve body provides the most important information regarding the design and use of the ARGUS ball valve.

-  If the nameplate is missing or illegible, do not put the ARGUS ball valve into operation. Instead, contact the *Quick Response Center (QRC)* at Flowserve Flow Control GmbH for support.

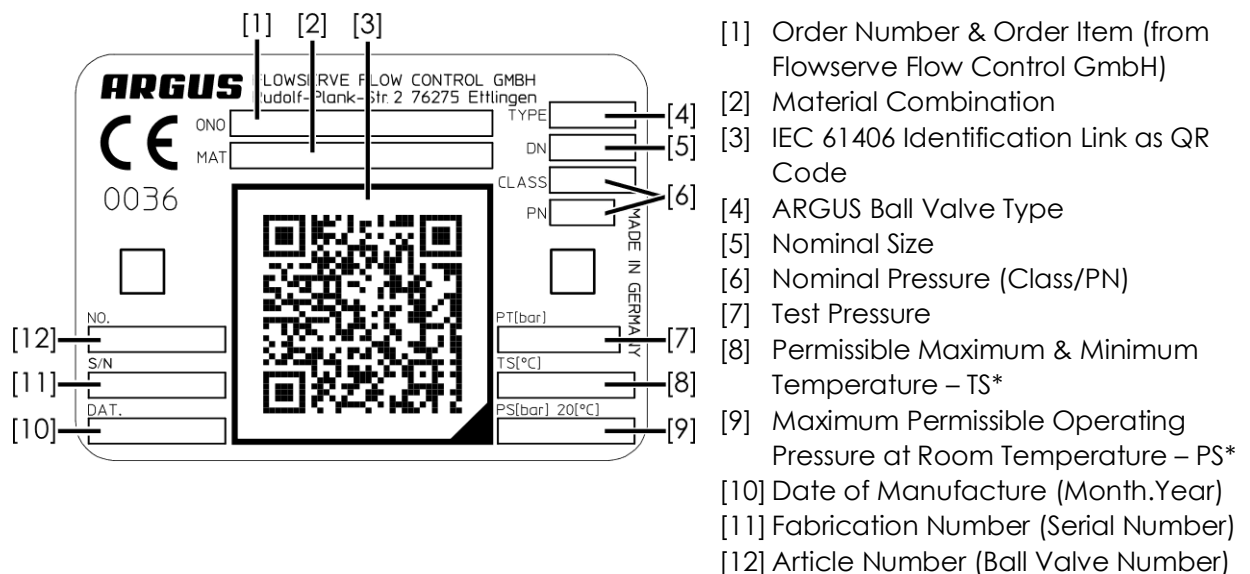

-  *Observe temperature-dependent limit values for the pressure load for non-metallic sealing material. Refer to ↳ Annex C: Pressure-Temperature Diagrams for Ball Seats.



CE marking according to European Pressure Equipment Directive 2014/68/EU (PED): According to the provisions of European Pressure Equipment Directive 2014/68/EU, ARGUS ball valves and equipment classified in Category II and above are marked with the CE symbol and the identification number of the notified body ("0036"). ARGUS ball valves in Category I are marked with "CE" only. ARGUS ball valves which, due to their design, are not covered by the Directive do not bear the CE marking.

The attached EU conformity declaration according to 2014/68/EU certifies that the provisions from the Directive have been fulfilled for the affected ARGUS ball valves and equipment.

2 Safety Information

2.1 Grouped Safety Messages

The following sections contain *Grouped Safety Messages* for the qualification of personnel and for the important life cycle phases of the ARGUS ball valve.

2.1.1 Qualification of Personnel

⚠ WARNING**Danger of injury due to inadequately qualified personnel!**

Inadequate qualification of the personnel can lead to severe injury.

- ▶ Make sure that only qualified personnel with suitable personal protective equipment (PPE) and suitable tools are deployed.
↳ See Sections 2.2 to 2.5.
- ▶ Make sure that no unauthorised persons have access to the ARGUS ball valve.

NOTICE**Danger of material damage due to inadequately qualified personnel!**

Inadequate qualification of the personnel can lead to material damage on the ARGUS ball valve.

- ▶ Make sure that only qualified personnel with suitable personal protective equipment (PPE) and suitable tools are deployed.
↳ See Sections 2.2 to 2.5.
- ▶ Make sure that no unauthorised persons have access to the ARGUS ball valve.

2.1.2 ARGUS Ball Valve Life Cycle Stages

Installation

⚠ WARNING**Risk of injury due to improper installation works!**

Improper installation works may cause severe injury or death.

- ▶ Only deploy qualified personnel with appropriate personal protective equipment (PPE) and suitable work tools.
↳ See Sections 2.2 to 2.5.
- ▶ Ensure that unauthorized persons do not have any access to the ARGUS ball valve.
- ▶ Use appropriate safety measures in the workplace to ensure that parts cannot fall off.
- ▶ Ensure that the ARGUS ball valve is designed for the special operating conditions.
- ▶ Ensure that the connections, in particular the welding parameters, comply with the design specifications of the ARGUS ball valve.
- ▶ Monitor the temperature of the valve body in the seat area by using the temperature-sensing strips during welding.
- ▶ Provide safety instructions relating the piping (including the ARGUS ball valve).
- ▶ When installing the ARGUS ball valve via flange connection, determine the required tightening torques of the bolts.
- ▶ After completing the installation and before actuating the ARGUS ball valve, make sure to flush out the piping system.

If the ARGUS ball valve is intended to serve as permanent shut-off from the atmosphere, provide a blind flange or equivalent end.

NOTICE**Risk of property damage due to improper installation works!**

Improper installation works may cause property damage.

- ▶ Only deploy qualified personnel with appropriate personal protective equipment (PPE) and suitable work tools.
↳ See Sections 2.2 to 2.5.
- ▶ Ensure that unauthorized persons do not have any access to the ARGUS ball valve.
- ▶ Use appropriate safety measures in the workplace to ensure that parts cannot fall off.
- ▶ Ensure that the ARGUS ball valve is designed for the special operating conditions.
- ▶ Ensure that the connections, in particular the welding parameters, comply with the design specifications of the ARGUS ball valve.
- ▶ Monitor the temperature of the valve body in the seat area by using the temperature-sensing strips during welding.
- ▶ Provide safety instructions relating the piping (including the ARGUS ball valve).
- ▶ When installing the ARGUS ball valve via flange connection, determine the required tightening torques of the bolts.
- ▶ After completing the installation and before actuating the ARGUS ball valve, make sure to flush out the piping system.
- ▶ If the ARGUS ball valve is intended to serve as permanent shut-off from the atmosphere, provide a blind flange or equivalent end.

NOTICE**Risk of property damage due to high temperatures during welding!**

High temperatures due to welding may damage the ball sealing.

- ▶ Monitor the temperature of the valve body in the seat area by using the temperature-sensing strips during welding.

NOTICE**Risk of environmental pollution due to fluid residues!**

Fluid residues may harm the environment.

- ▶ Handle fluid residues with care.
- ▶ Temporarily place the ARGUS ball valve in the half-open position to let fluid residues escape.
- ▶ Use a vessel to collect any fluid residues and properly dispose of them.

Commissioning/Decommissioning and Disassembly

⚠ WARNING

Risk of injury due to improper commissioning/decommissioning and disassembly!

Improper commissioning/decommissioning and disassembly may cause severe injury or death.

- ▶ Only deploy qualified personnel with appropriate personal protective equipment (PPE) and suitable work tools.
↳ See Sections 2.2 to 2.5.
- ▶ Ensure that unauthorized persons do not have any access to the ARGUS ball valve.
- ▶ Use appropriate safety measures in the workplace to ensure that parts cannot fall off.

NOTICE

Risk of property damage due to improper commissioning/decommissioning and disassembly!

Improper commissioning/decommissioning and disassembly may cause property damage.

- ▶ Only deploy qualified personnel with appropriate personal protective equipment (PPE) and suitable work tools.
↳ See Sections 2.2 to 2.5.
- ▶ Ensure that unauthorized persons do not have any access to the ARGUS ball valve.
- ▶ Use appropriate safety measures in the workplace to ensure that parts cannot fall off.

NOTICE

Risk of property damage due to flushing!

Pressure from flushing may damage the sealing elements.

- ▶ Operate the ARGUS ball valve in the fully open or fully closed (90°) position.
- ▶ After flushing, check the tightness of the flange connections.
- ▶ If necessary, retighten the screws of the flange connection.

NOTICE

Risk of environmental pollution due to fluid residues!

Fluid residues may harm the environment.

- ▶ Operate the ARGUS ball valve several times so that fluid residues and trapped pressure can escape.
- ▶ Use a vessel to collect any fluid residues and properly dispose of them.

Maintenance/Troubleshooting

▲ WARNING

Risk of injury due to improper maintenance/repair works!

Improper maintenance/repair works may cause severe injury or death.

- ▶ Only deploy qualified personnel with appropriate personal protective equipment (PPE) and suitable work tools.
↳ See Sections 2.2 to 2.5.
- ▶ Ensure that unauthorized persons do not have any access to the ARGUS ball valve.
- ▶ Observe the maximum permissible tightening torque of the stuffing box:
↳ See Annex D: Max. Permissible Screw Tightening Torques for Stuffing Box.
- ▶ Only use original spare parts provided by Flowserve Flow Control GmbH.
- ▶ Provide all necessary and appropriate tools and equipment for the maintenance/repair works.
- ▶ Use appropriate safety measures in the workplace to ensure that parts cannot fall off.
- ▶ Do not attempt to carry out repair/maintenance works on the ARGUS ball valve while in operation or under pressure.
- ▶ Contact the *Quick Response Center (QRC)* at Flowserve Flow Control GmbH for support if any repairs have to be carried out.

NOTICE

Risk of property damage due to improper maintenance/repair works!

Improper maintenance/repair works may cause property damage.

- ▶ Only deploy qualified personnel with appropriate personal protective equipment (PPE) and suitable work tools.
↳ See Sections 2.2 to 2.5.
- ▶ Ensure that unauthorized persons do not have any access to the ARGUS ball valve.
- ▶ Observe the maximum permissible tightening torque of the stuffing box:
↳ See Annex D: Max. Permissible Screw Tightening Torques for Stuffing Box.
- ▶ Only use original spare parts provided by Flowserve Flow Control GmbH.
- ▶ Provide all necessary and appropriate tools and equipment for the maintenance/repair works.
- ▶ Use appropriate safety measures in the workplace to ensure that parts cannot fall off.
- ▶ Do not attempt to carry out repair/maintenance works on the ARGUS ball valve while in operation or under pressure.
- ▶ Contact the *Quick Response Center (QRC)* at Flowserve Flow Control GmbH for support if any repairs have to be carried out.

NOTICE**Risk of environmental pollution due to fluid residues!**

Fluid residues may harm the environment.

- ▶ Operate the ARGUS ball valve several times so that fluid residues and trapped pressure can escape.
- ▶ Use a vessel to collect any fluid residues and properly dispose of them.

Storage**▲WARNING****Risk of injury due to improper storage!**

Improper storage may cause severe injury or death.

- ▶ Only deploy qualified personnel with appropriate personal protective equipment (PPE) and suitable work tools.
 - ↳ See Sections 2.2 to 2.5.
- ▶ Ensure that unauthorized persons do not have any access to the ARGUS ball valve.

NOTICE**Risk of property damage due to improper storage!**

Improper storage may cause property damage.

- ▶ Only deploy qualified personnel with appropriate personal protective equipment (PPE) and suitable work tools.
 - ↳ See Sections 2.2 to 2.5.
- ▶ Ensure that unauthorized persons do not have any access to the ARGUS ball valve.
- ▶ Ensure that the ARGUS ball valve is in a fully open position.

Packaging**▲WARNING****Risk of injury due to improper packaging!**

Improper packaging may cause severe injury.

- ▶ Only deploy qualified personnel with appropriate personal protective equipment (PPE) and suitable work tools.
 - ↳ See Sections 2.2 to 2.5.
- ▶ Ensure that unauthorized persons do not have any access to the ARGUS ball valve.

NOTICE

Risk of property damage due to improper packaging!

Improper packaging may cause property damage.

- ▶ Only deploy qualified personnel with appropriate personal protective equipment (PPE) and suitable work tools.
↳ See Sections 2.2 to 2.5.
- ▶ Ensure that unauthorized persons do not have any access to the ARGUS ball valve.
- ▶ Ensure that the ARGUS ball valve is in open position.

Transport

⚠ WARNING NOTICE

Danger of injury and material damage due to improper transport work!

Improper transport work can lead to severe injuries and material damage.

- ▶ Only deploy qualified personnel with appropriate personal protective equipment (PPE) and suitable work tools.
↳ See Sections 2.2 to 2.5.
- ▶ Make sure that no unauthorised persons have access to the ARGUS ball valve.
- ▶ Secure the ARGUS ball valve against turning and tipping.
- ▶ Properly attach slings to the ARGUS ball valve.
- ▶ If the lifting gear is only attached to the ARGUS ball valve, never lift the entire unit of ball valve and pneumatic actuator.
- ▶ Protect the ARGUS ball valve against damage with a suitable transport protection (e.g. a packing blanket).
- ▶ Observe all transport securing regulations.

2.2 Responsibility of the Owner Company

ARGUS ball valves are frequently used as safety-relevant components in industrial plants and pipeline systems. The owner company is responsible for the intended use or intended operation of the ARGUS ball valve and all the necessary work during the Pneumatic Actuator's life cycle. They will take all the necessary preventive safety measures to protect the personnel and the environment.

The owner company is responsible for taking the following preventive safety measures:

- All applicable laws, technical safety regulations and standards, rules for avoiding accidents and protecting the environment as well as company regulations shall be observed and enforced.
- Correct use of the ARGUS ball valve shall be ensured.
- The operating conditions and limits of the ARGUS ball valve shall be continuously monitored and all risks ensuing from operation of the ARGUS ball valve shall be eliminated.
- Only personnel qualified for the necessary work in the life cycle of the ARGUS ball valve shall be deployed.

- The personnel shall be provided with extensive personal protective equipment (PPE) and suitable tools.
- A risk assessment of the company premises on which the ARGUS ball valves are operated shall be carried out.
- Company-specific work instructions shall be compiled for operation of the ARGUS ball valve.
- It shall be continuously monitored that the personnel have read and understood all the pertinent instructions and these instructions.
- The personnel shall be kept up to date with the latest knowledge by regular training courses.



2.3 Qualified Personnel



Qualified personnel are authorised by an individual who is responsible for the operational safety of the industrial plant or the pipeline system. He/she is empowered to perform all the necessary activities within the scope of his/her experience, knowledge of all applicable laws, technical safety regulations and standards, rules for avoiding accidents and protecting the environment as well as company regulations and operating conditions. Qualified personnel are capable of recognising and avoiding dangers. The owner company shall ensure that only qualified personnel are deployed for the necessary work within the ARGUS ball valve life cycle.

2.4 Personal Protective Equipment

It is the owner company's responsibility to provide the operating personnel with high-quality personal protective equipment (PPE). This personal protective equipment must also be suitable for work on the ARGUS ball valve within the scope of the life cycle. The following personal protective equipment must be provided by the owner company:

Table 3: Personal protective equipment

Personal Protective Equipment	
	Protective helmet
	Protective goggles
	Protective clothing

Personal Protective Equipment	
	Protective gloves
	Protective shoes
	Protective respiratory mask

2.5 Personnel Qualification

Any personnel of the operating company that works with the ARGUS ball valve must have appropriate knowledge and skills and fulfill the following conditions:

- Sufficient qualification and personal suitability for the respective activity.
- Successfully completed user training for supervised or unsupervised work with the ARGUS ball valve.
- Knowledge of the personal protective equipment (PPE) and the way this equipment functions.
- Knowledge of these instructions, particularly of safety messages and sections relevant to the activities to be performed.
- Knowledge of fundamental regulations regarding health and safety and accident prevention.

2.6 Target Groups

These instructions addresses the following target groups:

2.6.1 Management of the Operating Company

The operating company's management carries out the compliance and organizational management activities and can be held responsible for their decisions.

2.6.2 Specialist Staff

Thanks to their completed specialist training, experience and knowledge of the relevant specifications and appropriate working equipment, specialist staff are able to perform the task assigned to them and recognize and eliminate any possible work-related dangers by themselves.

2.6.3 Trained Persons

Trained persons have received training provided by the operating company about the tasks they are to perform and work-related dangers.

2.6.4 Working Activities of the Target Groups

The table below contains work activities assigned to the target groups.

	<p><i>In order to prevent personal injury and/or property damage, ensure that only suitably qualified target groups are allowed to perform the work activities specified in the table below.</i></p>
-----------------------------------------------------------------------------------	-------------------------------------------------------------------------------------------------------------------------------------------------------------------------------------------------------------

Table 4: Target groups with assigned work activities

Target Groups	Work Activities
Management and executives of the operating company	<ul style="list-style-type: none"> ■ Compliance and organizational management (this includes initially reading and observing these instructions before personnel do) ■ Creation of training materials and conducting of training courses
Specialist staff	<ul style="list-style-type: none"> ■ Installation ■ Commissioning/decommissioning ■ Maintenance ■ Repairs (fault rectification) ■ Returns and disposal ■ Other kind of related work activities
Trained persons	<ul style="list-style-type: none"> ■ Unpacking ■ Packaging ■ Transportation ■ Storage ■ Other kind of related work activities

2.7 Notes on Product Warranty

Any non-intended use of the ARGUS ball valve may compromise its function. This leads to invalidation of any product warranty claims!



Note that the operating company shall be liable in the following cases:



- The ARGUS ball valve is operated in a manner which is not consistent with these instructions, particularly safety instructions, handling instructions and Section 2.8 Intended Use.
- Personnel operate the ARGUS ball valve who are not sufficiently qualified to carry out their respective activities.
- No original spare parts or accessories of Flowserve Flow Control GmbH are used.
- Unauthorized changes are made to the ARGUS ball valve.

2.8 Intended Use

The ARGUS ball valve is used as a shut-off device within its operating parameters/limits appropriate for the application, e.g., in piping or on containers in the areas of processing, transport and treatment of liquids, gases and solid-containing fluids. It is either operated manually or its function is automated using an actuator and the corresponding control system.

	<p><i>In order to prevent personal injury and/or property damage, ensure that the operating parameters on the nameplate and the design of the ARGUS ball valve match the specified application.</i></p> <p><i>⚡ See Section 1.9 Nameplate.</i></p> <p><i>Observe all labels on the ARGUS ball valve and keep them in a legible condition.</i></p> <p><i>If necessary, immediately replace any damaged and/or illegible labels.</i></p>
-----------------------------------------------------------------------------------	--------------------------------------------------------------------------------------------------------------------------------------------------------------------------------------------------------------------------------------------------------------------------------------------------------------------------------------------------------------------------------------------------------------------------------------------------------------------

ARGUS ball valves are generally suitable for operation in potentially explosive atmospheres. When used as intended, the ARGUS ball valves do not have their own potential sources of ignition and are therefore not "equipment" as defined by Article 1 of Directive 2014/34/EU ("ATEX Directive").

	<div style="background-color: red; color: white; padding: 5px; text-align: center; font-weight: bold; font-size: 1.2em;">  DANGER </div> <p>Risk of injury due to "Ex Area"!</p> <p>The explosion of an explosive atmosphere ("Ex Area") may cause severe injury or death.</p> <ul style="list-style-type: none"> ▶ Observe the intended use of the ARGUS ball valve. ▶ Observe the specific limit values applicable to the hazardous area. ▶ Observe the permissible fluid temperature and valve surface temperature. ▶ Only assign sufficiently qualified personnel to do work in potentially explosive atmospheres. ▶ Only use appropriate safe accessory components.
-------------------------------------------------------------------------------------	------------------------------------------------------------------------------------------------------------------------------------------------------------------------------------------------------------------------------------------------------------------------------------------------------------------------------------------------------------------------------------------------------------------------------------------------------------------------------------------------------------------------------------------------------------------------------------------------------------------------------------------------------------------------------------------------------------------------------------------------------------------------------------------------------------------------------

2.9 Non-intended Use

A non-intended use (only reasonably foreseeable misuse) is present in the following cases:

- The ARGUS ball valve is operated as a control valve.
- The ARGUS ball valve is operated outside its operating parameters/limits stated on the ARGUS ball valve nameplate.
- The ARGUS ball valve is installed, commissioned, maintained, repaired or worked on in any way that is not in compliance with these instructions.
- The ARGUS ball valve is operated without regard to the labels, such as arrows designating the installation orientation, warning signs, etc.
- The ARGUS ball valve is modified or used with spare parts not supplied by Flowserve Flow Control GmbH.

- The ARGUS ball valve is operated without having successfully passed all inspection acceptance criteria.
 - The ARGUS ball valve is operated in a partially assembled condition.
- i** If there is any doubt as to the suitability of the ARGUS ball valve for the application intended, contact the *Quick Response Center (QRC)* at Flowserve Flow Control GmbH for advice, quoting the serial number or article number of the ARGUS ball valve as stated on the nameplate.
- i** If the application conditions change (e. g., fluid, temperature or pressures) contact the *Quick Response Center (QRC)* at Flowserve Flow Control GmbH for support before putting the ARGUS ball valve in operation again.

2.10 General Sources of Danger/Residual Risks

This section points out general sources of danger/residual risks that exist during intended and non-intended use (only reasonably foreseeable misuse).

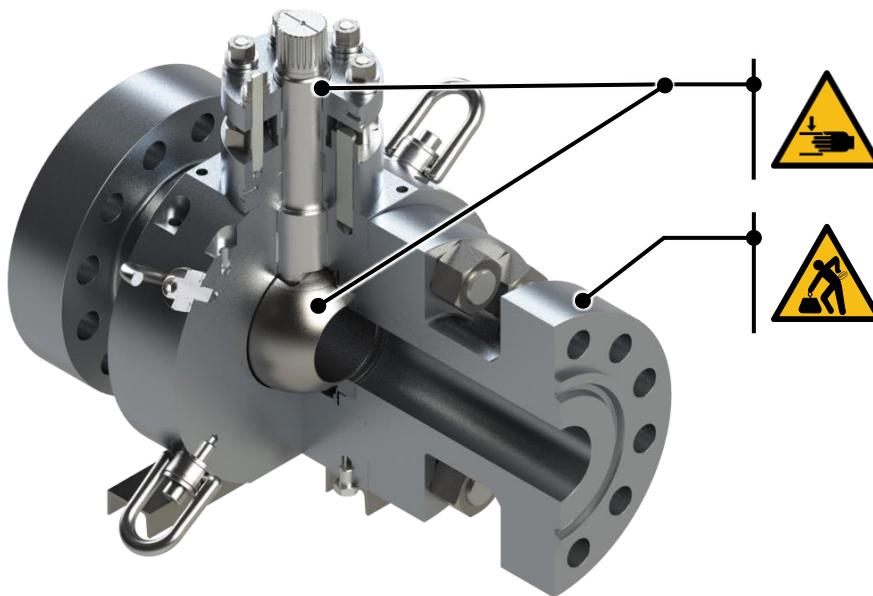



Figure 2: General sources of danger/residual risks on a ball valve

- i** This figure shows the main components of a ball valve to illustrate general sources of danger. The delivered ball valve may be a different model.

	<p>⚠ WARNING</p> <p>Risk of injury due to ball valve parts in motion!</p> <p>A ball valve wrench and ball which are in motion may cause crushing and/or amputate limbs.</p> <ul style="list-style-type: none"> ▶ Do not reach between the ball valve wrench and the ball valve guide washer. ▶ Do not reach into the bore of the ARGUS ball valve. ▶ Wear appropriate safety gloves.
--	-------------------------------------------------------------------------------------------------------------------------------------------------------------------------------------------------------------------------------------------------------------------------------------------------------------------------------------------------------------------------------------------------------------------------------------

	<p>⚠ WARNING</p> <p>Risk of injury due to a heavy ARGUS ball valve (≥ 15 kg)!</p> <p>A heavy ARGUS ball valve (≥ 15 kg) can cause back injuries when lifted without suitable lifting gear and slings.</p> <ul style="list-style-type: none"> ▶ Lift the ARGUS ball valve only in accordance with the operator's work instructions, industry standards and current legislation. ▶ Before lifting the ARGUS ball valve, first find out the approximate ball valve weight. ▶ Only lift the ARGUS ball valve with ≥ 15 kg with suitable lifting gear and slings. ▶ Always wear an appropriate personal protective equipment (PPE).
-----------------------------------------------------------------------------------	----------------------------------------------------------------------------------------------------------------------------------------------------------------------------------------------------------------------------------------------------------------------------------------------------------------------------------------------------------------------------------------------------------------------------------------------------------------------------------------------------------------------------------------------------------------------------------------------------------------------------------------------------------------------------------------

Furthermore, in case of a non-intended use (only reasonably foreseeable misuse) the following may occur:

- Failure of the ARGUS ball valve's primary functions.
- Damage to the industrial plant or piping system.
- Failure of required maintenance and repair methods.
- General risk of injury to personnel.
- Environment pollution caused by substances leaking from the ARGUS ball valve.

3 Product Description

3.1 General Product Description

The ARGUS ball valve has many innovative design features that represent the highest standards in valve technology.

The ARGUS ball valve FK and HK series are used as bubble-tight shut-off devices or shut-off valves in piping systems and containers used for processing, handling and transporting liquid or gaseous substances and solid materials.

ARGUS ball valves are composed of a body with a recess for a cylindrical perforated ball for rough flow control. The ball is either trunnion-mounted or floating.

Depending on the size, the ARGUS ball valves can be opened and closed manually with a ball valve wrench, a handwheel (with or without gearbox) or automatically by a hydraulic, pneumatic or electric actuator.

The ARGUS ball valve is open when the hole of the ARGUS ball valve is in line with the flow and closed when it is turned by 90 degrees. The wrench lies flat in alignment with the flow when open, and is perpendicular to it when closed, allowing easy visual confirmation of the valve's status.

ARGUS ball valves are durable, perform reliably after many cycles, and close securely even after long periods of non-use.

ARGUS ball valves are used for various applications in the following industries:

- Energy industry (e.g. oil, gas, nuclear and coal industry)
- Chemical and petrochemical industry
- Defense industry
- Pharmaceutical industry
- Research industry (e.g. research centers)

3.2 Design Features

The ARGUS ball valves FK and HK series can feature the following major construction/design characteristics:

- Two-piece/three-piece split body design with flanged connection
- Soft or metal ball seal (soft or metal ball seated/sealing)
- Trunnion-mounted ball
- Floating ball
- Anti-blow-out and anti-static stem
- Spring supported ball sealing (up to DN 300) with cavity pressure relief
- Seat area supported by coil springs (from DN 350) with cavity pressure relief
- Long life double stem sealing system
- Body design in compliance with EU Pressure Equipment Directive (PED), AD 2000, EN 12516 and EN 1092-1
- Body design in compliance with API 6D or API 608 or ASME B16.34, B16.5, B16.47, B16.10
- Sealing design compliance in accordance with EN ISO 15848 fugitive emissions requirements and TA-Luft (VDI 2440)

- Fire safe compliance in accordance with EN ISO 10497 and API 607
- Connecting plate design in accordance with EN ISO 5211 for easy assembly with actuators
- Sizes available from DN 15 (1/2") to DN 900 (36") with full or reduced bore
- Supported pressure classes from PN 10 to PN 250 (ASME Classes 150 to 2500)
- Standard temperature range from –50 °C to +400 °C (ARGUS ball valves with special features excluded)



Note that the actual design features of the ARGUS ball valve are specified in the delivery documents.

3.3 Scope of Delivery

The scope of delivery normally includes the following components:

- ARGUS ball valve (usually operated in open position)
- Wrench, wrench head with tube or handwheel (only for ball valves that are intended for manual operation)
- Protective caps
- Instructions including the EU Declaration of Conformity and Incorporation
- Order related documents (e.g., material certifications)
- Documents required by law



After goods receipt, check whether the delivery corresponds to the information on the delivery note. Report any deviations immediately to the forwarding agent and Flowserve Flow Control GmbH.

4 Consignment Receipt

4.1 Safety Messages



***In order to prevent personal injury and/or property damage, ensure that verification and unpacking work is only carried out by qualified personnel with appropriate personal protective equipment (PPE) and suitable work tools.
☞ See Chapter 2 Safety Information.***

4.2 Checking the Consignment Receipt for Completeness

1. Immediately upon receipt of the ARGUS ball valve check it against the delivery document (delivery note) for completeness.
 - ① A delivery document (delivery note) is enclosed with each delivery.
The details on the nameplate of the ARGUS ball valve allow clear identification and must correspond with the details on the delivery document (delivery note).
 2. Check the ARGUS ball valve for transportation damage.
 3. Immediately report any missing parts and/or damage to the transport agent and to Flowserve Flow Control GmbH.
 - ① Flowserve Flow Control GmbH must receive any claims in writing within one month of receipt of the ARGUS ball valve.
Note that Flowserve Flow Control GmbH cannot accept later claims.
- ✓ The procedure for consignment receipt is now complete.

4.3 Unpacking the ARGUS Ball Valve

1. Open the packaging.
 2. Loosen and remove all load securing material.
 3. Safely lift the ARGUS ball valve out of the packaging.
☞ See Chapter 12 Transportation.
 4. Dismantle or break down the packaging.
 5. Properly dispose any unneeded packaging and load securing material.
☞ See Chapter 13 Disposal and Recycling.
 6. Safely transport the ARGUS ball valve to its place of operation.
☞ See Chapter 12 Transportation.
- ✓ Unpacking the ARGUS ball valve is now complete.

5 Installation

5.1 Safety Messages

	<p><i>In order to prevent personal injury and/or property damage, ensure that installation work is only carried out by qualified personnel with appropriate personal protective equipment (PPE) and suitable work tools.</i></p> <p><i>🔗 See Chapter 2 Safety Information.</i></p>
-----------------------------------------------------------------------------------	------------------------------------------------------------------------------------------------------------------------------------------------------------------------------------------------------------------------------------------------------------------------------------

	<p>⚠️ WARNING</p> <p>Risk of injury due to welding procedures on pressurized piping!</p> <p>Welding procedures on pressurized piping may cause severe injury or death.</p> <ul style="list-style-type: none"> ▶ Observe local welding regulations, provisions, instructions, and specifications as well as specific safety requirements when welding. ▶ Ensure that welding is only carried out by qualified personnel with appropriate protective equipment. ▶ Ensure that no welding is carried out on pressurized piping.
-----------------------------------------------------------------------------------	-----------------------------------------------------------------------------------------------------------------------------------------------------------------------------------------------------------------------------------------------------------------------------------------------------------------------------------------------------------------------------------------------------------------------------------------------------------------------------------------------------------------------------------------------------------------------------

	<p>⚠️ WARNING</p> <p>Risk of injury due to incorrect ball valve installation!</p> <p>In case of incorrect ball valve installation (installation direction for unidirectional ball valves does not correspond to the specified flow direction or pressure direction), leakage of the ball valve can lead to serious injury or death.</p> <ul style="list-style-type: none"> ▶ Install the ARGUS ball valve according to the specified flow or pressure direction. ▶ Note the following preparations for the flange and welding installation.
-------------------------------------------------------------------------------------	-----------------------------------------------------------------------------------------------------------------------------------------------------------------------------------------------------------------------------------------------------------------------------------------------------------------------------------------------------------------------------------------------------------------------------------------------------------------------------------------------------------------------------------------------------------------------------------

<p>NOTICE</p>	
<p>Risk of property damage due to high temperature!</p> <p>In the case of short welding ends, high temperature from welding works may cause damage to the soft seal.</p> <ul style="list-style-type: none"> ▶ Observe the procedures in the following embedded safety messages. 	

NOTICE

Risk of property damage due to incorrect ball valve installation

In case of incorrect ball valve installation (installation direction for unidirectional ball valves does not correspond to the specified flow or pressure direction), the ball valve may leak.

- ▶ Install the ARGUS ball valve according to the specified flow or pressure direction.
- ▶ Note the following preparations for the flange and welding installation.

5.2 Preparing the Flange and Welded Installation

Observe the following safety measures before installing the ARGUS ball valve:

- Ensure that the installation direction for an unidirectional ARGUS ball valve corresponds to the specified flow direction or pressure direction.
In the case of an ARGUS ball valve with a wrench, the valve key should point in the flow direction.
- Ensure that the piping is strong enough to safely bear the ARGUS ball valve and its accessories.
Note: The total weight of the ARGUS ball valve including actuator and control modules is specified in the position parts list and assembly drawing.
These documents are available on request, indicating the order and item number.
- Before installing the ARGUS ball valve, ensure that the piping is clean and free of any fluids or other substances.
- Make sure there is sufficient clearance above and to the side of the ARGUS ball valve and attachments to ensure maintenance and/or repair work without risk.
- If the ARGUS ball valve is intended for regular manual operation, provide a standing area for the operator so he or she can safely apply the necessary forces.

5.3 Installing the ARGUS Ball Valve via a Flange Connection

1. Transport the ARGUS ball valve to the installation site using lifting devices suitable and slings for the weight and the size of the ARGUS ball valve.
↳ See Chapter 12 Transportation.

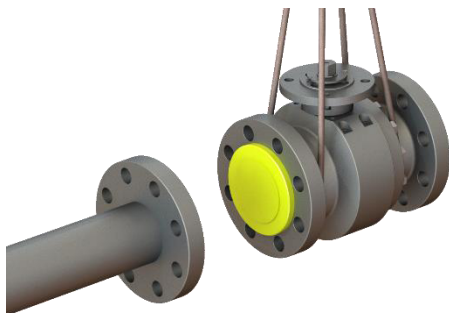

2. Remove the protective caps.

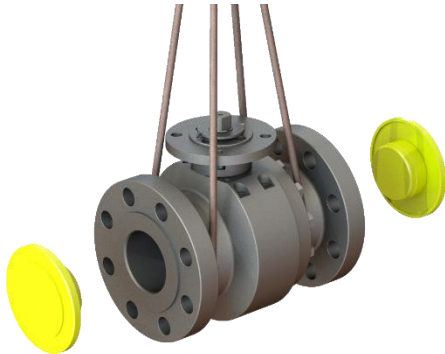

3. Clean the piping ends, flange connections and sealing surfaces.

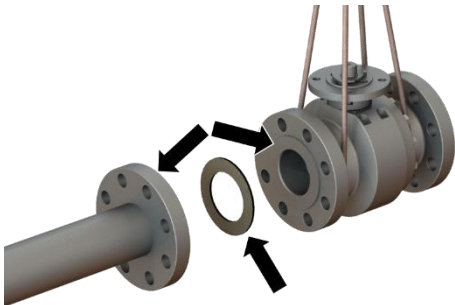

4. Assembling the ARGUS ball valve on the first flange:

- ▶ Connect the ARGUS ball valve on the first flange using some bolts and position the seal.
- ▶ Ensure the correct position of the ARGUS ball valve and seal.

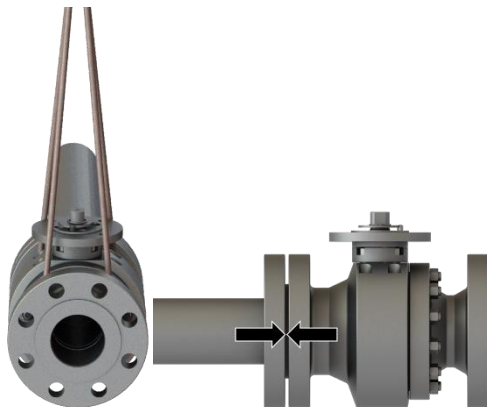

5. Tighten the bolts crosswise.

Use the correct tightening torques specified by the industrial plant operator.

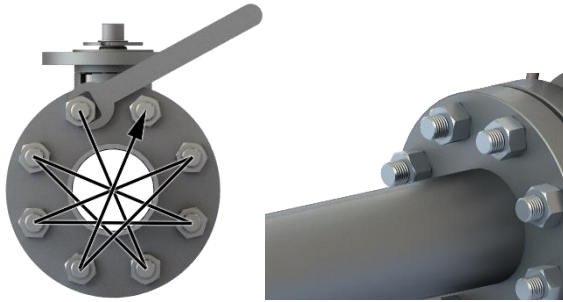

6. Assemble the ARGUS ball valve to the second flange:
Follow the same procedure as for the first flange.

7. Check the seal after the flange connection has been completed.

✓ Installation of the ARGUS ball valve is now complete.

5.4 Installing the ARGUS Ball Valve via a Welded Connection

1. Transport the ARGUS ball valve to the assembly location using lifting devices and slings suitable for the weight and the size of the ARGUS ball valve.
↳ See Chapter 12 Transportation.

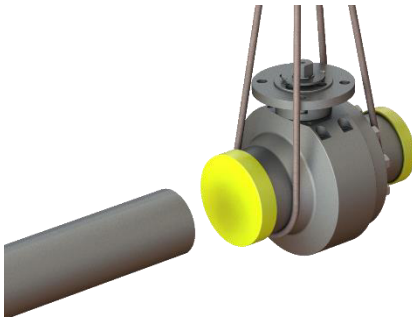

2. Remove the protective caps.

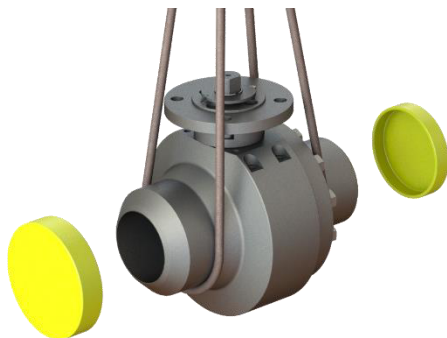

3. Clean the piping connection and the welding ends of the ARGUS ball valve.

4. Remove paint and rust in the area of the welded joints so there is a clean metal surface.

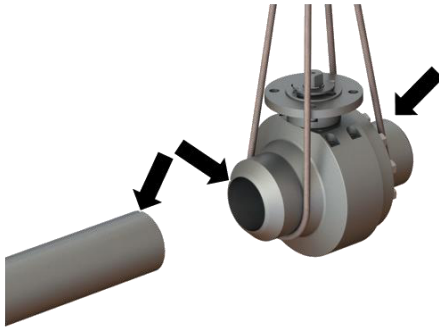

NOTICE

Risk of property damage due to excessive heat development!

In the case of short welding ends, excessive heat development from welding works may cause damage to the soft seal.

- ▶ If possible, put a wet towel over the ARGUS ball valve.
- ▶ Monitor the temperature of the valve body in the seat area by using the temperature-sensing strips (shown here in blue) during welding.
The maximum permitted temperature is: 100 °C

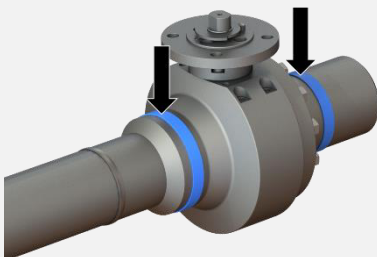

(position of the temperature-sensing strips)

- ▶ Continuously monitor the temperature strip during welding.
- ▶ In case of a reaction (color change), interrupt the welding.
- ▶ Let the valve body cool down.

5. Weld the ARGUS ball valve to the first welding end.

- ⓘ Ensure correct placement and correct alignment of the ARGUS ball valve with the piping connection.

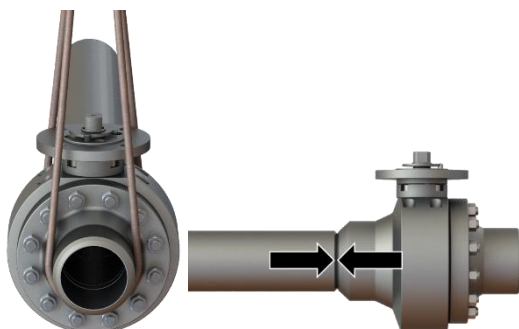

NOTICE

Risk of property damage due to excessive heat development!

In case of short welding ends, excessive heat development may cause damage to soft seal.

- ▶ If possible, put a wet towel over the ARGUS ball valve.
- ▶ Monitor the temperature of the valve body in the seat area by using the temperature-sensing strips during welding.
The maximum permitted temperature is: 100 °C

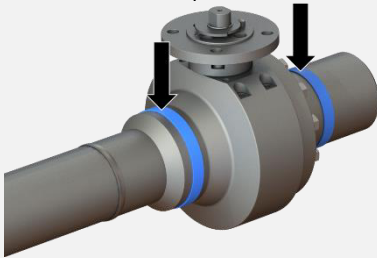

(position of the temperature-sensing strips)

- ▶ Continuously monitor the measuring strip during welding.
- ▶ In case of a reaction (color change), interrupt the welding.
- ▶ Let the valve body cool down.

6. Weld the ARGUS ball valve to the second welding end.

- ⓘ Ensure correct placement and correct alignment of the ARGUS ball valve with the piping connection.



- ✓ Installation of the ARGUS ball valve is now complete.

5.5 Installing/Aligning the Actuator

Actuators are usually installed above the ARGUS ball valve if the stem of the ball valve is in a vertical position. Other types of installation are possible depending on assessment of the specific application conditions.

- ⓘ In case of heavy and/or asymmetrical actuators or with units which are not installed vertically, critical bending or torsional forces can occur, especially on extended stems, for example, those equipped with a stuffing box. Have on-site support provided for installing the actuator.
In case of critical vibrations or impacts during operation, it is also useful to additionally support the actuator or provide shock absorption.

6 Commissioning

6.1 Safety Messages

	<p><i>In order to prevent personal injury and/or property damage, ensure that commissioning, flushing and pressure testing works are only carried out by qualified personnel with appropriate personal protective equipment (PPE) and suitable work tools.</i></p> <p>⚡ See Chapter 2 Safety Information.</p>
-----------------------------------------------------------------------------------	---------------------------------------------------------------------------------------------------------------------------------------------------------------------------------------------------------------------------------------------------------------------------------------------------------------

	<p>⚠ WARNING</p> <p>Risk of injury due to exceeded operating parameters/limits!</p> <p>Exceeded operating parameters/limits may cause severe injury or death.</p> <ul style="list-style-type: none"> ▶ Never exceed the operating parameters/limits of the ball valve stated on the nameplate.
-----------------------------------------------------------------------------------	-----------------------------------------------------------------------------------------------------------------------------------------------------------------------------------------------------------------------------------------------------------------------------------------------------------------------------

	<p>⚠ WARNING</p> <p>Risk of injury due to automated operation!</p> <p>In automated operation moving parts may cause severe injury or death.</p> <ul style="list-style-type: none"> ▶ Keep hands, hair and clothing away from all moving parts. ▶ Observe the instructions of the actuator.
-------------------------------------------------------------------------------------	----------------------------------------------------------------------------------------------------------------------------------------------------------------------------------------------------------------------------------------------------------------------------------------------------------------------------------

	<p>⚠ WARNING</p> <p>Risk of property damage due to flushing and/or pressure testing of the piping!</p> <p>Flushing pressure and/or a (hydrostatic) pressure testing may cause damages to sealing elements (e.g., at the stem and the stuffing box).</p> <ul style="list-style-type: none"> ▶ Never exceed the operating parameters/limits stated on the ball valve nameplate. ▶ Operate the ARGUS ball valve into fully open position. ▶ After flushing and/or the pressure testing, check the flange connections again. ▶ If necessary, retighten bolts on the flange connection according to the torque specifications of the plant operator.
-------------------------------------------------------------------------------------	---------------------------------------------------------------------------------------------------------------------------------------------------------------------------------------------------------------------------------------------------------------------------------------------------------------------------------------------------------------------------------------------------------------------------------------------------------------------------------------------------------------------------------------------------------------------------------------------------------------------------------------------------------------------------------------------------------

6.2 Requirements for Commissioning

Before commissioning and putting into service, ensure the following requirements:

- Flush the piping
- Test the pressure of the piping

6.3 Flushing and Pressure Testing of the Piping

⚠ WARNING

Risk of injury due to exceeded operating parameters/limits!

Exceeded operating parameters/limits may cause severe injury or death.

- ▶ Never exceed the operating parameters/limits of the ball valve stated on the nameplate.

1. Flush the pipeline to remove any fluid residue, dirt or other foreign particles
 2. Test the pressure of the piping to confirm the tightness and strength of the industrial plant section.
- ✓ Flushing and pressure testing of the piping are now complete.

6.4 Operating the ARGUS Ball Valve

The ARGUS ball valve can be operated manually or automatically by an actuator.

There are three operation positions:

- Open (the ARGUS ball valve opens by rotating to the left or counterclockwise)
- Closed (the ARGUS ball valve closes by rotating to the right or clockwise)
- Half-open (not intended for normal operation)

The ARGUS ball valve is open when the flat sides of a double-D operating spindle or the groove of a square operating spindle or toothed operating spindle are parallel to the direction of flow.

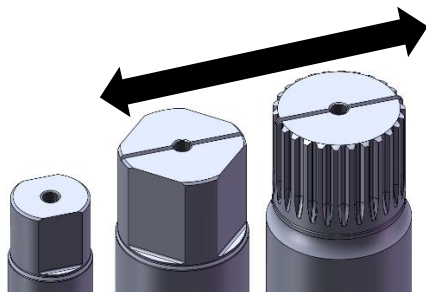

For safety reasons the position of the ARGUS ball valve is recognizable by the ball valve wrench.

6.4.1 Manually Operating the ARGUS Ball Valve to Open Position

1. Move the ball valve wrench parallel to the valve body/piping.



- ✓ The ARGUS ball valve is open.

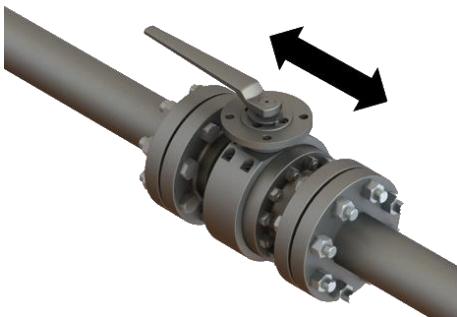

6.4.2 Manually Operating the ARGUS Ball Valve to Closed Position

1. Move the ball valve wrench crosswise (90°) to the valve body/piping.





- ✓ The ARGUS ball valve is closed.



7 Maintenance

7.1 Safety Messages

	<p><i>In order to prevent personal injury and/or property damage, ensure that maintenance work is only carried out by qualified personnel with appropriate personal protective equipment (PPE) and suitable work tools.</i></p> <p>🔗 See Chapter 2 Safety Information.</p>
-----------------------------------------------------------------------------------	----------------------------------------------------------------------------------------------------------------------------------------------------------------------------------------------------------------------------------------------------------------------------

	<p>⚠️ WARNING</p> <p>Risk of injury due to an automated ARGUS ball valve!</p> <p>Moving parts of an automated ARGUS ball valve may cause severe injury or death.</p> <ul style="list-style-type: none"> ▶ Keep hands, hair or clothing away from moving parts. ▶ Observe the instructions and their safety messages of the automated components.
-----------------------------------------------------------------------------------	----------------------------------------------------------------------------------------------------------------------------------------------------------------------------------------------------------------------------------------------------------------------------------------------------------------------------------------------------------------------------------------

	<p>⚠️ WARNING</p> <p>Risk of injury from fluid residues and trapped pressure!</p> <p>Fluid residue and trapped pressure can cause serious injury or death.</p> <ul style="list-style-type: none"> ▶ Operate the ARGUS ball valve several times so that fluid residues and trapped pressure can escape. ▶ Use a vessel to collect any fluid residues and properly dispose of them.
-------------------------------------------------------------------------------------	-------------------------------------------------------------------------------------------------------------------------------------------------------------------------------------------------------------------------------------------------------------------------------------------------------------------------------------------------------------------------------------------------------------------------

7.2 Required Spare Parts for Maintenance

Under particularly stressful operating conditions, wear and tear to the sealing elements of the ARGUS ball valve may occur after a certain period of time. In addition, very critical or severe service may require that components of the ARGUS ball valve be periodically renewed.



For maintenance works appropriate spare parts are required. Flowserve Flow Control GmbH provides repair sets or replacement kits for each ARGUS ball valve.

Clearly identify the ARGUS ball valve so Flowserve Flow Control GmbH can provide the corresponding repair sets or replacement kits.

This technical identification can be made either via the customer order documents (e.g. delivery bill or invoice) or via the information on the type plate.

7.3 Maintenance Schedule



The following inspections can be carried out in the installed state. As a rule, normal industrial plant operation does not have to be interrupted.

In case of any leakage, damage and/or incorrect condition:

↳ See Chapter 8 Troubleshooting Guide.

Table 5: Recommended maintenance inspections

No.	Inspection	Schedule/Cycles
1	Inspect the flange and welded connection for leakages.	Every 6 months
2	Inspect the ARGUS ball valve's seals for leaks and retighten the stuffing box nuts if present (↳ see Section 8.4 Tightening the Stuffing Box Nuts or Replacing the Stuffing Box Packing).	
3	Inspect the test connection (leakage detector at the stem seal) or the drain/safety plug (↳ see Sections 8.6 and 8.7) – if present – for leaks to the outside.	
4	Inspect the ARGUS ball valve for external damage.	
5	Clean the ARGUS ball valve and repaint if necessary.	
6	 Jerky running of the ball valve stem can indicate increased torque. With stem seals made of graphite jerky, running of the ball valve stem is possible without any defect.	
7	Check the actuator for fixed installation and proper function.	
8	Check all accessories for tight fit and proper function.	

8 Troubleshooting Guide

8.1 Safety Messages

	<p>In order to prevent personal injury and/or property damage, ensure that repair work is only carried out by qualified personnel with appropriate personal protective equipment (PPE) and suitable work tools.</p> <p>🔗 See Chapter 2 Safety Information.</p>
-----------------------------------------------------------------------------------	-----------------------------------------------------------------------------------------------------------------------------------------------------------------------------------------------------------------------------------------------------------------------

	<p>⚠️ WARNING</p> <p>Risk of injury due to repair work on the ARGUS ball valve during operation!</p> <p>Repair work on the ARGUS ball valve during operation and/or while under pressure may cause severe injury or death.</p> <ul style="list-style-type: none"> ▶ Do not attempt to repair the ARGUS ball valve while in operation and/or under pressure. ▶ Follow the procedures specified in the embedded safety messages below closely. ▶ Contact the <i>Quick Response Center (QRC)</i> at Flowserve Flow Control GmbH for support if any repairs have to be carried out.
-----------------------------------------------------------------------------------	--------------------------------------------------------------------------------------------------------------------------------------------------------------------------------------------------------------------------------------------------------------------------------------------------------------------------------------------------------------------------------------------------------------------------------------------------------------------------------------------------------------------------------------------------------------------------------------------------------------------------------

	<p>⚠️ WARNING</p> <p>Risk of injury due to repair welding or joint welding on the ARGUS ball valve!</p> <p>Due to possible non-metallic inclusions in the metal body of the ARGUS ball valve, repair or joint welding is very dangerous and can lead to serious injury or death.</p> <ul style="list-style-type: none"> ▶ Do not perform any repairs or joint welding. ▶ Contact the <i>Quick Response Center (QRC)</i> at Flowserve Flow Control GmbH for support if any repair or joint welding has to be carried out.
-------------------------------------------------------------------------------------	----------------------------------------------------------------------------------------------------------------------------------------------------------------------------------------------------------------------------------------------------------------------------------------------------------------------------------------------------------------------------------------------------------------------------------------------------------------------------------------------------------------------------------------------------------------

8.2 Required Spare Parts for Repair Works

- 

For repair works appropriate spare parts are required. Flowserve Flow Control GmbH provides repair sets or replacement kits for each ARGUS ball valve. Clearly identify the ARGUS ball valve so Flowserve Flow Control GmbH can provide the corresponding repair sets or replacement kits. This technical identification can be made either via the customer order documents (e.g. delivery bill or invoice) or via the information on the type plate.

8.3 Troubleshooting Table



Due to the large number of ARGUS ball valve variants, installed actuators and their use, it is not possible to refer to all types of problems, causes and remedies in the following troubleshooting table.

If problems occur, it is best to contact the *Quick Response Center (QRC)* at Flowserve Flow Control GmbH for the specific support services you require.

Table 6: Troubleshooting table

No.	Problem Description	Probable Causes	Corrective Action
1	External leakage	Stem seal or the stuffing box packing are worn out	Replace stem seal or stuffing box packing ↳ for this purpose contact the <i>Quick Response Center (QRC)</i> at Flowserve Flow Control GmbH
		Nuts at the stuffing box are loose (stem seal has settled)	Retighten stuffing box nuts ↳ see Section 8.4 Tightening the Stuffing Box Nuts or Replacing the Stuffing Box Packing.
		Body seal is worn out	Replace body seal ↳ for this purpose contact the <i>Quick Response Center (QRC)</i> at Flowserve Flow Control GmbH
		ARGUS ball valve incorrectly installed in the pipeline	Check the installation of the ball valve ↳ see Chapter 5 Installation
		The pipelines are not laid with low tension	Lay the pipelines tension-free
2	Leakage into the pipeline	Ball seal is worn out	Replace the ball seal → for this purpose contact the <i>Quick Response Center (QRC)</i> at Flowserve Flow Control GmbH
3	ARGUS ball valve is stiff	The inside of the ball valve is dirty	Clean the ball/ball valve → for this purpose contact the <i>Quick Response Center (QRC)</i> at Flowserve Flow Control GmbH

8.4 Tightening the Stuffing Box Nuts or Replacing the Stuffing Box Packing

For use at high temperatures (> 250 °C) ARGUS ball valves can be equipped with an extended stem and a stuffing box attachment. To eliminate a stem leakage of the ARGUS ball valve, the stuffing box nuts have to be retightened or the stuffing box packing have to be replaced.

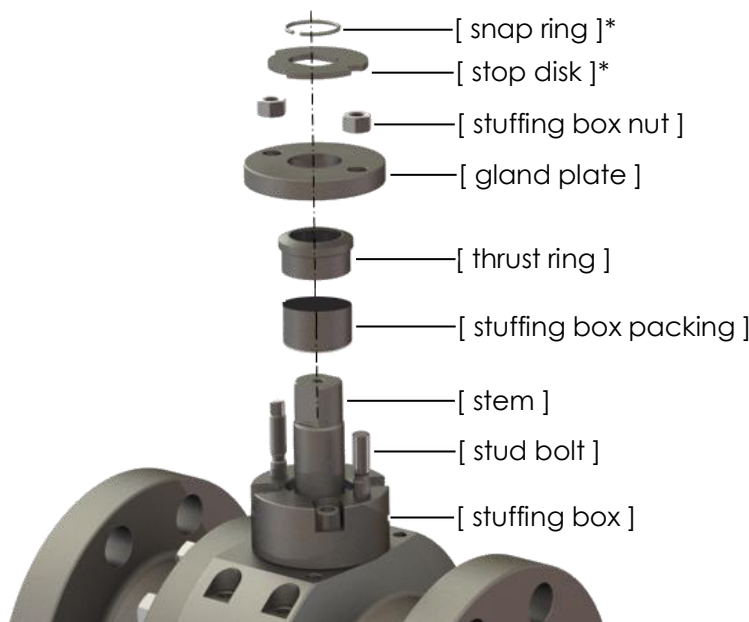

* not for all models

Figure 3: Components of the stuffing box attachment

8.4.1 Retightening the Stuffing Box Nuts

1. Tighten the stuffing box nuts evenly crosswise.

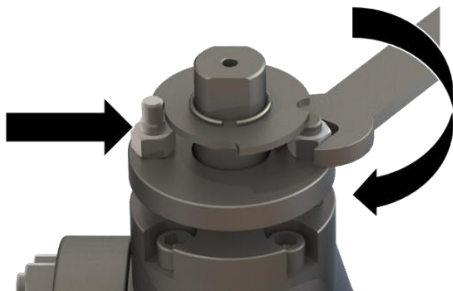

i Observe the recommended maximum torques for tightening the stuffing box nuts in Annex D: Max. Permissible Screw Tightening Torques for Stuffing Box.

⚠ WARNING

Risk of injury due to loose fastening nuts on the ball valve body!

Loose fastening nuts on the ball valve body can lead to serious injury or death.

- ▶ Do not loosen the fastening nuts.

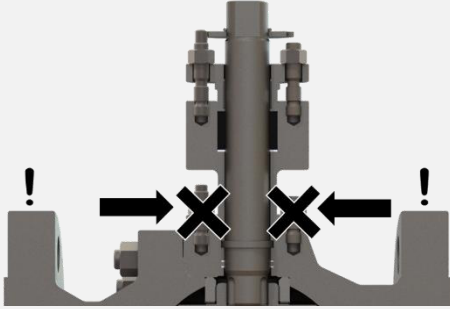

- ✓ Tightening of the stuffing box nuts is completed.

- ⓘ If you cannot eliminate a stem leakage of the ARGUS ball valve by tightening the stuffing box nuts, replace the stuffing box packing (see following section).

8.4.2 Replacing the Stuffing Box Packing

- ⓘ Flowserve Flow Control GmbH will provide replacement stuffing box packings and special tools (e.g. packing puller and setting bushing) if you specify the order number and position number of the ARGUS ball valve. You will find these numbers on the ball valve name plate.
Only use original spare parts from Flowserve Flow Control GmbH.

⚠ WARNING

Risk of injury from fluid residues, trapped pressure and high surface temperatures!

Fluid residue, trapped pressure and/or high surface temperatures can cause serious injury or death.

- ▶ Before replacing the stuffing box packing, operate the ARGUS ball valve several times so that fluid residues and trapped pressure can escape.
- ▶ Do not touch surfaces with high surface temperatures and let them cool down.
- ▶ Collect fluid residues with a collecting container and dispose of them properly and properly.



The ARGUS ball valve

- is out of service.
- is not under pressure (operate the ARGUS ball valve several times so that fluid residues and trapped pressure can escape).

1. Remove the snap ring and stop disk (if present).

⚠ WARNING

Danger of injury due to a pressurized stuffing box packing!

Components of the stuffing box can be ejected due to a pressurized stuffing box attachment.

- ▶ If the stuffing box packing is under pressure, do not unscrew nuts from the stud bolts.
- ▶ Allow the stuffing box packing to outgas for 24 hours with the gland plate loosened.

2. Loosen the nuts on the gland plate.
3. Allow the stuffing box packing to outgas for 24 hours with the gland plate loosened.
4. Unscrew the loosened nuts from the stud bolts.
5. Pull the gland plate and the thrust ring off the stem.
6. Slowly and carefully remove the old stuffing box packing with suitable tools (e.g. packing puller).
- ⓘ Take care not to damage the stem and/or the inside of the stuffing box when removing the stuffing box packing, as in this case the ARGUS ball valve may leak.
7. Insert a new stuffing box packing into the stuffing box.
- ⓘ Use a suitable setting bushing for this purpose.
8. Push the thrust ring into the stuffing box.
9. Place the gland plate on the stuffing box.
10. Tighten the stuffing box nuts evenly crosswise.

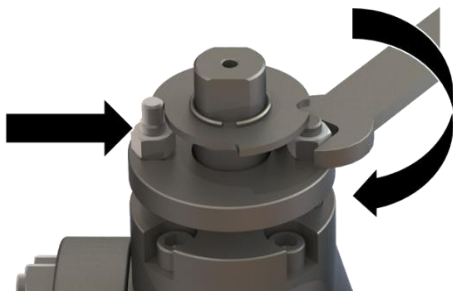

- ⓘ Observe the recommended maximum torques for tightening the stuffing box nuts in Annex D: Max. Permissible Screw Tightening Torques for Stuffing Box.

11. Attach the stop disk and snap ring.
- ✓ The replacement of the stuffing box packing is completed.

8.5 Replacing the Live Loading Stuffing Box Packing

In the course of time, stuffing box packings show signs of settling which make it necessary to retighten the stuffing box nuts. In order to maintain the minimum pressure permanently and to avoid a stem leakage, ARGUS ball valves can be equipped with a live loading stuffing

box packing (also called self-tightening stuffing box packing). The advantage of the live loading stuffing box packing is that the stuffing box packing is constantly retightened and therefore retightening of the stuffing box nuts is not necessary. A live loading stuffing box packing therefore extends the maintenance interval.

If a stem leakage occurs at the ARGUS ball valve despite live loading stuffing box packing, you have to retighten the stuffing box nuts or replace the stuffing box packing.

↳ See Section 8.4.

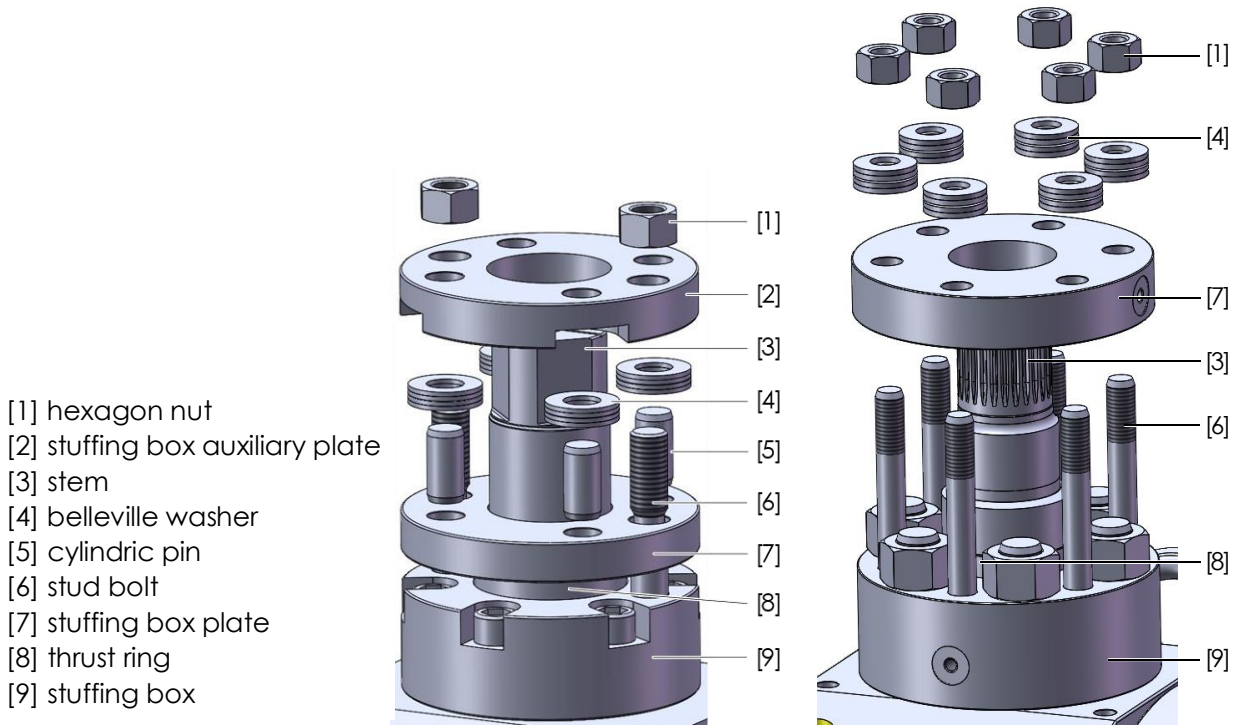

Figure 4: Stuffing box attachment variants with live loading stuffing box packing (disassembled)

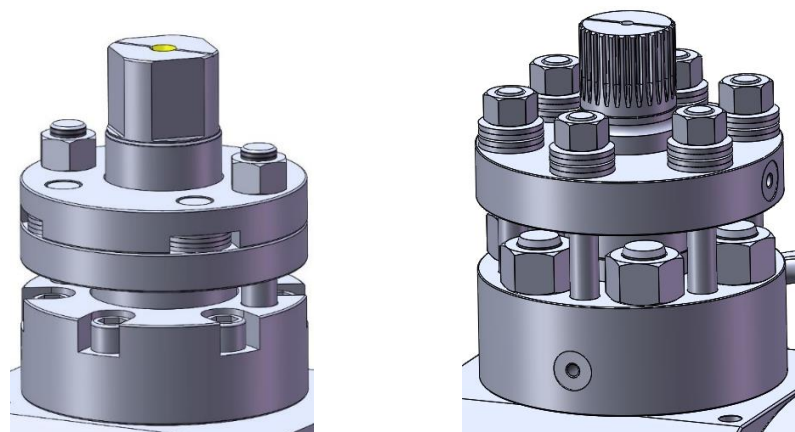



Figure 5: Stuffing box attachment variants with live loading stuffing box packing (assembled)

8.6 Draining the ARGUS Ball Valve with the Drain Plug (if present)

The drain plug on the bottom of the ARGUS ball valve body, as an optional feature, serves to drain off any fluid residues from the ball valve interior.

-  Note that the operation and use of the drain plug may vary depending on the type and manufacturer. Therefore the following instructions are intended to illustrate the use only as an example. Information on the exact operation and use of the drain plug can be found in the manufacturer's documentation.

⚠ WARNING

Risk of injury from fluid residues and trapped pressure!

Fluid residues and trapped pressure in the ARGUS ball valve can cause serious injury or death.

- ▶ Before removing and/or loosening the drain plug, operate the ARGUS ball valve several times so that fluid residues and trapped pressure can escape.
- ▶ Use a vessel to collect any fluid residues and dispose of them properly.

1. Place a catch basin under the plug orifice before draining.
2. Remove the drain plug to drain fluid residues.

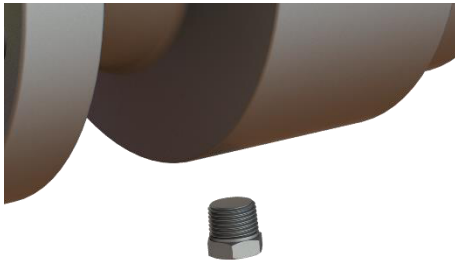

3. After draining properly, dispose of the fluid residues that have been collected.



4. Screw the drain plug to the upper part of the ball valve body.

✓ Draining is now complete.

8.7 Draining the ARGUS Ball Valve with the Safety Plug (if present)

The safety plug, also called the "captive drain plug" is designed to prevent unintended loss of the drain plug when draining fluid residues. The safety plug can also be closed again immediately when loosening – even if there is overpressure in the ARGUS ball valve.

-  Note that the operation and use of the safety plug may vary depending on the type and manufacturer. Consequently, the following instructions are intended to illustrate the use only as an example. Information on the exact operation and use of the safety plug can be found in the manufacturer's documentation.

8.7.1 Installing the Safety Plug

1. Screw the complete safety plug tightly into the tapped hole using a thread lock (e.g. Loctite).

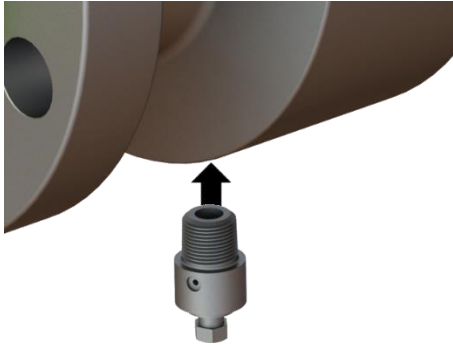

- ✓ Installation of the safety plug is now complete.

8.7.2 Opening the Safety Drain Plug

⚠ WARNING

Risk of injury from fluid residues and trapped pressure!

Fluid residues and trapped pressure in the ARGUS ball valve can cause serious injury or death.

- ▶ Do not place yourself in front of the outlet orifice.
- ▶ Keep a vessel nearby and collect any fluid residues.

1. Turn the safety plug head in the counterclockwise direction.

-  Note that the safety plug head may only be opened, not forcibly screwed out.



- ✓ The safety drain plug is open and the fluid residues can escape.

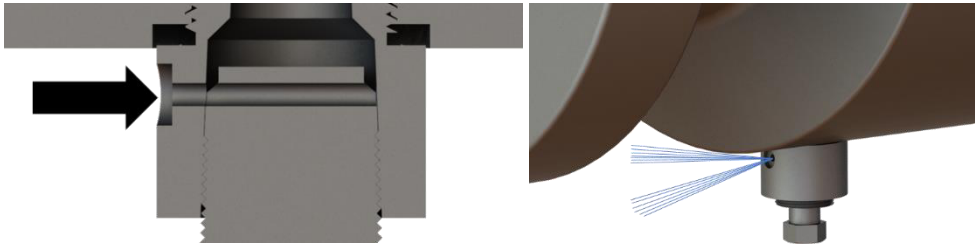

8.7.3 Closing the Safety Drain Plug

1. Turn the safety plug head in the clockwise direction.

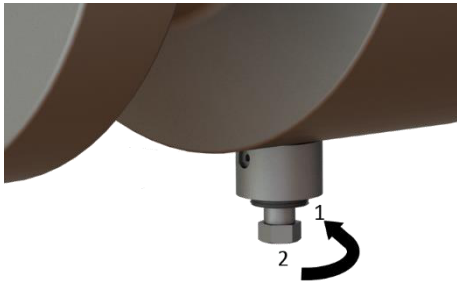

- ✓ The safety drain plug is now closed.

8.8 Returning the ARGUS Ball Valve for Repair

If the ARGUS ball valve cannot be repaired using the troubleshooting table above, return the ARGUS ball valve to Flowserve Flow Control GmbH for professional repair.

- i** Note that the ARGUS ball valve must be emptied, cleaned, and a preserving medium applied before being returned to Flowserve Flow Control GmbH. Flowserve Flow Control GmbH will only open and repair the ARGUS ball valve if the decontamination declaration form and safety data sheet are enclosed. Flowserve Flow Control GmbH will provide you with a decontamination declaration form and safety data sheet before return.

- 👉** The ARGUS ball valve to be returned must be

- Emptied
- Cleaned
- Preserved
- Free from fluid residues and trapped pressure

1. Properly pack the ARGUS ball valve for return.
👉 See Chapter 11 Packaging.
2. Send the completed and signed decontamination declaration form and the safety data sheet in advance to Flowserve Flow Control GmbH or attach the documents to the outside and clearly visible on the return of goods.

- i** The decontamination declaration form and safety data sheet must clearly confirm that the ARGUS ball valve does not pose any risk to persons or to the environment.

Flowserve Flow Control GmbH will accept a return only if the completed and bindingly signed decontamination declaration form and safety data sheet accompany the return.

3. Send the return to Flowserve Flow Control GmbH.
- ✓ The return of the ARGUS ball valve is completed.

9 Decommissioning and Disassembly

9.1 Safety Messages

	<p><i>In order to prevent personal injury and/or property damage, ensure that decommissioning work is only carried out by qualified personnel with appropriate personal protective equipment (PPE) and suitable work tools.</i></p> <p><i>☞ See Chapter 2 Safety Information.</i></p>
-----------------------------------------------------------------------------------	-----------------------------------------------------------------------------------------------------------------------------------------------------------------------------------------------------------------------------------------------------------------------------------------------------

	<p style="background-color: red; color: white; padding: 5px;">⚠ DANGER</p> <p>Risk of injury due to falling loads!</p> <p>Incorrect attachment of loads may cause severe injury or death.</p> <ul style="list-style-type: none"> ▶ Correctly attach the ARGUS ball valve and/or actuator. ☞ See Chapter 12 Transportation and the superior instructions VAIOM001028. ▶ Never stand under heavy load.
-----------------------------------------------------------------------------------	------------------------------------------------------------------------------------------------------------------------------------------------------------------------------------------------------------------------------------------------------------------------------------------------------------------------------------------------------------------------------------------------------------------------------------------------

	<p style="background-color: orange; color: black; padding: 5px;">⚠ WARNING</p> <p>Risk of injury due to fluid residues and trapped pressure!</p> <p>Fluid residue and trapped pressure can cause serious injury or death.</p> <ul style="list-style-type: none"> ▶ Never disassemble a pressurized ARGUS ball valve from the pipeline. ▶ Operate the ARGUS ball valve several times so that fluid residues and trapped pressure can escape. ▶ Use a vessel to collect any fluid residues and dispose of them properly. ▶ Follow the procedures specified in the embedded safety messages below closely.
-------------------------------------------------------------------------------------	-----------------------------------------------------------------------------------------------------------------------------------------------------------------------------------------------------------------------------------------------------------------------------------------------------------------------------------------------------------------------------------------------------------------------------------------------------------------------------------------------------------------------------------------------------------------------------------------------------------------------------------------------------------------

9.2 Decommissioning and Disassembly of the ARGUS Ball Valve

 Before decommissioning and disassembly, observe the following requirements:

- The specifications of the operating company for the decommissioning and disassembly are observed.
- The piping and the ARGUS ball valve are depressurized, free of fluid residues and have cooled down, so there is no risk of injury.

1. Decommission the affected piping system.
2. Operate the ARGUS ball valve several times so that fluid residues and trapped pressure can escape.

3. Flush the pipeline to remove any fluid residue, dirt or other foreign particles.
 4. Ensure that there are no fluid residues, dirt or other foreign particles in the pipeline.
 5. Disconnect the power supply to the actuator and to its control components.
 6. Disconnect the actuator and the control components from the ARGUS ball valve.
 7. Disassemble the ARGUS ball valve from the pipeline.
- ⓘ When disassembling the ARGUS ball valve, pay attention to the information given in chapter 12 Transportation.
- ✓ The decommissioning and disassembly are now complete.

10 Storage

10.1 Safety Messages

	<p>In order to prevent personal injury and/or property damage, ensure that storage work is only carried out by qualified personnel with appropriate personal protective equipment (PPE) and suitable work tools.</p> <p>🔗 See Chapter 2 Safety Information.</p>
-----------------------------------------------------------------------------------	------------------------------------------------------------------------------------------------------------------------------------------------------------------------------------------------------------------------------------------------------------------------

	<p style="background-color: red; color: white; padding: 5px;">⚠ DANGER</p> <p>Risk of injury due to falling loads!</p> <p>Incorrect attachment of loads may cause severe injury or death.</p> <ul style="list-style-type: none"> ▶ Correctly attach the ARGUS ball valve and/or actuator. 🔗 See Chapter 12 Transportation and the superior instructions VAIOM001028. ▶ Never stand under heavy load.
-----------------------------------------------------------------------------------	------------------------------------------------------------------------------------------------------------------------------------------------------------------------------------------------------------------------------------------------------------------------------------------------------------------------------------------------------------------------------------------------------------------------------------------------

<p style="background-color: blue; color: white; padding: 10px; font-size: 24px;">NOTICE</p>	<p>Risk of property damage due to incorrect storage!</p> <p>An incorrect storage of the ARGUS ball valve may cause property damage.</p> <ul style="list-style-type: none"> ▶ Follow the procedures in the section below closely.
----------------------------------------------------------------------------------------------------	--------------------------------------------------------------------------------------------------------------------------------------------------------------------------------------------------------------------------------------------------------

10.2 Storing the ARGUS Ball Valve

- 👉 Ensure that the following conditions apply:
The ARGUS ball valve
- Is disconnected from the piping
 - Is free from any fluid residues and trapped pressure (observe national regulations on disposal of hazardous waste)
 - Is in the open position (as supplied)
 - Is free from any dirt
 - Is dry
 - Has protective factory fitted caps (including Volatile Corrosion Inhibitor paper) attached
1. For an heavy ARGUS ball valve (≥ 15 kg), position the lifting straps of an appropriate hoist or swing crane around the ARGUS ball valve body or attach them to lifting eyelets, if they are present.
🔗 See Chapter 12 Transportation.

2. Transport the ARGUS ball valve to its storage location.
3. Extend the useful life of the ARGUS ball valve by ensuring the following storage conditions at the storage location are fulfilled:
 - ① Storage location conditions of the ARGUS ball valve:

Indoor (long-term storage):

 - dry, free of dust and adequately ventilated
 - storage temperature between +5 °C and +40 °C
 - relative humidity of < 50 %

Outdoor/construction site area (short-term storage; ≤ 7 days):

 - storage temperature between –10 °C and +50 °C
 - ✓ The preparations for the storage of the ARGUS ball valve have been completed.
 - ① The operability of the ARGUS ball valve must be checked by an inspection of the ARGUS ball valve after (longer) storage and before commissioning. Carry out the maintenance work (section 7.3) listed in chapter 7 Maintenance on the ARGUS ball valve.

11 Packaging

11.1 Safety Messages



In order to prevent personal injury and/or property damage, ensure that packaging work is only carried out by qualified personnel with appropriate personal protective equipment (PPE) and suitable work tools.

🔗 See Chapter 2 Safety Information.

NOTICE

Risk of property damage due to improper packaging!

Improper packaging of the ARGUS ball valve may cause damage during transportation.

▶ Follow the procedures in the section below closely.

11.2 Packaging the ARGUS Ball Valve



Ensure that the following conditions apply:
The ARGUS ball valve

- Is disconnected from the piping
- Is free from any fluid residues and trapped pressure (observe national regulations on disposal of hazardous waste)
- Is in the open position (as supplied)
- Is free from any dirt
- Is dry
- Attach protective factory fitted caps to the ARGUS ball valve (including Volatile Corrosion Inhibitor paper).



Protective factory fitted caps prevent the penetration of dirt and foreign particles into the interior of the ARGUS ball valve. The caps also protect the flange sealing surface, the welding end, and the connecting thread from corrosion and other damage.

1. Choose suitable packaging to guarantee that the ARGUS ball valve reaches its destination without any damage (e.g., "seaworthy" packaging).
-  When choosing suitable packaging, please observe customer specifications, applicable laws, load securing regulations, the properties of the transported goods (dimensions and weight), the protection requirements and the type of transport (road, rail, air and/or sea freight).
2. If necessary, protect/secure the ARGUS ball valve against tipping over and slipping.
3. If necessary – particularly in the case of sea freight – display appropriate and clearly visible transportation symbols on the packaging in accordance with ISO 780 and DIN 55402.

① Transport symbols on the boxes are either laminated or sprayed on with weatherproof paint.

Possible transportation symbols are:



This side up



Fragile goods



Keep dry



Protect from direct sunlight



Center of gravity



Do not use hooks





Attach chain here

✓ The packaging of the ARGUS ball valve is now complete.

12 Transportation

12.1 Safety Messages

	<p><i>In order to prevent personal injury and/or property damage, ensure that transportation work is only carried out by qualified personnel with appropriate personal protective equipment (PPE) and suitable work tools.</i></p> <p><i>☞ See Chapter 2 Safety Information.</i></p> <p><i>In order to prevent personal injury and/or property damage, observe the transport instructions in chapter 4 of the superior instructions VAIOM001028.</i></p>
-----------------------------------------------------------------------------------	------------------------------------------------------------------------------------------------------------------------------------------------------------------------------------------------------------------------------------------------------------------------------------------------------------------------------------------------------------------------------------------------------------------------------------------------------------------------

	<p style="background-color: red; color: white; padding: 5px;">⚠ DANGER</p> <p>Risk of injury due to falling loads!</p> <p>Incorrect attachment of loads may cause severe injury or death.</p> <ul style="list-style-type: none"> ▶ Correctly attach the ARGUS ball valve and/or actuator. ☞ See following Section 12.2 and the superior instructions VAIOM001028. ▶ Never stand under heavy load.
-----------------------------------------------------------------------------------	---------------------------------------------------------------------------------------------------------------------------------------------------------------------------------------------------------------------------------------------------------------------------------------------------------------------------------------------------------------------------------------------------------------------------------------------

	<p style="background-color: orange; color: black; padding: 5px;">⚠ WARNING</p> <p>Risk of injury due to improper transportation!</p> <p>Improper transportation may lead to severe injury.</p> <ul style="list-style-type: none"> ▶ Correctly attach the ARGUS ball valve and/or actuator. ☞ See following Section 12.2 and the superior instructions VAIOM001028. ▶ Observe all load-handling regulations.
-------------------------------------------------------------------------------------	-------------------------------------------------------------------------------------------------------------------------------------------------------------------------------------------------------------------------------------------------------------------------------------------------------------------------------------------------------------------------------------------------------------------------------------------------------

NOTICE	
<p>Risk of property damage due to improper transportation!</p> <p>Improper transportation of the ARGUS ball valve may cause damage.</p> <ul style="list-style-type: none"> ▶ Use protective packaging materials to protect the ARGUS ball valve from damage during transport (e.g., packaging cover). ▶ Follow the procedures specified in the section below closely. 	

12.2 Transporting the ARGUS Ball Valve



Ensure that the following conditions apply:
The ARGUS ball valve

- Is disconnected from the piping
- Is free from any fluid residues and trapped pressure (observe national regulations on disposal of hazardous waste)
- Is in the open position (as supplied)
- Is free from any dirt
- Is dry

1. Attach protective factory fitted caps to the ARGUS ball valve (including Volatile Corrosion Inhibitor paper).



Protective factory fitted caps prevent the penetration of dirt and foreign particles into the interior of the ARGUS ball valve. The cap also protects the flange sealing surface, the welding end, and the connecting thread from corrosion and other damage.

2. Use protective packaging materials to protect the ARGUS ball valve from damage during transport (e.g., packaging cover).



Transport of heavy ARGUS ball valves (≥ 15 kg) requires a suitable hoist. Depending on the type of ball valve, round slings are wrapped around both sides of the ball valve body, or the ball valve's lifting lugs are used, if present. Note that the hoist must be attached to no less than two lifting lugs for the FK 75F series, and no less than four lifting lugs, for the FK 76M series (\geq DN 300).

3. For heavy ARGUS ball valves (≥ 15 kg), attach the hoist to the ball valve in a suitable way (see previous note).



Note that when using round slings, the center of gravity may be above the attachment points.

For center of gravity data of the FK 76M, FK 75M, and FK 75F series, please refer to Annex E: Centers of Gravity of FK 75M, FK 75F, FK 76M.

Mind the suitable work loads of attachment points given in Annex F: Safe Working Load (SWL) .

⚠ WARNING

Risk of injury due to tipping ARGUS ball valve FK 75F due to off-centre of gravity when fastening to lifting eyes!

A tipping ARGUS ball valve FK 75F can cause death or severe injury.

- ▶ Secure the ARGUS ball valve FK 75F with a round sling around body 2 in addition to the lifting eyes.

4. In the case of an ARGUS ball valve FK 75F, stabilise the position with a round sling around body 2 additionally to the lifting eyes to balance out the off-centre of gravity.



Fastening with round slings



Fastening with lifting eyes

5. Put the lifting straps into the load hook of an appropriate hoist or swing crane.
6. Lift the ARGUS ball valve to the desired location and set it down safely.
7. Remove the lifting straps from the ARGUS ball valve.
- ✓ Preparation of the ARGUS ball valve for transport and its transport are now complete.

13 Disposal and Recycling

13.1 Safety Messages

	<p><i>In order to prevent personal injury and/or property damage, ensure that disposal and recycling work is only carried out by qualified personnel with appropriate personal protective equipment (PPE) and suitable work tools.</i></p> <p>🔗 See Chapter 2 Safety Information.</p>
--	---------------------------------------------------------------------------------------------------------------------------------------------------------------------------------------------------------------------------------------------------------------------------------------

	<p>⚠️ WARNING</p> <p>Risk of injury from fluid residues and trapped pressure!</p> <p>Fluid residue and trapped pressure can cause serious injury or death.</p> <ul style="list-style-type: none"> ▶ Operate the ARGUS ball valve several times so that fluid residues and trapped pressure can escape. ▶ Use a vessel to collect any fluid residues and dispose of them properly.
--	-------------------------------------------------------------------------------------------------------------------------------------------------------------------------------------------------------------------------------------------------------------------------------------------------------------------------------------------------------------------------------------------------------------------------

	<p>NOTICE</p> <p>Risk of environmental pollution due to fluid residues!</p> <p>Fluid residues may harm the environment.</p> <ul style="list-style-type: none"> ▶ Operate the ARGUS ball valve several times so that fluid residues and trapped pressure can escape. ▶ Use a vessel to collect any fluid residues and dispose of them properly.
--	--------------------------------------------------------------------------------------------------------------------------------------------------------------------------------------------------------------------------------------------------------------------------------------------------------------------------------------------------------------------------------------

13.2 Disposing and Recycling the ARGUS Ball Valve

At the end of the ARGUS ball valve useful life, all materials and parts must be recycled or disposed of in accordance with local/regional environmental laws and regulations. If the ARGUS ball valve contains hazardous substances or toxic fluid residues which are harmful to the environment or to health, removal and disposal of the ARGUS ball valve must adhere to local/regional regulations and laws on waste disposal.



The ARGUS ball valve is

- Decommissioned
- Disconnected from the piping, the actuator and the control components
- Depressurized
- Decontaminated (free from hazardous substances or toxic fluid residues)

1. Consign the ARGUS ball valve to an authorized waste disposal and/or recycling company.



The authorized waste disposal or recycling company will transfer the ARGUS ball valve into the disposal or recycling circuit.



Disposal or recycling is now complete.

Annex A: Declaration of Conformity



EU Declaration of Conformity acc. Directive 2014/68/EU

(Translation of AZ1787_DE)

Product:

Argus-Ball Valve-Types

Type	DN	Type	DN
FK 75, FK 75M, FK 75F, FK76, FK 76M, FK78	65 - 1200	KK 8, KK 51	32 - 80
FK79, FK 79FC	15 - 100	MW 8	04 - 25
HK 35	40 - 900	MW 2	32 - 40
BK 8, BK 9, BK 10	04 - 25	MW 22	50 - 100
MK 8, MK10	25 - 50	MW 76, MW 76 (Combination), MW 76M	32 - 300

Note: In compliance with article 4 paragraph 3 of Directive 2014/68/EU, ball valves of nominal size up to DN 25 are "designed and manufactured in accordance with the sound engineering practice ... in order to ensure safe use". Such valves do not bear the CE marking.

Manufacturer:

Flowserve Flow Control GmbH
Rudolf-Plank-Str. 2
D-76275 Ettlingen

Directive:

2014/68/EU of the European Parliament and the Council of 15 May 2014 „Pressure Equipment Directive (PED)“

Flowserve Flow Control GmbH, the manufacturer, hereby declares under sole responsibility that the above listed products are in compliance with the provisions of Directive 2014/68/EU. The equipment is subjected to a conformity assessment procedure according Module H. A Full Quality Assurance System as stipulated in annex III section 11 "Module H" is applied.

The quality assurance system is monitored by the notified body:

TÜV Süd Industrie Service GmbH
Westendstraße 199, D-80686 München
Identification code: **0036**
Certificate No.: **DGR-0036-QS-1067-..** (in the valid version)

Technical standards applied:
AD2000 Rulebook, Series A4; EN 12516-2

Peter Benien
Managing Director

Thorsten Hecht
Head of Research & Development

Ettlingen, 01 April 2022

Experience In Motion

Flowserve Flow Control GmbH
argus@flowserve.com
www.flowserve.com

AZ1787 EN S.1/1
Rev.: Q

Annex B: Declaration of Incorporation



Declaration of Incorporation acc. Directive 2006/42/EC

(Translation of AZ2215_DE)

Product:

Argus-Ball Valve-Types

Type	DN	Type	DN
FK 75, FK 75M, FK 75F, FK76, FK 76M, FK78	65 - 1200	KK 8, KK 51	32 - 80
FK79, FK 79FC	15 - 100	MW 8	04 - 25
HK 35	40 - 900	MW 2	32 - 40
BK 8, BK 9, BK 10	04 - 25	MW 22	50 - 100
MK 8, MK10	25 - 50	MW 76, MW 76 (Combination), MW 76M	32 - 300

Manufacturer and Authorized Person for the Compilation of the Technical Documentation:

Flowserve Flow Control GmbH
Rudolf-Plank-Str. 2
D-76275 Ettlingen

Directive:

2006/42/EC of the European Parliament and the Council of 17. May 2006, „European Machinery Directive“

Flowserve Flow Control GmbH as the manufacturer hereby declares that the above listed ball valve types and their variants, that are intended for automated operation in combination with pneumatic, electric or hydraulic actuation systems fulfill the basic requirements of the Directive 2006/42/EC for “partly completed machinery”: Annex I, paragraphs 1.1.2, 1.1.3, 1.1.5, 1.2.1, 1.3.2, 1.3.3, 1.3.4., 1.3.7, 1.3.8, 1.5.2, 1.5.4, 1.5.6, 1.5.7, 1.5.13, 1.6.1, 1.7.1, 1.7.2, 1.7.3 & 1.7.4.

The conformity assessment was carried out in accordance with the harmonized standard EN ISO 12100:2010.

Commissioning is prohibited until it has been ensured that the entire machine or system in which the Flowserve ball valves are installed comply with the provisions of Directive 2006/42/EC.

The relevant technical documentation for partly completed machinery in accordance with Annex VII, part B, has been created and can be provided to national authorities in case of justified requirement.

The operating manual must be observed.

Applied standard:

- EN ISO12100:2010

Peter Benien
Managing Director

Thorsten Hecht
Head of Research & Development

Ettlingen, 01 April 2022

Experience In Motion

Flowserve Flow Control GmbH
argus@flowserve.com
www.flowserve.com

AZ2215 EN S.1/1
Rev.: C

Annex C: Pressure-Temperature Diagrams for Ball Seats

Annex C: Pressure-Temperature Diagrams for Ball Seats



Observe the operating parameters/limits shown in the diagrams.

FK 75M, 76M (restructured)

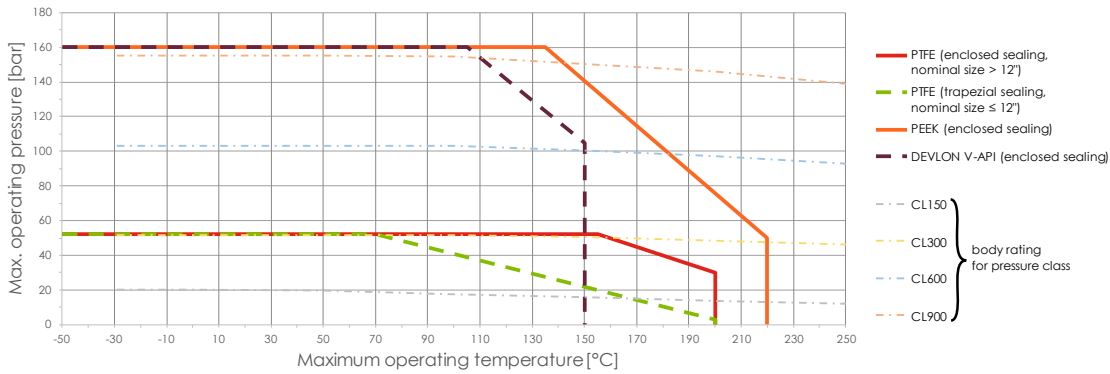

PN 10/16:
FK 79, FK 75/M, FK 76/M, HK 35

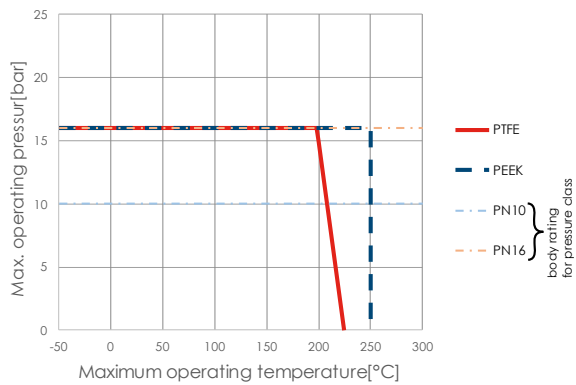

PN 25, Cl. 150:
FK 79, FK 75/M, FK 76/M, HK 35

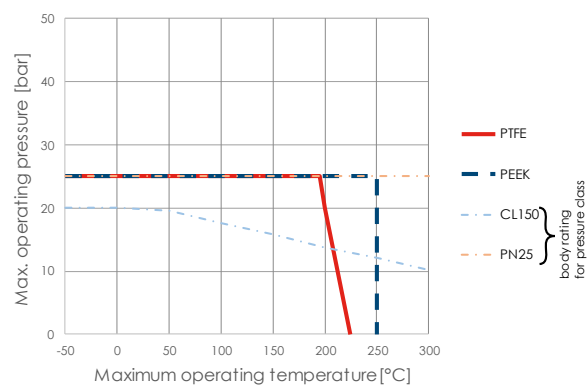

PN 40/63/100, Cl. 300/600:
FK 79, FK 75/M, FK 76/M, HK 35

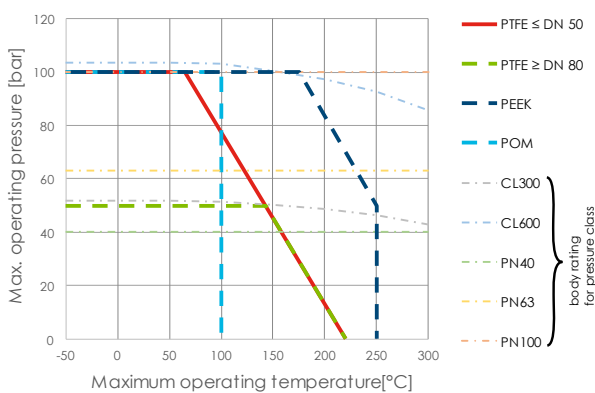

PN 160, Cl. 900:
FK 79, FK 76M, HK 35

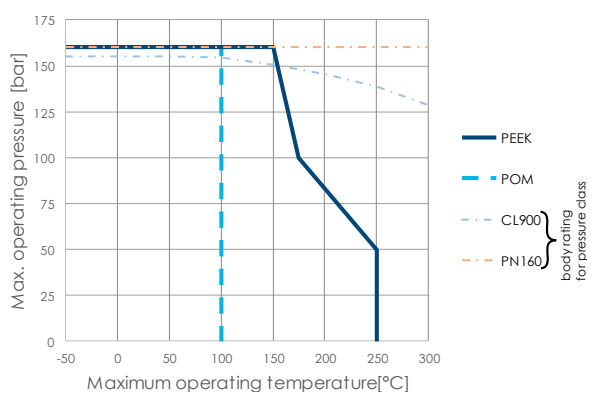

The pressure-temperature diagram shows only recommended values. Please contact Flowserve Flow Control GmbH for the evaluation of the process conditions and choice of suitable material.

Annex D: Max. Permissible Screw Tightening Torques for Stuffing Box

Annex D: Max. Permissible Screw Tightening Torques for Stuffing Box

Argus Type/ Valve Series	Nominal Diameter		Class	Stem *	Screws			
	DN	NPS			Quantity	Size	Torque Nm	
FK 79	15 – 25	0,5" – 1"	150	2FL SW 12	2	M10	13	
			300		2		13	
			600		2		17	
	40 – 50	1,5" – 2"	150	2FL SW 17	2	M10	13	
	40 – 50	1,5" – 2"	300		2		16	
			600	2	21			
FK 75M / FK 76M	80 – 100	3" – 4"	150	2FL SW 19	2	M12	22	
			300		2		22	
			600		2		29	
			900		2		106	
	150 – 200	6" – 8"	150	2FL SW 36	2	M16	54	
			300		2		54	
			600		2		71	
			900		2		182	
	250 – 300	10" – 12"	150	4KT SW 55	2	M20	93	
			300	4KT SW 55	2		93	
			600	4KT SW 55	2		121	
			900	W 80	2		239	
	350 – 400	14" – 16"	150	4KT SW55	2	M20	122	
			300	4KT SW55	2		122	
			600	W 80	2		159	
			900	W 100	2		517	
	FK 75F	50	2"	150	2FL SW 14	4	UNC 5/16"-18	16
				300	2FL SW 18	4		19
600				2FL SW 20	4	UNC 3/8"-16	28	
900				W 28	6	UNC 5/16"-18	16	
1500				W 28	6	UNC 7/16"-14	20	
2500				W 28	6		23	
80		3"	150	2FL SW 18	4	UNC 5/16"-18	19	
			300	2FL SW 25	4	UNC 3/8"-16	30	
			600	2FL SW 30	4	UNC 7/16"-14	43	
			900	W 40	6	UNC 3/8"-16	26	
			1500		6	UNC ½"-13	45	
			2500		6	51		
100		4"	150		2FL SW 20	4	UNC 3/8"-16	28
			300	2FL SW 30	4	UNC 7/16"-14	38	
			600	2FL SW35	4	UNC 3/8"-16	80	
			900	W 45	6	UNC 7/16"-14	35	
			1500		6	UNC 5/8"-11	48	
			2500		6	48		
150		6"	150		2FL SW 30	4	UNC 7/16"-14	38
			300	2FL SW 40	4	UNC ½"-13	80	
			600	2FL SW 50	4	UNC 5/8"-11	126	
			900	6	90			
			1500	W 65	6	UNC ¾"-10	93	
			2500		6		93	

Maximum tightening torques for stuffing boxes

Annex D: Max. Permissible Screw Tightening Torques for Stuffing Box

Argus Type/ Valve Series	Nominal Diameter		Class	Stem*	Screws		
	DN	NPS			Quantity	Size	Torque Nm
FK 75F	200	8"	150	2FL SW 35	4	UNC 7/16"-14	45
			300	2FL SW 50	4	UNC 5/8"-11	111
			600	2FL SW 65	4	UNC 3/4"-10	220
			900	W 80	6	UNC 5/8"-11	126
			1500	W 85	6	UNC 1"-8	210
			2500		6		223
	250	10"	150	2FL SW 45	4	UNC 5/8"-11	111
			300	2FL SW 60	4	UNC 3/4"-10	197
			600	2FL SW 80	4	UNC 1"-8	421
			900	W 95	6	UNC 3/4"-10	263
			1500	W 100	6	UN 1 1/8"-8	374
			2500		6		400
	300	12"	150	2FL SW 55	4	UNC 5/8"-11	126
			300	2FL SW 70	4	UNC 3/4"-10	220
			600	2FL SW 95	4	UNC 1"-8	495
			900	W 110	6	UNC 3/4"-10	281
			1500	W 120	6	UN 1 1/4"-8	369
			2500		6		461
HK 35	50	2"	900	2FL SW 19	2	M12	43
			1500		2		72
			2500		2		120
	80	3"	900	4KT SW 27	2	M16	87
			1500		2		145
			2500		2		120
	100	4"	900	4KT SW 36	2	M16	106
			1500		2		177
			2500		2		150
	150 – 200	6" – 8"	900	4KT SW 55	2	M20	90
			1500		2		90
			2500		2		220
	250	10"	900	W 80	2	M20	117
			1500		2		117
			2500		2		390
	300	12"	900	W 80	2	M20	117
			1500	W 90	2	M30	290
			2500	W 120	2	M36	550
				W 120	4	M30	230

Maximum tightening torques for stuffing boxes

For ARGUS ball valves not listed, please contact Flowserve Flow Control GmbH.

*Legend stem designation: 2FL = double-D stem, 4KT = square stem,
SW = width across flats, number indicates width across flats in mm,
W = toothed stem, number indicates tooth width in mm

Annex E: Centers of Gravity of FK 75M, FK 75F, FK 76M series

Argus Typ/Valve series	Nominal Diameter		Pressure Rating		Center of gravity		
	DN	NPS	PN	CLASS	x [mm]	y [mm]	z [mm]
FK 75M	80 - 100	3" - 4"	10-40	150 - 300	5 ±10	5 ±5	0 ±5
FK 75F	50	2"	-	150-600	5 ±10	10 ±5	0 ±5
				900-2500	25 ±10	10 ±5	0 ±5
	80	3"	-	150-600	10 ±10	10 ±5	0 ±5
				900-2500	25 ±10	15 ±5	0 ±5
	100	4"	-	150-600	15 ±10	10 ±5	0 ±5
				900-2500	30 ±10	15 ±5	0 ±5
	150	6"	-	150-600	25 ±10	10 ±5	0 ±5
				900-2500	50 ±10	15 ±5	0 ±5
	200	8"	-	150-600	30 ±10	10 ±10	0 ±5
				900-2500	60 ±10	15 ±10	0 ±5
	250	10"	-	150-600	35 ±15	15 ±10	0 ±5
				900-2500	70 ±15	20 ±10	0 ±5
300	12"	-	150-600	35 ±15	15 ±10	0 ±5	
			900-2500	75 ±15	15 ±10	0 ±5	
FK 76M	80 - 125red	3" - 5"red	10 - 100	150 - 600	10 ±10	5 ±5	0 ±5
			160	900	15 ±10	5 ±5	0 ±5
	150 - 300	6" - 12"	10 - 100	150 - 600	30 ±20	10 ±5	0 ±5
			-	900	0 ±10	5 ±5	0 ±5
350 - 600	14" - 24"	-	150-900	0 ±10	0 ±10	0 ±5	

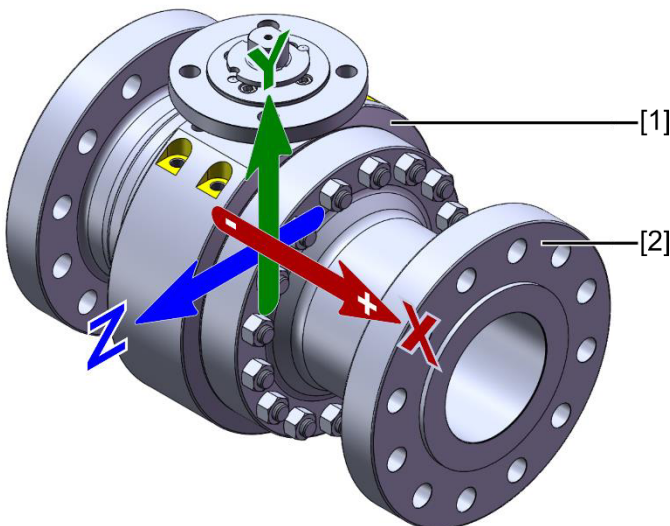

x: Offset from the stem axis: - = shift towards body 1 [1]; + = shift towards body 2 [2] (only relevant for two-part bodies)

y: Offset from the flow axis: - = shift towards the bottom; + = shift towards the stem

z: Offset from the stem axis at a right angle to the flow axis

Annex F: Safe Working Load (SWL) of Attachment Points

ADB Safety Engineered Hoist Rings / Heavy Duty Hoist Rings

Thread Size	SWL	
	[kg]	[lbs]
[Inch]		
UNC 3/8"-16	454	1000
UNC 3/8"-16	454	1000
UNC 1/2"-13	1021	2250
UNC 5/8"-11	1814	4000
UNC 3/4"-10	2268	5000
UNC 7/8"-9	3629	8000
UNC 1"-8	4536	10000
UNC 1 1/4"-7	6804	15000
UNC 1 3/8"-6	9072	20000
UNC 1 1/2"-6	10886	24000
UNC 2"-4,5	13608	30000

SunPoint Eyebolts SPK

Thread Size	SWL	
	[kg]	[lbs]
[mm]		
M6	100	220
M8	300	661
M10	400	882
M12	750	1.653
M16	1500	3307
M20	2300	5071
M24	3200	7055
M30	4500	9921
M36	7000	15432
M42	9000	19841



Flowserve Factory Contacts:

Flowserve Flow Control GmbH
Rudolf-Plank-Str. 2
76275 Ettligen
Germany
Phone: +49 7243 1030
Fax: +49 7243 103222
Email: argus@flowserve.com
www.flowserve.com

Instructions for download:



www.flowserve.com/en/argus-iom

Local Flowserve Representative:

To find your local Flowserve representative use the Sales Support Locator System found at www.flowserve.com.

FLOWSERVE REGIONAL SALES OFFICES:

America

Flowserve Corporation
3993 W. Sam Houston
Parkway North
Suite 100
Houston, TX 77043

China

Beijing Flow Control Operations
22A1/A2, Hanwei Plaza
No. 7 Guanghua Road,
Chaoyang District,
Beijing 100004, China

Flowserve China & Southeast Asia
Suzhou Office
No.49 Weixin Road,
Suzhou Industrial Park,
Jiangsu Province, China, 215122

Asia Pacific

Flowserve Pte. Ltd.
12 Tuas Avenue 20
Republic of Singapore 638824
Phone: 65 862 3332
Fax: 65 862 2800

Flowserve Corporation has established industry leadership in the design and manufacture of its products. When properly selected, this Flowserve product is designed to perform its intended function safely during its useful life. However, the purchaser or user of Flowserve products should be aware that Flowserve products might be used in numerous applications under a wide variety of industrial service conditions. Although Flowserve can provide general guidelines, it cannot provide specific data and warnings for all possible applications. The purchaser/user must therefore assume the ultimate responsibility for the proper sizing and selection, installation, operation, and maintenance of Flowserve products. The purchaser/user should read and understand the instructions included with the product and train its employees and contractors in the safe use of Flowserve products in connection with the specific application.

While the information and specifications contained in this literature are believed to be accurate, they are supplied for informative purposes only and should not be considered certified or as a guarantee of satisfactory results by reliance thereon. Nothing contained herein is to be construed as a warranty or guarantee, express or implied, regarding any matter with respect to this product. Because Flowserve is continually improving and upgrading its product design, the specifications, dimensions and information contained herein are subject to change without notice. Should any question arise concerning these provisions, the purchaser/user should contact Flowserve Corporation at any one of its worldwide operations or offices. For more information about Flowserve Corporation, contact www.flowserve.com or call USA 1-800-225-6989.

© November 2020, Flowserve Corporation, Irving, Texas