

*Process Flow Diagrams*

# BREWERY

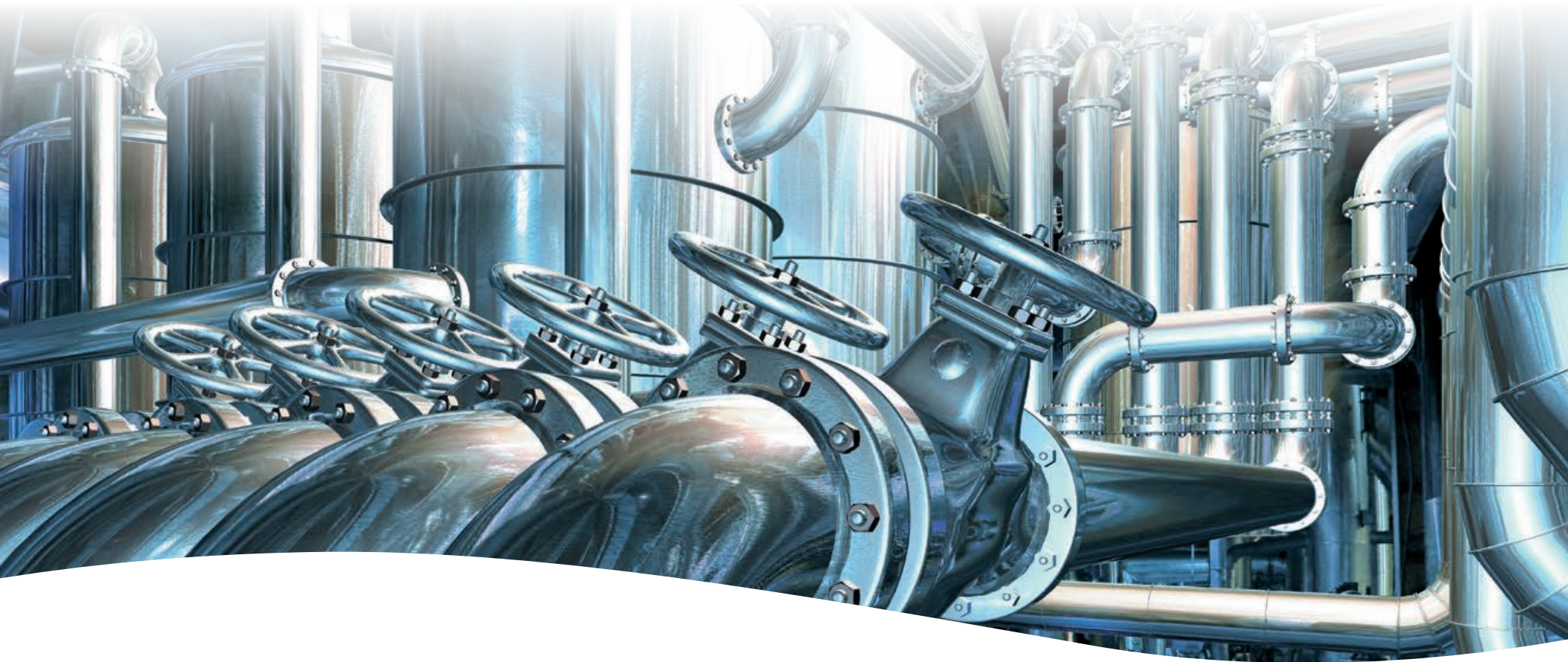

*Experience In Motion*

The Beer Brewing Process

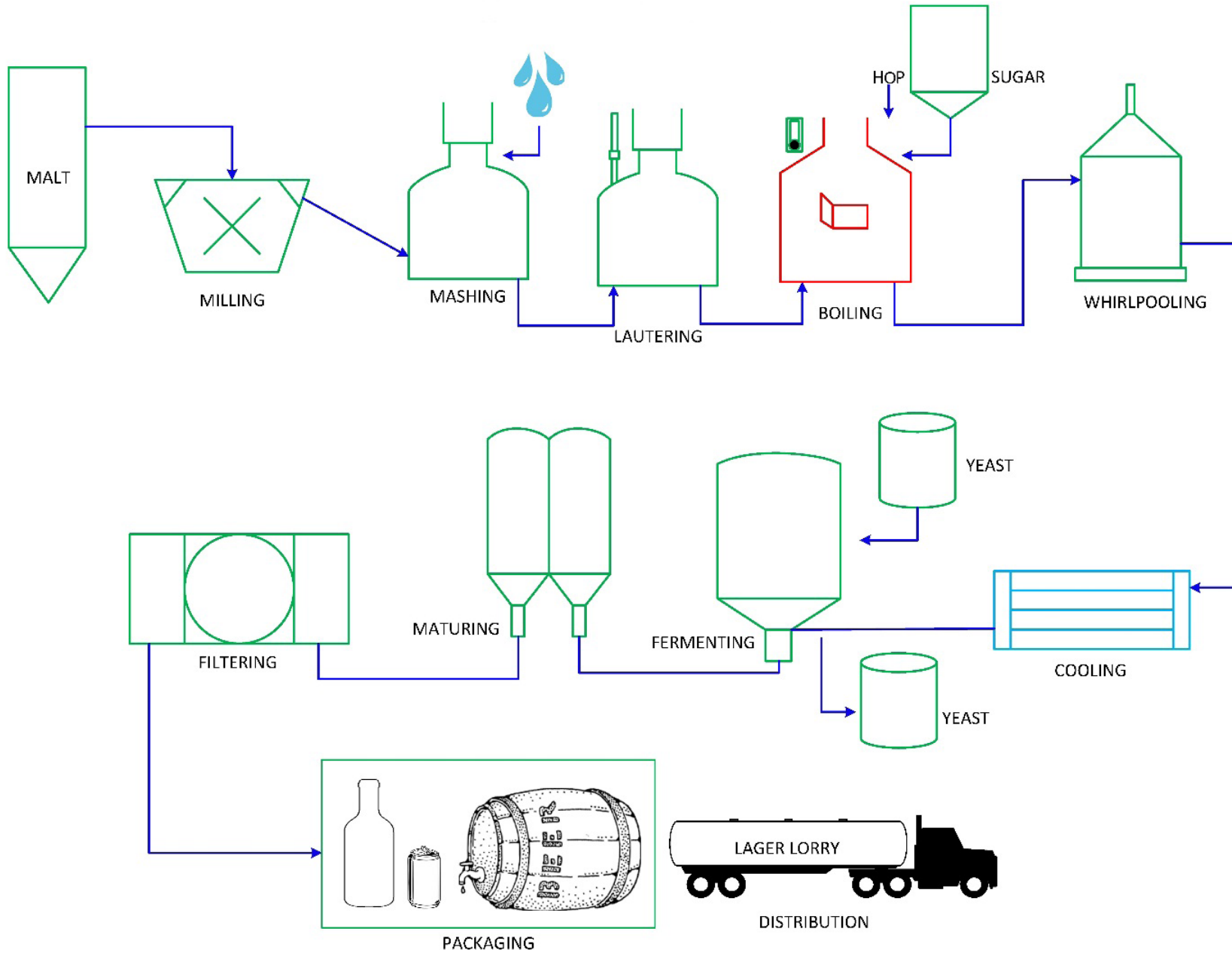

Fermentation Process

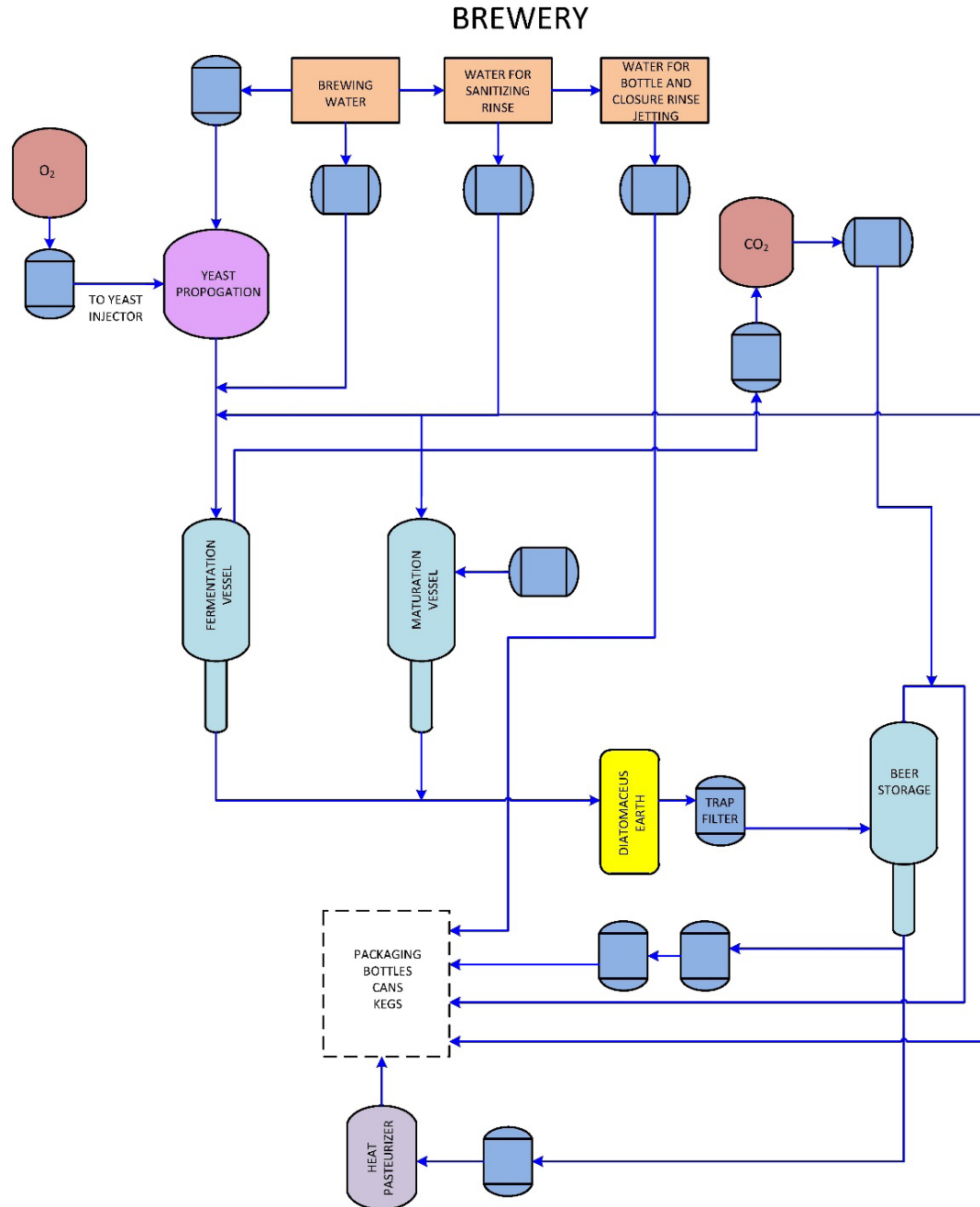

Three Primary Brewing Processes

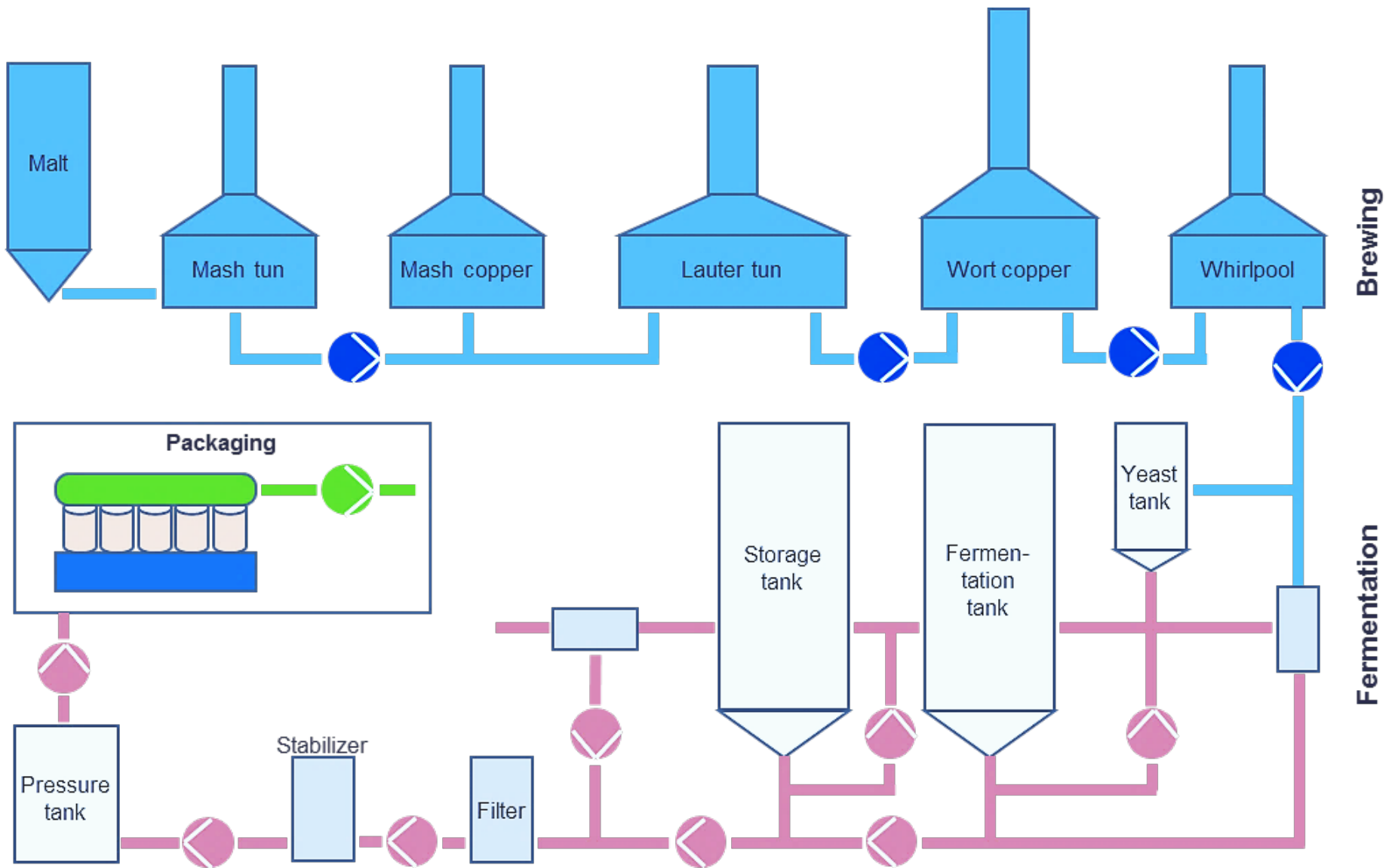

Malt Whiskey Manufacturing Process

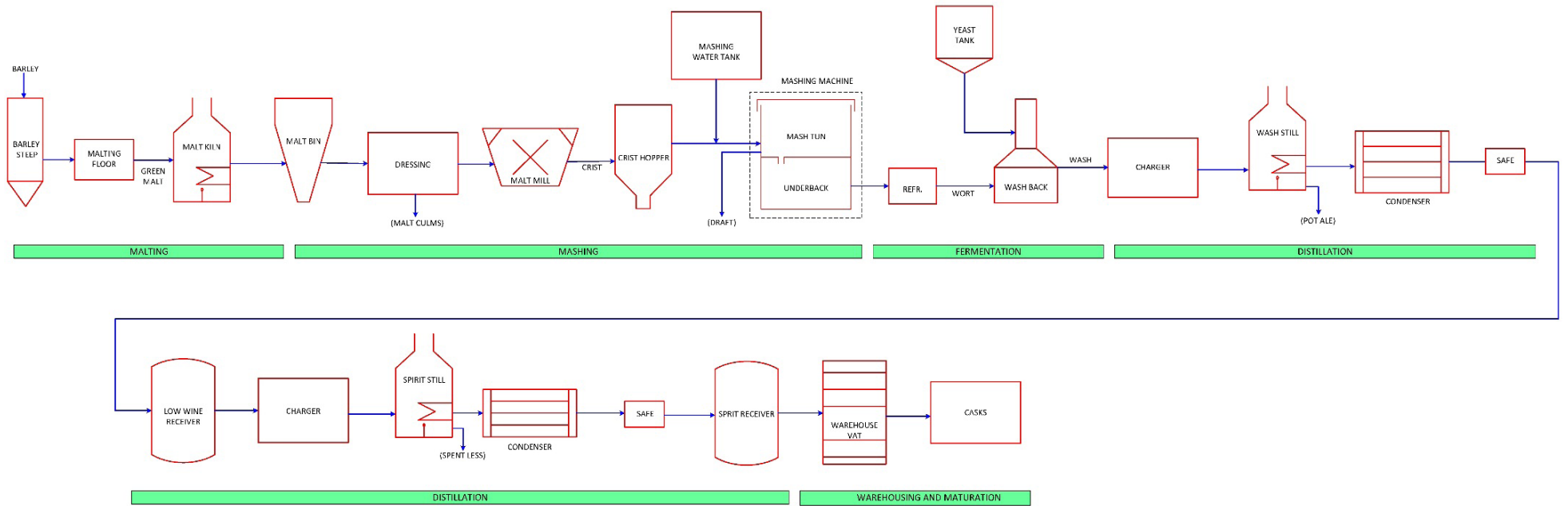



## A Typical Flowserve Pump Application for the Distillation Process

### 1. Feed pumps

Centrifugal pumps for feeding the react to the distillation vessel



### 2. Heat transfer pumps

Centrifugal pumps for handling high-temperature fluids

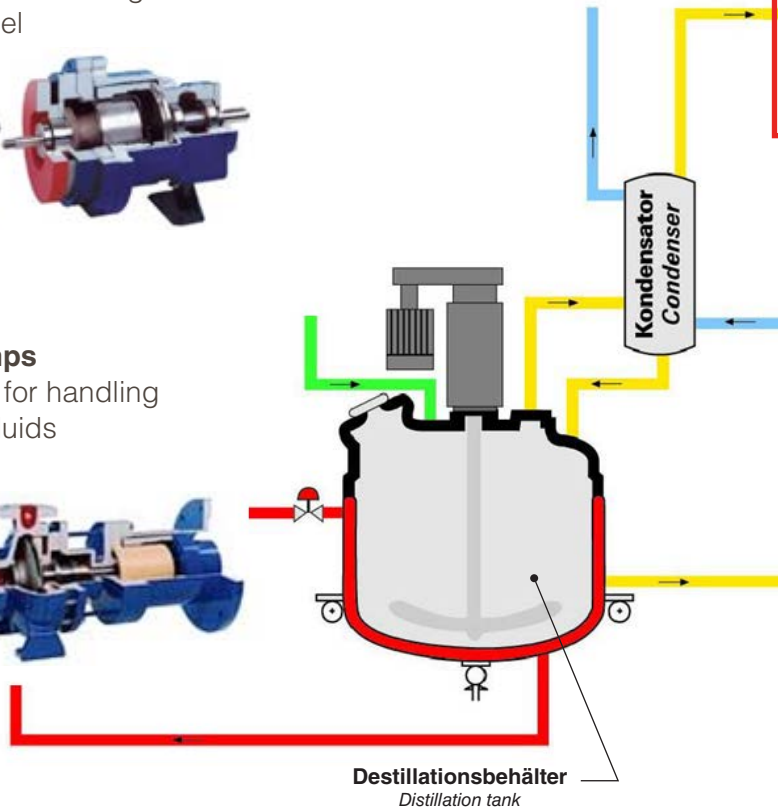

### 5. Vacuum pumps/systems

Vacuum pumps for running the process under lower temperatures



### 4. Cooling water pumps

Centrifugal pumps for circulation of cooling media at heat exchangers



### 3. Discharge pumps

Centrifugal pumps for transferring the distillation product into next production stages or storage tanks

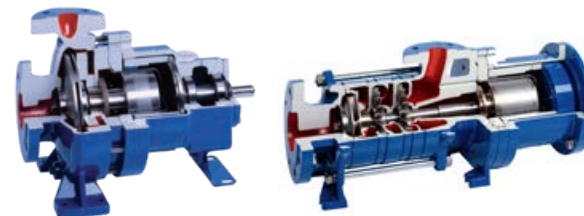



North America

Latin America

Europe

Middle East

Africa

Asia-Pacific

Flowserve Corporation  
5215 North O'Connor Boulevard  
Suite 2300  
Irving, Texas 75039  
[flowserve.com](http://flowserve.com)

***Experience In Motion***

FLS-1017a (E/AQ) ASG-Brewery, December 2019 © 2019 Flowserve Corporation. All rights reserved. Kämmer, Logix, NAF, Valbart, Valtek, Flowserve, and the Flowserve design are registered marks of Flowserve Corporation. All other marks are the property of their respective owners.