

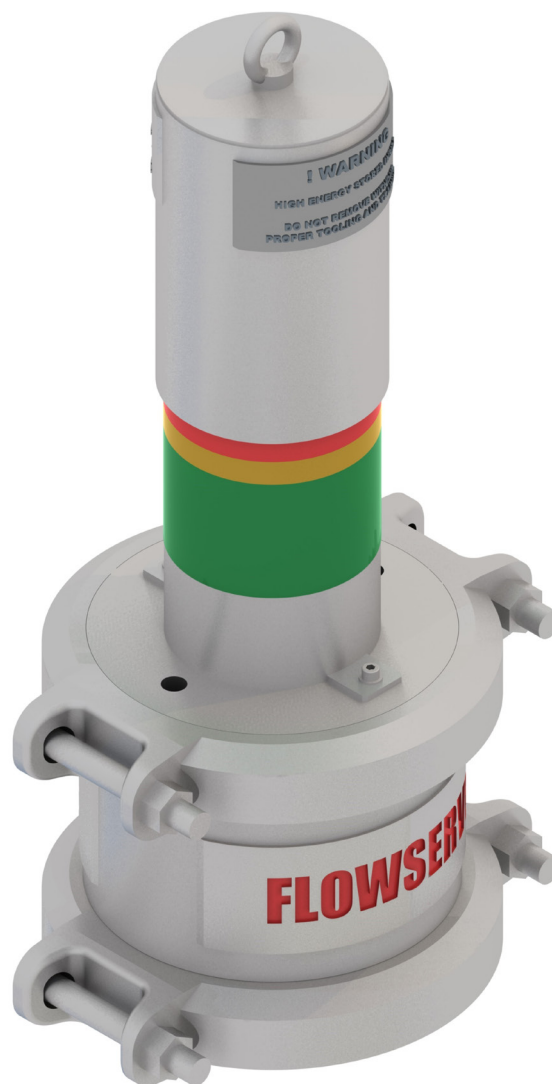

## USER INSTRUCTIONS

*Installation*  
*Operation*  
*Maintenance*

# N53C Piston Accumulator



## CONTENTS

|          |  |           |
|----------|--|-----------|
| <b>1</b> | <b>Introduction</b>  | <b>3</b>  |
| 1.1      | About this manual  | 3         |
| 1.2      | How to use this manual   | 3         |
| 1.3      | Other supplied documents   | 3         |
| 1.4      | Use of alerts and icons  | 4         |
| <b>2</b> | <b>Safety</b>  | <b>5</b>  |
| 2.1      | Types of hazardous exposures                                     | 5         |
| 2.2      | General safety   | 5         |
| 2.3      | Trained and qualified personnel                                  | 5         |
| 2.4      | Personal protective equipment (PPE)                              | 5         |
| 2.5      | Actions in extreme conditions                                    | 5         |
| <b>3</b> | <b>Environmental Considerations</b>                              | <b>6</b>  |
| 3.1      | Disposing of waste products                                      | 6         |
| 3.2      | End-of-life equipment  | 6         |
| <b>4</b> | <b>Description</b>   | <b>7</b>  |
| 4.1      | Product purpose  | 8         |
| 4.2      | Design features  | 8         |
| 4.3      | Product components   | 8         |
| 4.4      | Operating principle  | 8         |
| 4.5      | Identifying the product (type plate)                             | 10        |
| <b>5</b> | <b>Preservation, Packing, Transport and Storage Requirements</b> | <b>11</b> |
| 5.1      | Mechanical preservation instructions                             | 11        |
| 5.1.1    | Preservation   | 11        |
| 5.1.2    | Installation   | 11        |
| 5.2      | Packing  | 11        |
| 5.3      | Transportation and storage requirements                          | 12        |
| <b>6</b> | <b>Installation</b>  | <b>13</b> |
| 6.1      | Introduction   | 13        |
| 6.2      | Safety considerations  | 13        |
| 6.3      | Installation requirements  | 13        |
| 6.4      | Product set-up   | 14        |
| 6.4.1    | Mounting   | 14        |
| 6.4.2    | Connections  | 15        |
| 6.4.3    | Interconnecting piping   | 15        |
| 6.5      | Installation procedure   | 16        |
| <b>7</b> | <b>Operation</b>   | <b>17</b> |
| 7.1      | Start-up   | 17        |
| 7.2      | Product monitoring   | 17        |
| 7.3      | Shut down product  | 18        |
| <b>8</b> | <b>Maintenance</b>   | <b>20</b> |
| 8.1      | General guidelines   | 20        |
| 8.2      | Periodic maintenance tables                                      | 20        |
| 8.3      | Inspection procedure   | 21        |
| <b>9</b> | <b>Troubleshooting</b>   | <b>22</b> |
|          | <b>ANNEX I</b>   | <b>23</b> |
|          | <b>ANNEX II</b>  | <b>24</b> |

## 1 Introduction

### 1.1 About this manual

The present manual is intended to ensure the safe installation and effective operation of the N53C Piston Accumulator. All applicable personnel are obliged to review and follow the guidance provided by this manual.

**NOTE:** As hazardous conditions can result from planned as well as unforeseen circumstances, pressurized equipment shall always be operated with caution.

Before installation, equipment should always be fully inspected including, but not limited to checking for:

- Any possible damage due to transport or storage
- Cleanliness required before operation
- Existence of an affixed nameplate with correct inspection markings and design/test conditions clearly annotated

### 1.2 How to use this manual

Only trained and qualified personnel should install or operate the equipment. Refer to section 2.3 for safe product operation. Inexperienced personnel should only work on this system under the supervision of a qualified person.

Before using this manual, make sure you have fully read and understand the safety section. Section 5 describes the system in detail.

When system maintenance is performed, ensure that maintenance procedures are followed, paying close attention to the alerts and safety icons.

### 1.3 Other supplied documents

The assembly drawing is included with the N53C piston accumulator.

## 1.4 Use of alerts and icons

This manual uses “Notes”, “Cautions” “Warnings” and “Dangers” to alert you of important information and/or hazardous situations.

**NOTE:** “Notes” inform you of important additional information.

 **CAUTION:** *The equipment, product or surrounding area can be damaged if the “caution” is not obeyed.*

 **WARNING:** *Personnel can be (seriously) injured, or the equipment can be seriously damaged if the “warning” is not obeyed.*

 **DANGER:** *Personnel can be (seriously) injured if the “danger” sign is not obeyed.*

The above icons are the general icons that are used for “Cautions”, “Warnings” and “Dangers”. More specific icons are also used, depending on the type of hazard. All icon used in this manual are listed below:

 **WARNING – HIGH PRESSURE:** *The N53C Piston Accumulator boosts the pressure of the pump process fluid. Review the pressure rating of all components connected to the accumulator to prevent over pressurization. If there is a possibility of pressure exceeding the pipe plan design pressure, a pressure relief valve shall be installed to prevent over pressurization.*

 **WARNING – HOT SURFACES: HOT SURFACES:** *The system and surrounding surfaces might be hot. Take care when touching components. Wear the appropriate Personal Protection Equipment (PPE), according to plant regulations.*

 **WARNING – HAZARDOUS CHEMICALS: TOXIC, CAUSTIC OR CORROSIVE CHEMICALS:** *The N53C Piston Accumulator reference (lower) chamber is filled with process fluid. Ensure proper protective equipment is been worn before working with the accumulator.*

## **2 Safety**

### **2.1 Types of hazardous exposures**

The following hazards can be present in the N53C Piston Accumulator:

- High pressure
- Potential energy stored in compressed spring
- Dangerous toxic, caustic, or corrosive chemicals
- High temperature (hot surfaces and liquids)
- Moving parts

**NOTES:** Some components of the N53C piston accumulator are in contact with the process fluid. Make sure to use protective equipment adequate to the process fluid.

### **2.2 General safety**

When installing, operating, and maintaining the N53C Piston Accumulator, pay attention to safety:

- Obey applicable safety laws and regulations.
- Read and understand this manual.
- Follow the installation, operation, and maintenance procedures.
- Wear PPE as required and applicable.
- Take proper precautions and follow all plant requirements for handling hazardous materials.

### **2.3 Trained and qualified personnel**

Qualified personnel are people who have been authorized by those responsible for the safety of the plant to perform the necessary work, and who can recognize and avoid possible dangers. The following aspects determine the qualification of personnel:

- Appropriate training
- Relevant experience
- Knowledge of relevant standards and specifications
- Knowledge of accident prevention techniques and regulations
- Knowledge of plant regulations and operating conditions

### **2.4 Personal protective equipment (PPE)**

The N53C Piston Accumulator is often used for applications containing high-pressure, high-temperature and/or toxic chemicals. When operating or maintaining this device, make sure you wear the appropriate PPE, including protective clothing, gloves, safety shoes, safety glasses, hearing protection, etc.

Always follow local regulations regarding PPE.

### **2.5 Actions in extreme conditions**

In the unlikely event of emergency operating conditions always follow emergency plant regulations. Immediate evacuation of service personnel to be according plant regulations.

### 3 Environmental Considerations

**⚠ CAUTION:** *You are required by law to dispose waste products and end of life equipment, according to local regulations.*

#### 3.1 Disposing of waste products

Make sure waste products are diverted to a safe and suitable location. Always follow local and plant regulations.

Any waste products resulting from the use or maintenance of the N53C Piston Accumulator must be disposed of according to local environment laws and regulations.

#### 3.2 End-of-life equipment

**STOP** **WARNING – HAZARDOUS CHEMICALS:** *Dangerous chemical might be released during removal of the N53C Piston Accumulator. Wear PPE. Follow all safety regulations and Plant regulations.*

**STOP** **WARNING – HIGH PRESSURE:** *Take caution when de-pressurizing the N53C Piston Accumulator. The N53C Piston Accumulator might have energy stored inside. Make sure that de-pressurizing happens slowly.*

**STOP** **WARNING – HOT SURFACES:** *The N53C Piston Accumulator and surrounding surfaces might be hot. Take care when touching components. Wear the appropriate PPE, according to plant regulations.*

**NOTE:** End-of-life equipment must be disposed of according to local environment laws and regulations.

#### 4 Description

The N53C Piston Accumulator, which is displayed in Figure 1, is designed for usage in low pressure applications (<40Bar, 580 psi) to support the upgrade from a single seal to a dual seal to prevent dry running, control leakage/emissions and improve seal reliability in applications that where a Plan 53A could not be implemented. Where regular piston accumulators solely depend on the area difference of the piston to create an overpressure, the N53C Piston Accumulator is equipped with a spring that provides a minimal overpressure of 1.4 to 2.0 Bar (20 to 30 PSI) depending on the barrier fluid level. Additional to this overpressure the piston itself has a booster ratio of 1:1.04.

The N53C piston transmitter is designed according ASME B31.3. The barrier fluid level indication is done with the color code, which is visible from a further distance.

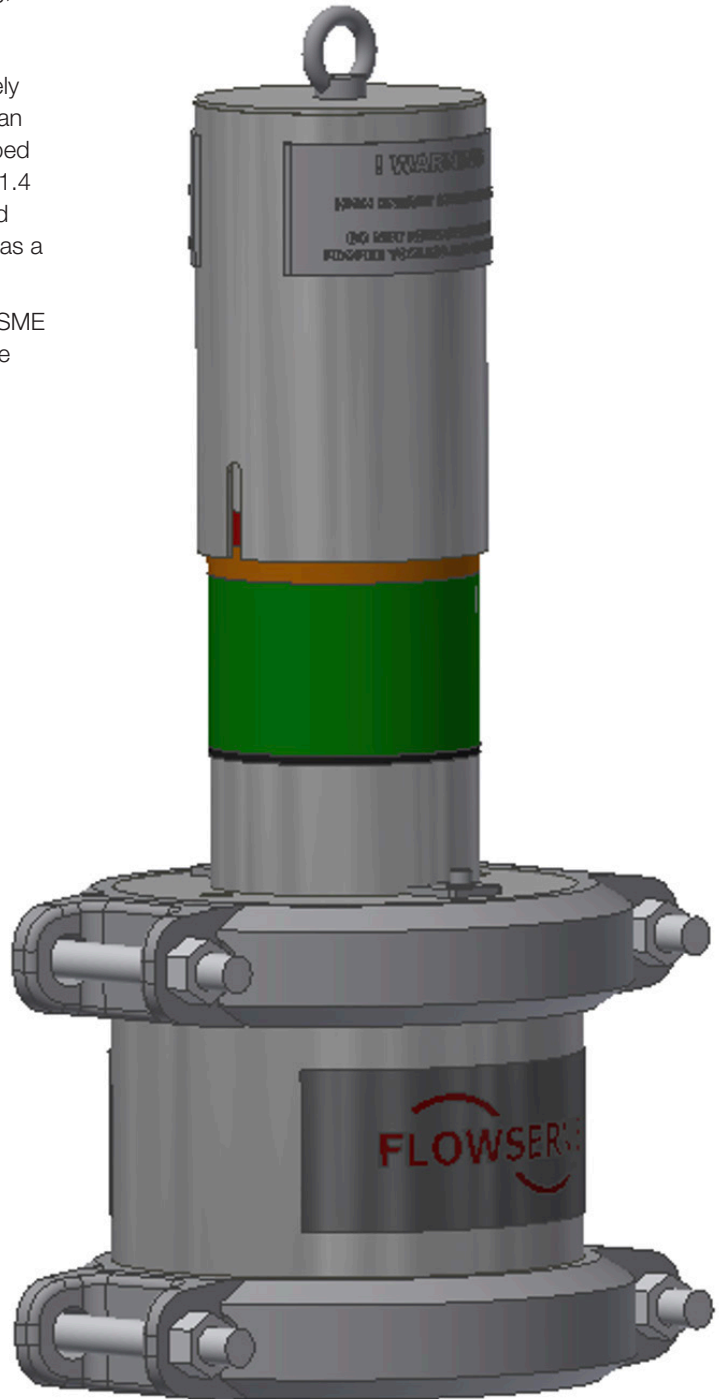

### 4.1 Product purpose

The N53C Piston Accumulator, displayed in Figure 1, is a piston accumulator. These products are pressure boosters, designed to create overpressure based on an impulse pressure. The N53C Piston Accumulator is designed for usage in low pressure Piping Plan 53C applications.

### 4.2 Design features

Operating conditions may vary but shall never exceed the design conditions. Refer to the attached drawing of the N53C Piston Accumulator for boundary dimensions, design conditions and operating constraints.

The key design features of the N53C Piston Accumulator are listed below:

- Meets ASME B31.3 design requirements
- Pressure Equipment Directive (PED) 2014/68/EU

### 4.3 Product components

The materials in which the standard N53C Piston Transmitter will be executed are listed below:

### 4.4 Operating principle

In a Piping Plan 53C, there is an external barrier fluid system pressurized by a piston accumulator supplying clean liquid to the barrier fluid seal chamber. The barrier liquid is maintained at a pressure greater than seal chamber pressure. The piping and instrumentation diagram (P&ID) is shown in figure 2. The Piston Accumulator is item 2. Items with key (\*) are optional (if specified).

**Table 1 – Component Materials**

| <b>Part</b>      | <b>Material</b>            |
|------------------|----------------------------|
| Cover top/bottom | 316 Stainless Steel        |
| Cover Spring     | 316 Stainless Steel        |
| Body             | 316 Stainless Steel        |
| Piston Disc      | 316 Stainless Steel        |
| Piston Shaft     | 316 Stainless Steel        |
| Clamps           | Galvanized Steel (Nitrile) |
| Level Indicator  | 316 Stainless Steel        |
| Coil Spring      | EN 10270-1 Epoxy coated    |
| Wear Bands       | PTFE                       |
| Gaskets          | Fluor elastomer            |



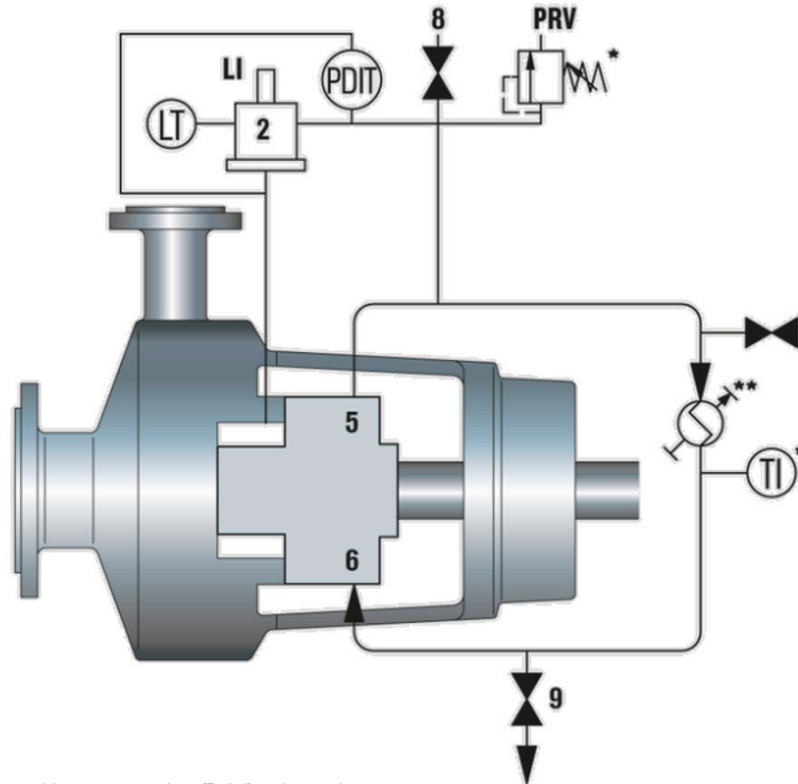

Figure 2 – Plan 53C piping and instrumentation (P & I) schematic

Plan 53Cs are used with an Arrangement 3 liquid seal. The piston accumulator senses pressure from a reference source (normally a line connected to the seal chamber) and creates a higher pressure. The generated overpressure shall be at least equal to the required pressure differential necessary for an Arrangement 3 seal. For low pressure applications the elevation in pressure caused just by the piston is not enough to create the required overpressure. Therefore, this Piston Transmitter is equipped with a spring. Figure 3 shows the section view of the N53C Piston Transmitter. In this section view it is shown how the spring is integrated in the design. In Figure 3, the piston is in its lowest level position. In this position the spring is already compressed to give an overpressure of 1.4 Bar (20 PSI). When the piston transmitter is being filled with barrier fluid and the piston moves to its high level position the spring will be compressed even more up till the point where it creates an overpressure of 2.0 Bar (30 PSI). The overpressure created by the spring combined with the overpressure created due to the booster ratio results in the barrier pressure the N53C Piston Transmitter will create. In Graph 1 is shown what the barrier pressure for different impulse pressures will be. In this graph the N53C Piston Accumulator is filled, which means the spring provides 2.0 Bar overpressure.

### 4.5 Identifying the product (type plate)

The materials in which the standard N53C Piston Transmitter will be executed are listed below:

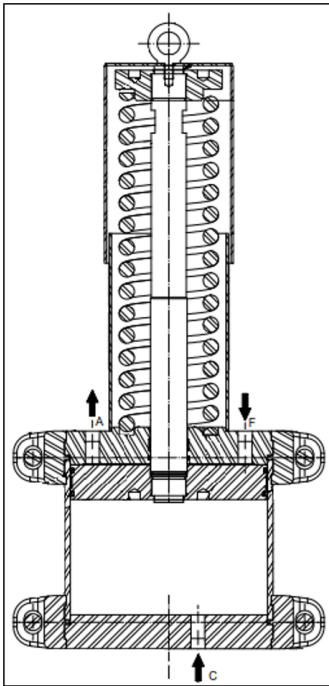
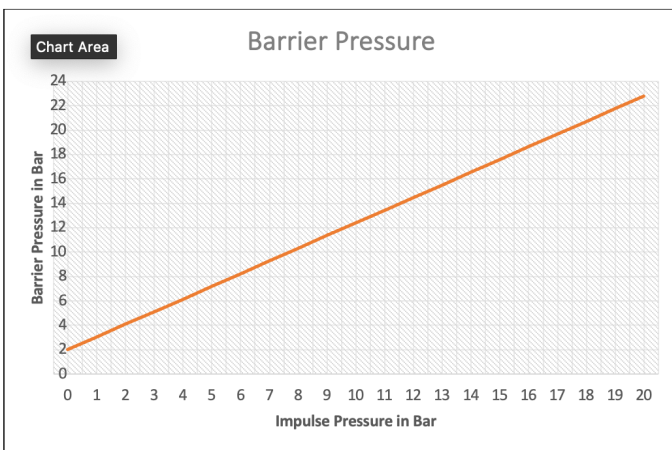

Figure 3 – Section view



Graph 1 – Barrier pressure based on impulse pressure

## 5 Preservation, Packing, Transport and Storage Requirements

### 5.1 Mechanical preservation instructions

#### 5.1.1 Preservation

Equipment should not be sealed in a way that it will obstruct inspection. Access for normal inspection and preservation maintenance shall be provided. Internal surfaces of pressure vessels, piping systems and similar equipment shall be dried and cleaned of surface corrosion and foreign material.

The N53C Piston Transmitter shall be thoroughly cleaned and dried after manufacturing and testing, prior to application of preservatives.

For equipment where water is used for cleaning or pressure testing, the water shall have antifreeze medium added unless the water is completely drained off. This also applies if the ambient temperature is below 4°C during any of these operations.

Internal surfaces wholly consisting of corrosion resistant materials shall not be preserved unless stated otherwise.

#### 5.1.2 Installation

For installation the applicable dust caps/plugs need to be removed prior to commissioning. During hook up it is mandatory to keep these caps/plugs in place for as long as possible to prevent contamination.

### 5.2 Packing

 **WARNING – CRUSH HAZARD: Possible injury and/or trapped limbs. Take care to avoid being trapped or crushed between heavy, moving objects when (un)boxing the cooler.**

The N53C Piston Transmitter is to be carefully lifted inside a timber box.

Always make sure that proper lifting devices are used.

To prevent damage during transport all equipment needs to be properly secured inside their timber package with suitable bolting, straps, or wooden supports.

For unboxing, the equipment must be lifted carefully out of its shipping box.

### 5.3 Transportation and storage requirements

**NOTE:** The following requirements apply to the N53C Piston Accumulator and all related equipment:

**Table 2 - Transport and Storage Criteria**

| Transport and storage criteria                 | Requirements   |
|--|--|
| Transportation                                 | The system must be transported and stored in the unopened, original shipping box.  |
| Suspect damaged during transportation          | Inspect N53C Piston Accumulator components that have been dropped or have been subjected to impacts during transport to confirm that they are operational before installation.                     |
| Warehouse requirements                         | The warehouse must be dry and dust free.   |
| Long-term storage                              | After a storage period of 2 years, inspect the N53C Piston Accumulator before installation.  |
| Preserving installed Piston Accumulator Series | The preserving medium prevents damage to the installed system or mechanical seal (i.e. preventing fouling or chemical attack). Contact Flowserve if you are unsure which preserving medium to use. |

## 6 Installation

### 6.1 Introduction

**STOP** **WARNING – CRUSH HAZARD: Possible injury and/or trapped limbs. Take care to avoid being trapped or crushed between heavy, moving objects.**

Before installing the N53C Piston Accumulator, make sure you have read and understood the installation requirements in this section. If you have any questions regarding the installation of the N53C Piston Accumulator, contact your local Flowserve representative.

### 6.2 Safety considerations

**STOP** **WARNING – CHECK BEFORE DISASSEMBLING: Under no circumstances should the N53C Piston Accumulator be disassembled while it still contains any hazardous materials or when it is pressurized.**

**X** **DANGER – SUFFOCATION HAZARD: Breathing hazardous chemicals in a confined space can result in sudden unconsciousness or death. Take extra care when working in confined areas.**

Position the N53C Piston Transmitter as close to your main equipment as possible. Make sure there is sufficient room for:

- Evacuation of the plant in case of an emergency (do not block walkways and emergency exits)
- Safe operation and maintenance of the system

If the N53C Piston Transmitter is being installed in a confined area, make sure there is adequate ventilation. Adequate ventilation is required for:

- Safe venting of the N53C Piston Accumulator interconnecting piping
- Sufficient airflow to enable cooling of the process media

### 6.3 Installation requirements

Before installation the following shall be checked:

- Any possible damage due to transport or storage
- Cleanliness, required before operation
- Existence of the nameplate with correct inspection markings and design/test conditions

## 6.4 Product set-up

### 6.4.1 Mounting

The N53C Piston Accumulator shall be installed in a vertical position. It has four M12 mounting holes in the bottom cover which shall be used to fix it to a stand. The dimensions of the mounting holes are displayed in Figure 4.

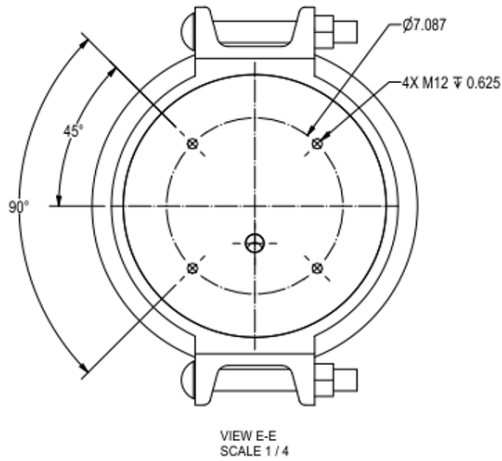

Figure 4 – Mounting holes

When the piston accumulator is used in combination with the standardized mounting bracket, four M12X20 bolts are provided to mount the piston accumulator to the mounting bracket. This is shown in Figure 5. The mounting bracket shall be fixed to a wall or a steel construction with a minimum of two M16 or 5/8 UNC bolts.

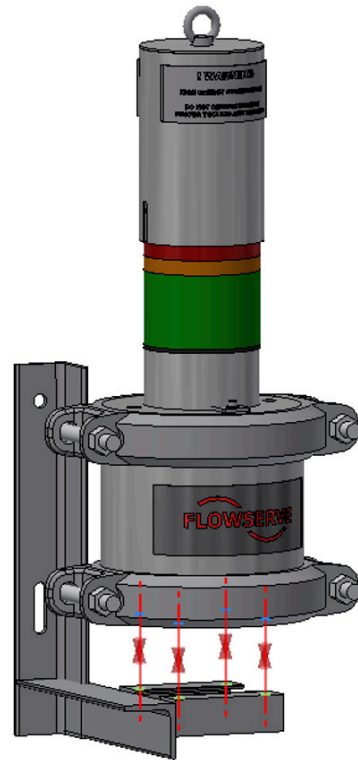

Figure 4 – Mounting holes

### 6.4.2 Connections

The N53C Piston Transmitter has three different end connection. These connections and their flow direction are visualized in Figure 3. Below is listed which connection has which function:

- “A”, This is the barrier connection. This connection contains the elevated pressure and shall be connected to the Piping Plan 53C.
- “C”, This is the Impulse connection. This connection shall be connected to the reference pressure source. Commonly, this reference pressure source is the seal chamber.
- “F”, This is the fill connection. This connection can be used to fill the piston transmitter with barrier fluid.

The location of connections “A” and “F” can be interchanged if this suits the layout of the application in which the N53C Piston Accumulator is used.

### 6.4.3 Interconnecting piping

A seal cooler can be added to the N53C to provide cooling of the barrier fluid when required. The flow of fluid through the seal cooler is either generated by:

- A pumping device, included in the seal design
- A circulation pump
- Thermosyphoning by natural convection

Barrier liquid is distributed through the system by means of an internal circulating device. To maximize barrier liquid circulation, the piping losses should be minimized through the proper selection of pipe size, elimination of fittings, use of large radius bends, and reduction in the length of piping runs.

Pay attention to the following points:

- Minimize the number of restrictions (for example, limit the number of elbow/tee fittings).
- Unless otherwise specified, the pipe size should be 0.75 in. and schedule shall be the same as the system piping.
- The pipes must be clean and free of burrs.
- The total pipe length and number of bends shall be kept to a minimum.
- Use smooth, large radius bends; do not use elbows, tees, etc.
- Pipe runs should be sloped continuously up or down to allow for adequate circulation, proper venting and draining.
- Make sure that the loop, including seal flange, does not include vapor traps. When vapor traps cannot be avoided, a proper venting solution shall be added.
- For threaded connections, do not use Teflon tape but an anaerobic thread sealant.
- Leak testing is recommended after assembly. Refer to end user specifications or procedures.

## 6.5 Installation procedure

Use this procedure to install or reinstall the system.

### Procedure

1. Before installing the N53C Piston Accumulator, inspect all components for damage. If any of the components are damaged, you should report this to your local Flowserve representative. Refer to section 6.3.
2. Determine the installed position of the system. Refer to the mounting requirements, section 6.4.1.
3. The N53C Piston Accumulator shall not be moved by hand. It is equipped with a lifting lug. Use an appropriate lifting device to position the N53C Piston Accumulator as close as possible to the main equipment. Make sure you leave sufficient room for operation and maintenance purposes.

 **WARNING – CRUSH HAZARD: Possible injury and/or trapped limbs. Take care to avoid being trapped or crushed between heavy, moving objects.**

4. Make sure that the N53C Piston Accumulator is installed in a rigid support to counteract any vibrations and instability.

 **WARNING – HIGH PRESSURE: Take caution when de-pressurizing the N53C Piston Accumulator. The N53C Piston Accumulator might have energy stored inside. Make sure that de-pressurizing happens slowly.**

5. Connect the N53C Piston Accumulator connections. Refer to section 6.4.2.
6. Manufacture the interconnecting piping according to the Installation requirement. Refer to section 6.4.3.

### NOTE:

- Leak testing is recommended after assembly. Refer to end user specifications or procedures.



## 7 Operation

### 7.1 Start-up

Use this procedure if:

- The N53C Piston Accumulator is being set up for the first time, or
- The barrier fluid has been completely drained from the system.

When the N53C Piston Accumulator is installed the application can be started up. The below procedure shall be used for starting up the N53C Piston Accumulator.

1. Make sure the N53C Piston Accumulator is installed correctly, refer to chapter 6.5.
2. Make sure the N53C Piston Accumulator is filled to the top of the black area on the volume indicator.  
Maximum fill volume indicated by the black area. Do not overfill. Over filling will lead to over pressurization of the Piston Accumulator.
3. Make sure commissioning of the system has been performed properly. Ensure that all the trapped gas/air is vented from the system and interconnecting piping.
4. Start up the pump according end user/plant procedures.

### 7.2 Product monitoring

 **WARNING – HIGH PRESSURE:** Take caution when de-pressurizing the N53C Piston Accumulator. The N53C Piston Accumulator might have energy stored inside. Make sure that de-pressurizing happens slowly.

 **WARNING – HOT SURFACES:** The N53C Piston Accumulator and surrounding surfaces might be hot. Take care when touching components. Wear the appropriate Personal Protection Equipment (PPE), according to plant regulations.

 **WARNING – HAZARDOUS CHEMICALS:** Hazardous chemicals might be released during removal of the N53C Piston Accumulator. Wear Personal Protective Equipment (PPE). Follow all safety regulations and Plant regulations.

Use this procedure to monitor the system:

1. Monitor the N53C Piston Accumulator for correct operation. Also refer to the Periodic maintenance tables in section 8.2.
2. Make sure:
  - There are no leaks
  - The seals and/or bearings are not running hot
  - There is no cavitation in the system
  - There is no heavy vibration in the system
3. If you notice any problems with the N53C Piston Accumulator, follow plant regulation for reporting and correcting faulty equipment.

N53C Piston Accumulator performance should be monitored periodically. Baseline temperatures should be collected soon after equipment commissioning.

### 7.3 Shut down product

 **WARNING – HIGH PRESSURE:** *Take caution when de-pressurizing the N53C Piston Accumulator. The N53C Piston Accumulator might have energy stored inside. Make sure that de-pressurizing happens slowly.*

 **WARNING – HOT SURFACES:** *The N53C Piston Accumulator and surrounding surfaces might be hot. Take care when touching components. Wear the appropriate PPE, according to plant regulations.*

 **WARNING – Hazardous chemicals might be released during removal of the N53C Piston Accumulator. Wear PPE. Follow all safety regulations and Plant regulations.**

The N53C Piston Accumulator may be disconnected only by qualified personnel, in accordance with national, plant- and end-user safety regulations and Chapter 2 in this manual.

Check if the N53C Piston Accumulator can be shut down. Check if the N53C Piston Accumulator can be de-pressurized without negatively affecting the mechanical seal installed in main equipment. System cannot be shut down if any of the following main equipment conditions occur:

- Main equipment/pump is on hot stand-by
- Main equipment/pump is pressurized
- Main equipment/pump is in operation

**NOTE:** Always shut down the system according to plant regulations/end user safety procedures.

## N53C Piston Accumulator

If the above points are checked, the N53C Piston Accumulator can be shut down according the procedure below:

- Make sure the pump is shut down according end-user/ plant regulations
- De-pressurize the impulse side of the N53C Piston Accumulator
- Drain the impulse side of the N53C Piston accumulator.
- De-pressurize the barrier side of the N53C Piston Accumulator
- Drain the barrier side of the N53C Piston accumulator.

**NOTE:** For (re)-installation, removal and maintenance work, the N53C Piston Accumulator must be de-pressurized (and drained if required).

## 8 Maintenance

### 8.1 General guidelines

Periodic maintenance must be done at regular intervals (weekly, monthly, yearly). Refer to the following tables.

All liabilities and warranties to Flowserve for damage incurred using non-original replacement parts and accessories will be rendered null and void.

### 8.2 Periodic maintenance tables

Use the following tables to plan the periodic maintenance for your system (refer to the table of contents and the Appendix for the relevant information).

**Table 3 - Periodic Maintenance Tables**

| Weekly maintenance  |
|---|
| Check the seal, N53C Piston Accumulator, and interconnecting pipe work for leaks. Rectify if necessary.   |
| Check if the N53C Piston Accumulator is not sliding.  |
| Check the pressures of both barrier and impulse side.   |
| Check the level of the Piston Accumulator. Make sure to refill if necessary. Maximum fill volume indicated by the black area. Do not overfill. Over filling will lead to over pressurization of the Piston Accumulator. |
| Monthly maintenance   |
| Do all weekly periodic maintenance procedures.  |
| Check the fluid for impurities.   |
| Vent the N53C Piston Accumulator interconnecting pipe lines.  |
| Yearly maintenance  |
| Do all weekly and monthly periodic maintenance procedures.  |

### 8.3 Inspection procedure

**STOP** **WARNING – HIGH PRESSURE:** Take caution when de-pressurizing the N53C Piston Accumulator. The N53C Piston Accumulator has energy stored inside. Disassembling the spring of the piston accumulator shall only be performed by trained and authorized personnel who have access to the right auxiliary tools.

**STOP** **WARNING – HOT SURFACES:**The N53C Piston Accumulator and surrounding surfaces might be hot. Take care when touching components. Wear the appropriate PPE, according to plant regulations.

**STOP** **WARNING – HAZARDOUS CHEMICALS:** Hazardous chemicals might be released during removal of the N53C Piston Accumulator. Wear PPE. Follow all safety regulations and Plant regulations.

The product maintenance procedure is as follows:

- Remove the N53C Piston Accumulator from service. Refer to section 7.3, Shut down product.
- Disassemble the top clamp of the N53C Piston Accumulator and lift the complete piston including top cover out of the body.
- Clean the piston and the piston body internally and externally.
- Check and possibly exchange the gaskets and wear rings on the outer diameter of the piston disc.
- If there is any visible leakage along the piston rod, the top part of the piston accumulator needs to be disassembled to check and possibly replace the gasket and wear ring of the shaft.

Disassembling the spring assembly of the piston accumulator shall only be performed by trained and authorized personnel who have access to the proper tooling.

- Inspect all components for damage or corrosion and replace as needed.
- Re-install the N53C Piston Accumulator. Refer to section 6.5, Installation procedure.

## 9 Troubleshooting

Use the following table to troubleshoot the system. Once you have identified the problem, use the procedures in this manual to maintain the N53C Piston Accumulator. If you are not sure how to troubleshoot or maintain your N53C Piston Accumulator, please contact your local Flowserve representative.

**NOTE:** the recommended response actions always include notify the supervisory authority and respond according plant regulation.

**Table 4 - Localization and Elimination of Vaults, Damages and Their Consequences**

| Parameter | Indication | Possible cause  | Solution  |
|-----------|------------|---|---|
| Pressure  | Low        | <ul style="list-style-type: none"> <li>Leakage in connections, gaskets, piping</li> <li>Mechanical seal failure</li> <li>Internal leakage between impulse and barrier side</li> </ul> | <ul style="list-style-type: none"> <li>Check connections for leakage</li> <li>Check gaskets for leakage</li> <li>Check piping for leakage</li> <li>Check mechanical seal</li> </ul> |
| Pressure  | High       | <ul style="list-style-type: none"> <li>Process discharge closed</li> </ul>  | <ul style="list-style-type: none"> <li>Open discharge line</li> </ul>   |



## ANNEX II

*Page is left blank intentionally*



**Flowserve Corporation**

No. 35, Baiyu Road  
Suzhou Industrial Park  
Suzhou 215021, Jiangsu Province, PRC  
Phone: +86-512-6288-1688  
Fax: +86-512-6288-8737

**Flowserve Pte Ltd.**

No. 12 Tuas Avenue 20  
Singapore 638824  
Phone: +65 6879 8900  
Fax: +65 6862 4940

**Flowserve Corporation**

Flow Control Division  
1978 Foreman Drive  
Cookeville, Tennessee 38501 USA  
Phone: +1-931-432-4021  
Fax: +1-931-432-5518

**Flowserve Corporation**

Flow Control Division  
1350 North Mountain Springs Parkway  
Springville, Utah 84663-0913 USA  
Phone: +1-801-373-3028  
Fax: +1-801-489-2228

**Flowserve Flow Control (UK) Ltd.**

Burrell Road  
Haywards Heath  
West Sussex United Kingdom  
RH16 1TL  
Phone: +44-1444-314400  
Fax: +44-1444-314401

**Flowserve Ahaus GmbH**

von-Braun-Str. 19a  
48683 Ahaus  
Phone: +49-2561-686-119  
Fax: +49-2561-686-109

**Flowserve Flow Control GmbH**

Actuators and Automation Center  
Germany  
Rudolf Plank Str. 2  
D-76275 Ettlingen  
Germany  
Phone +49 (0)7243-103-0  
Fax +49 (0)7243-103-222

**Flowserve Flow Control Benelux BV**

Rechtzaad 17  
4703 RC Roosendaal NB Netherlands  
Phone: +31-165-598-800  
Fax: +31-165-555-670

**Flowserve India Controls Pvt Ltd.**

Plot No. 4, 1A, E.P.I.P, Road No. 8  
Whitefield, Bengaluru  
Karnataka 560066, India

**Flow Control Division Brazil**

Rua Tocantins, 128  
09580-130 - São Caetano do Sul - SP  
Brazil

**Headquarters**

Flowserve Corporation  
5215 North O'Connor Blvd.  
Suite 700  
Irving, Texas 75039-5421 USA  
Telephone: +1-937-890-5839

Flowserve Corporation has established industry leadership in the design and manufacture of its products. When properly selected, this Flowserve product is designed to perform its intended function safely during its useful life. However, the purchaser or user of Flowserve products should be aware that Flowserve products might be used in numerous applications under a wide variety of industrial service conditions. Although Flowserve can provide general guidelines, it cannot provide specific data and warnings for all possible applications. The purchaser/user must therefore assume the ultimate responsibility for the proper sizing and selection, installation, operation, and maintenance of Flowserve products. The purchaser/user should read and understand the Installation Instructions included with the product, and train its employees and contractors in the safe use of Flowserve products in connection with the specific application.

While the information and specifications contained in this literature are believed to be accurate, they are supplied for informative purposes only and should not be considered certified or as a guarantee of satisfactory results by reliance thereon. Nothing contained herein is to be construed as a warranty or guarantee, express or implied, regarding any matter with respect to this product. Because Flowserve is continually improving and upgrading its product design, the specifications, dimensions and information contained herein are subject to change without notice. Should any question arise concerning these provisions, the purchaser/user should contact Flowserve Corporation at any one of its worldwide operations or offices.

©2022 Flowserve Corporation. All rights reserved. This document contains registered and unregistered trademarks of Flowserve Corporation. Other company, product, or service names may be trademarks or service marks of their respective companies.

**SSIOM000745-00 (EN/A4)** November 2022