



USER INSTRUCTIONS

Submersible Water Well Pumps

*Byron Jackson H2O Submersible Pumps and Motors
(Water filled)*

**Installation
Operation
Maintenance**

PUIOM000992-EN

Original Instructions

 ***These instructions must be read prior to installing, operating, and maintaining this equipment.***



Experience In Motion



Copyright

All rights reserved. No part of these instructions may be reproduced, stored in a retrieval system or transmitted in any form or by any means without prior permission of Flowserve Corporation.

Document Version

Initial Release, 13-JAN-2023

Current Release, 13-JAN-2023



CONTENTS

1	General Information	4
1.1	Scope of manual	4
1.2	Disclaimer	4
1.3	Symbol explanation	5
1.4	Certification	5
1.5	Units	5
2	Safety Information	5
2.1	Intended use	5
2.2	Safety symbols and description	6
2.3	General hazard sources	7
2.4	Responsibility of the operator of the equipment	8
2.5	Qualified personnel and targeted group	8
2.6	Industrial health and safety measures	8
2.7	Potential explosive areas	9
2.8	Protective equipment	9
3	Product Description	9
3.1	General product description	9
3.2	Design and Function Description	11
3.3	Connections	14
3.4	Controls	14
3.5	Accessories	18
4	Packaging, Transportation and Storage	18
4.1	Receipt and Unpacking	18
4.2	Transportation	19
4.3	Storage	21
5	Installation	23
5.1	Inspection and preparation	23
5.2	Installation	24
5.3	Impeller Lift Requirement	30
5.4	Connecting Pump to Motor	34
5.5	Installation after pump and motor have been assembled together	35
6	Commissioning	36
6.1	Safety instructions	36
6.2	General notes	37



6.3 Connection to starter/controller.....37

6.4 Starting the pump38

7 Operation.....42

7.1 Normal Operation.....42

7.2 Shut-down.....46

8 Trouble Shooting47

9 Appendix.....49

1 General Information

1.1 Scope of manual

 These instructions must be kept close to the product's operating location or directly with the product.

 These instructions must be read prior to installing, operating, using, or maintaining the equipment in any region worldwide. The equipment must not be put into service until all the safe operating conditions noted in the instructions have been met. *Failure to comply with the information provided in the User Instructions is considered misuse. Personal injury, product damage, delay in operation, or product failure caused by misuse are not covered by the Flowserve warranty.*

Flowserve products are designed, developed and manufactured with state-of-the-art technologies in modern facilities. The unit is produced with great care and commitment to continuous quality control, utilizing sophisticated quality techniques, and safety requirements.

Flowserve is committed to continuous quality improvement and being of service for any further information about the product with its installation and operation or about its support products, repair and diagnostic services.

Byron Jackson H2O Submersible Pumps and Motors (water-filled)

These instructions are intended to familiarize the reader with the product and its permitted use. Operating the product in compliance with these instructions is important to help ensure reliability in service and avoid risks. These instructions may not reflect all local regulations; ensure all local regulations are observed by all, including those installing the product. Always coordinate repair activities with operations personnel and follow all plant safety requirements and applicable safety and health legislation.

1.2 Disclaimer

Information in this User Instruction is believed to be complete and reliable. Despite all Flowserve's efforts to provide comprehensive information and instructions, sound engineering and safety practices should always be used. Please consult with a qualified engineer.

Flowserve manufactures products to applicable International Quality Management System Standards as certified and audited by external Quality Assurance organizations. Genuine parts and accessories have been designed, tested, and incorporated into the products to help ensure continued product quality and performance in use. As Flowserve cannot test parts and accessories sourced from other vendors, the incorrect incorporation of such parts and accessories may adversely affect the performance and safety features of the product. The failure to properly select, install, or use authorized Flowserve parts and accessories is considered misuse. Damage or failure caused by

misuse is not covered by Flowserve's warranty. In addition, any modification of Flowserve products or removal of original components may impair the safety of these products in use.

1.3 Symbol explanation

Information: This symbol indicates a recommendation and important information when handling the pump.

Note:

This sign is not a safety symbol but indicates an important instruction in the assembly process. Safety symbols are explained in section 2.2

1.4 Certification

Flowserve submersible products are certified to ANSI / NSF 61 for potable water service

1.5 Units

Both US Customary and Metric system units may be utilized in the document.

2 Safety Information

2.1 Intended use



The product/system must not be operated beyond the parameters specified for the application. If there is any doubt as to the suitability of the product/system for the application intended, contact Flowserve for advice, quoting the serial number.

- Installing, operating, or maintaining the product/system in any way that is not covered in this User Instruction could cause death, serious personal injury, or damage to the equipment. This includes any modification to the product/system or use of the parts not provided by Flowserve.
- Only operate the product/system when it has successfully passed all inspection acceptance criteria.
- Do not operate the product/system in a partially assembled condition.
- If the condition of service changes (i.e., pumping fluid, temperature, or duty conditions) it is requested that the user seeks written agreement from Flowserve before start-up.
- Observe equipment labels, such as arrows designating the direction of rotation, warning signs, etc., and keep them in a legible condition. Replace any damaged and/or illegible labels immediately.
- Do not use or install this equipment in areas considered or classified as hazardous locations such as areas where flammable liquids, gases, vapours or combustible dusts exist in quantities to produce an explosion or fire.
- Catastrophic or fatal electric shock may result from failure to connect motor controller, metal plumbing, and all other metal near the motor or cable to the power supply ground terminal, using

a wire size and connector complying with local regulations. To reduce the risk of electrical shock, disconnect power before working on or around the water system.

- Do not install this pumping system in areas used for swimming

2.2 Safety symbols and description

This User Instruction contains specific safety markings where non-observance of an instruction would cause a hazard. The specific safety markings are:

Table2.2.a: Definition of safety symbols and markings









Symbol	Description
	DANGER This symbol indicates a hazardous situation which, if not avoided, will result in death or serious injury
	WARNING This symbol indicates a hazardous situation which, if not avoided, could result in death or serious injury
	CAUTION This symbol indicates a hazardous situation which, if not avoided, could result in minor or moderate injury
	Safety Instruction This symbol indicates specific safety-related instruction or procedures
	NOTICE This symbol is used to address practices not related to physical injury
	This is the safety alert symbol. It is used to alert you to potential physical injury hazards. Obey all safety messages that follow this symbol to avoid possible injury or death.

Table 2.2.b: Additional symbols

Symbol	Description
	ELECTRICAL HAZARD This symbol indicates electrical safety instructions where non-compliance would affect personal safety and could result in loss of life
	TOXIC HAZARD This symbol indicates “hazardous substances and toxic fluid” safety instructions where non-compliance would affect personal safety and would damage the equipment or property
	ATEX EXPLOSION PROTECTION This symbol indicates explosive atmosphere marking according to ATEX. It is used in safety instructions where non-compliance in the hazardous area would cause the risk of an explosion

2.3 General hazard sources

2.3.1 Mechanical Hazards

a) Lifting limits and guidelines

Note: The load values mentioned in this section are Flowserve guidelines only. All lifting must be done in compliance with site safety protocol, local regulations, and related industry standards.

Many precision parts have sharp corners which require appropriate personal protective equipment during handling. Prior to any attempt to lift an item, employees must first determine the approximate weight and stability of the load.

- *Large, unstable, or awkward loads should always be handled with the assistance of additional personnel or appropriate mechanical means.*
- *Loads in excess of 23kg (50 lb.) should only be lifted by appropriate mechanical means and in accordance with current local legislation or with the assistance of additional personnel.*
- *Lifting items less than 23kg (50 lb.) may be prohibited without assistance if the lift is repetitive and/or awkward (i.e., away from the body, above the shoulders or below the knees) thus placing excessive stress on the personnel.*
- *Repetitive lifting of any kind should be evaluated as part of a documented end-user safety program.*



2.3.2 Electrical hazards

Protective measures against shock-hazard voltages must be taken according to applicable local and national regulations and the local electric power company requirements.

In most districts, the ground conductor must be connected directly to the motor on new systems. This also applies when the unit is installed in an inaccessible well.

	 DANGER
	<p>NEVER DO MAINTENANCE WORK WHEN THE UNIT IS CONNECTED TO POWER</p>

2.3.3 Insulation Resistance Testing (Megohm Test)

	 DANGER
	<p>NEVER CONDUCT THIS TEST IN AN AREA THAT HAS BEEN DESIGNATED AS A HAZARDOUS LOCATION ONLY CONDUCT THIS TEST ON OTHERWISE NON-ENERGIZED EQUIPMENT</p>

2.4 Responsibility of the operator of the equipment



- Complete a risk assessment of the site where the product/system will be in operation, by observing the working conditions.
- Create site specific work instructions for the operation of the product
- Ensure that the personnel have read and understand all applicable instructions
- Provide regular training to the necessary personnel in regular intervals
- Provide the required personal protective equipment

2.5 Qualified personnel and targeted group

All personnel involved in the operation, installation and maintenance of the unit must be qualified to carry out the work involved. If the personnel in question does not already possess the necessary knowledge and skill, appropriate training and instruction must be provided. If required, the operator may commission the manufacturer / supplier to provide applicable training.

Always co-ordinate repair activities with operation and health and safety personnel.

Follow all plant safety requirements and applicable safety and health laws and regulations.

	 DANGER
	<p>All work on the electrical system may only be performed by qualified electricians! All work on the hydraulic connections may only be performed by qualified fitters.</p>

2.6 Industrial health and safety measures

Follow industry safety standards including the use of appropriate equipment in required areas.

2.7 Potential explosive areas



This equipment is not rated to operate in potential explosive areas.

2.8 Protective equipment

During transportation, installation and removal of the pumping unit, all personal must wear

- *Helmet/ hard hat*
- *Safety tools*
- *Protective gloves*
- *Other Personal Protective Equipment as prescribed by local regulatory requirements*

3 Product Description

3.1 General product description

The Byron Jackson H2O submersible motor and pumping unit is a combination of

- *a vertical pump bowl assembly*
- *a water filled electric submersible motor*

Designed for sustained operation submerged in water, the motor is positioned directly below the pump bowl assembly. The rotating element of the pump bowl assembly is driven from the bottom where its extended shaft is connected to the motor shaft by a coupling. Power is supplied to the motor through a submarine power cable which is fastened to the riser pipe and extends to the starting equipment. Motor and pump bowl assembly are connected to the riser pipe. The riser pipe is threaded or flanged and coupled in random lengths and the entire unit is coupled to a wellhead assembly.

Each pumping unit has been individually manufactured according to the special requirements of the customer. The technical data is given in Section 9 "Technical Data".

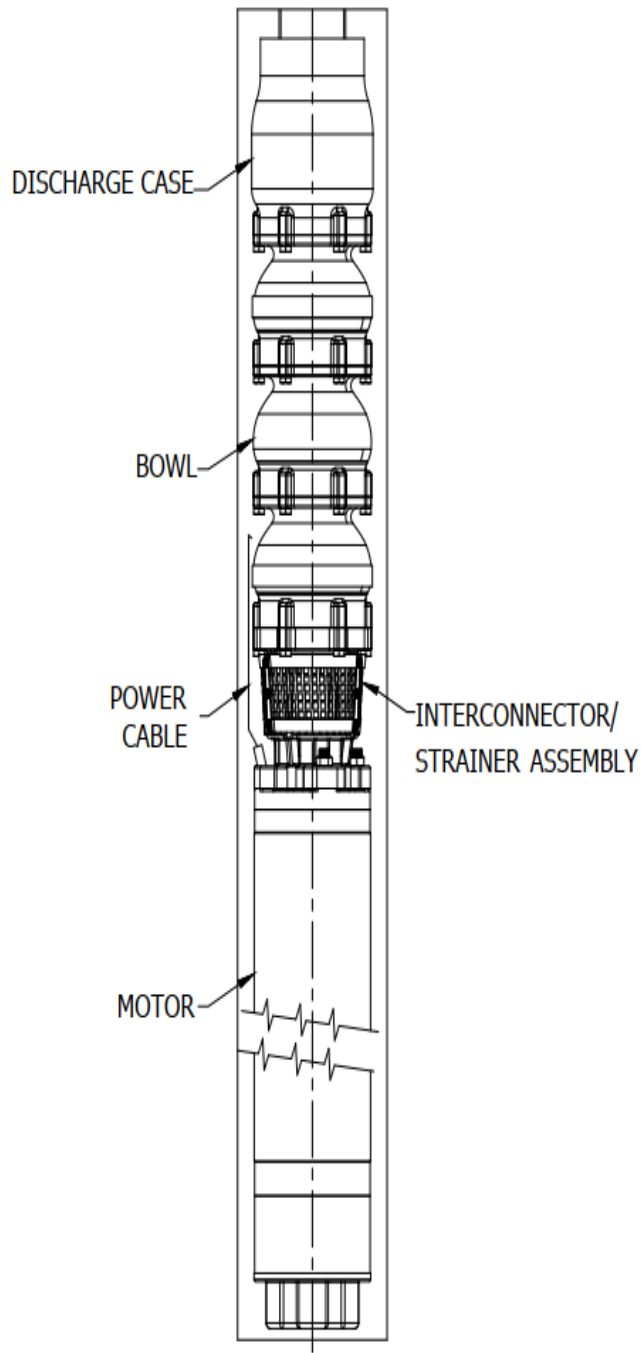

Figure 3.1: Submersible Pump and Motor Assembly

3.2 Design and Function Description

A pumping unit consists of

- *Motor*
- *Pump bowl assembly*
- *Non-Return Valve*
- *Power cable*
- *Discharge tubing or column or riser*
- *Cable banding or brackets to fasten the motor power cable onto the riser pipe*

NOTE: Not all components or sub-assemblies of a pumping unit are necessarily supplied by Flowserve or part of this delivery. These user instructions apply only to the components or sub-assemblies supplied by Flowserve in this delivery.

Motor

The electric motor is a water-filled three-phase AC squirrel-cage motor with a watertight winding, which is operating in water and is designed especially for direct drive of submersible pumps. The motor filling-water cools the winding and bearings as well as lubricating the thrust and radial bearings.

The submersible-motor-pump is connected to the lower end of a riser pipe and submerged in the pumped medium. The power supply is through submersible power cables fastened to the riser pipes with cable clips.

Interconnector

One of the main components of the pumping system in which one side of the interconnector is connected to the bowl assembly and other side is used to mount the motor. The interconnector also serves as the suction of the pumping system and strainer is mounted to the interconnector.

Pump Bowl

The bowl(s) contain passageways to transfer the liquid between the outside diameter of the preceding impeller and the eye of the subsequent impeller. Pump bowl assembly consists of impeller mounted on the shaft with collet and wear ring fitted to bowl. Each pump bowl stage has a sleeve bearing to support the pump shaft.



Non-return or check valve

A non-return valve is used to avoid the flow back to the pump from piping system which in turn eliminates the rotation of pump in reverse direction when the unit is shut down, protecting the motor thrust bearing. If one or more vertical riser pipe check valves are to be used on an installation, each valve, which should have a bleed-back self-draining feature, will take the place of a riser pipe coupling. The non-return valve is only supplied by Flowserve if specifically requested and included in the scope of supply.

The recommended installation is as follows:

- One valve:

Locate the valve approximately 23 m (75 feet) above the pump bowl assembly.

- Two valves:

Locate the first valve 30 m (100 feet) above the pump bowl assembly. Locate the second valve at 3/5 of the distance between first valve and the surface support plate.

Power Cable

The submersible power cable is constructed to operate in a submersed and wet environment and supply power to the motor. The cable is spliced to the motor leads with waterproof materials and is affixed to the riser piping up to the surface and connected to either a junction box or the controller. Proper sizing of the cable is required to ensure adequate voltage is supplied to the motor and to ensure the cable does not over heat. The installing Electrician has final responsibility of the correct cable sizing according to relevant local regulations.

Riser pipe

Riser pipe is also called discharge tubing or column pipe. The riser pipe is not typically supplied by Flowserve. It can be constructed in numerous forms such as steel piping, PVC piping, flexible tubing, etc. Riser pipe is assembled to the non-return valve or top pump bowl and the entire submersible pump/motor assembly is suspended from this riser pipe.

Cable bands or brackets

The cable bands or brackets are used to mount the power cable from motor onto the riser/discharge pipe.

Auxiliary Equipment

Other equipment may be used or required depending upon the specific requirements of local regulatory authorities, well design, and system requirements.

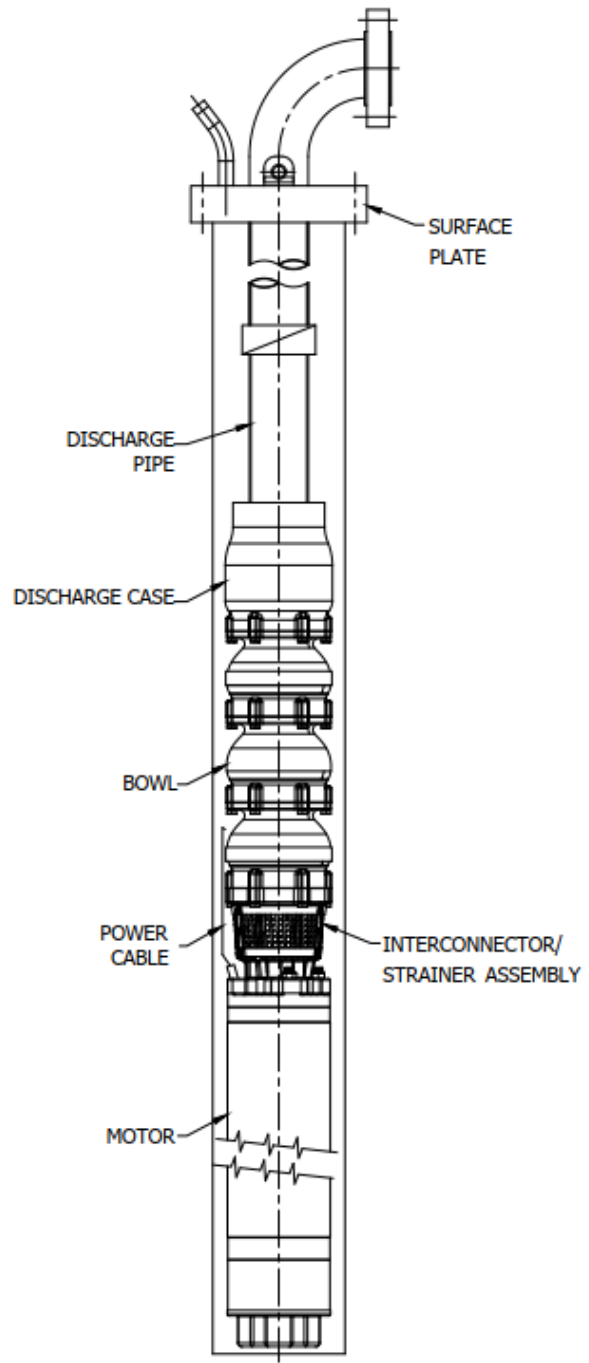

Figure3.2: Diagram of Typical Water Well System

3.3 Connections

3.3.1 Electrical connections



Electrical connections must be made by a qualified Electrician in accordance with relevant local, national and international regulations.



It is important to be aware of the EUROPEAN DIRECTIVE on potentially explosive areas where compliance with IEC60079-14 is an additional requirement for making electrical connections.



It is important to be aware of the EUROPEAN DIRECTIVE on electromagnetic compatibility when wiring up and installing equipment on site. Attention must be paid to ensure that the techniques used during wiring/installation do not increase electromagnetic emissions or decrease the electromagnetic immunity of the equipment, wiring or any connected devices.



The motor must be connected in accordance with the requirements in this manual and the local governing electrical codes. The nameplate should be checked to ensure the power supply is appropriate.

3.4 Controls

3.4.1 General remarks

Installation of lightning arrestors is recommended to protect the control panel, motor cables and the motor. Any failure due to lightning is not covered by warranty.

Reduced voltage starting using soft starters, autotransformers, variable speed drives, star delta starters (if motor is provided with 6 leads), etc. require additional care to ensure the motor is not subjected to additional problems. Please ensure compliance with the following:

- Overload settings and breakers must be sized appropriately and properly set to protect the motor. The starter must allow the motor to accelerate the pump with sufficient torque to allow it to reach full speed as quickly as possible. The motor must be up to full speed in 3 seconds. Failure to do so will cause overheating of the motor and/or thrust bearing wear.
- Ensure the voltage reaches full voltage within 3 seconds. Operation at reduced voltage for longer than a few seconds will cause the motor to overheat and fail.



3.4.2 Inverters

- 1) *Inverters are referred to by different names including Variable Speed Drive (VSD), Variable Frequency Drive (VFD), Adjustable Speed Drive (ASD), or Adjustable Frequency Drive (AFD)), Variable Voltage Variable Frequency controllers (VVVF) Inverters are controllers with the ability to vary the speed of the submersible pumping unit. The ability to change speed provides more flexibility for operating the pump at a variety of conditions. With this ability, extra care must be taken to ensure proper system configuration and operational controls.*
 - a. *Accurate and calibrated quick trip overload settings should be set to trip if any phase exceeds the safety factor full load current.*
 - b. *A constant ratio of V/Hz must be maintained (7.67 for 460 V, 60 Hz and 380 V, 50 Hz motors)*
 - c. *Minimum operating frequency should be 30 Hz for short periods but for normal operation, it should be above 42 Hz for 60 Hz nameplated motors and 35 Hz for 50 Hz nameplated motors. This is for protection of all bearings and because most submersible applications require a certain speed to lift water to the surface. If no water is lifted to the surface, there will not be any cooling flow over the motor and the motor will overheat and fail.*
 - d. *Maximum Run-Down time to Power Off shall not exceed 4 seconds. Coast down stopping instead of ramping down is preferred to avoid temporary voltage increases resulting from the VVVF generator mode if the motor is decelerated too fast.*
 - e. *Maximum operating frequency is nameplate frequency.*
 - f. *Motor should be ramped up to at least 35 Hz within 4 sec*
 - g. *Dynamic braking options on the inverter should be disabled. Actively attempting to brake the motor could cause shaft breakage, voltage spikes and other motor issues.*
 - h. *Direct torque control algorithms and settings are not recommended for drive control. These algorithms are used in applications where very precise speed control is required. Centrifugal pumps do not need this precise speed control and in fact if this setting is enabled, can potentially cause fatigue and damage to the pump and/or motor shaft.*
 - i. *Voltage boost during starting is permitted in order to ensure a rapid acceleration time to minimum speed in the required time.*
 - j. *The inverter switching frequency should be as per the inverter manufacturer's recommendations for non-dynamic loads such as pumps. Direct Torque Control or other similar operating schemes are not allowed as they can cause fatiguing of shafts and shaft failure.*
 - k. *Most modern inverters use IGBT's which can present rapidly peaking high voltage spikes that can stress the motor insulation windings. These peaks can be exacerbated by long cables typically used in submersible applications. Flowserve strongly recommends the use of an output filter to protect the motor insulation.*
 - l. *Grounding should be in compliance with the drive manufacturer's recommendations plus local regulatory requirements. Failure to adequately ground the motor presents the potential erosion/corrosion of the pump and motor due to current loops unable to be handled in the ground circuit.*
 - m. *Care must be taken to ensure adequate flow velocity past the motor as changing speeds could drastically drop the velocity.*

3.4.3 Motor connection Diagrams

Clockwise rotation

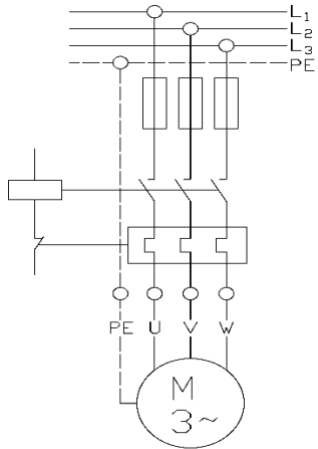

Direct-on-line-starting-delta power supply cable

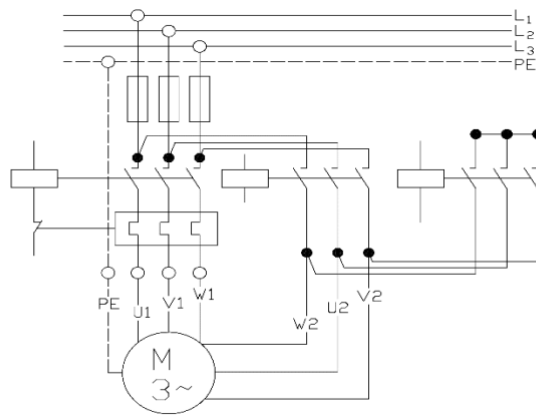

Direct-on-line-starting - one connection in control panel

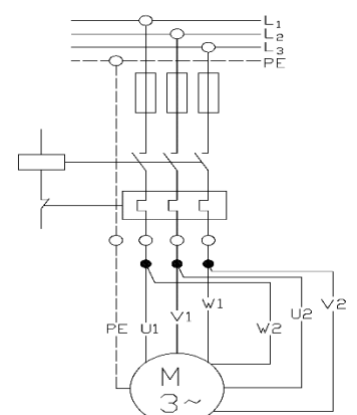

Star-delta-starting connection in control panel

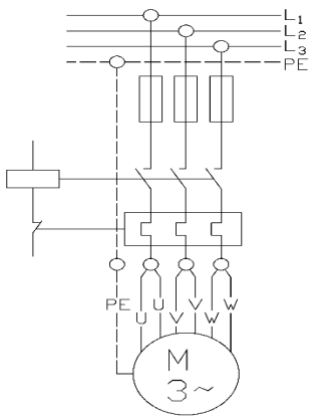

Direct-on-line-starting - two power supply cable

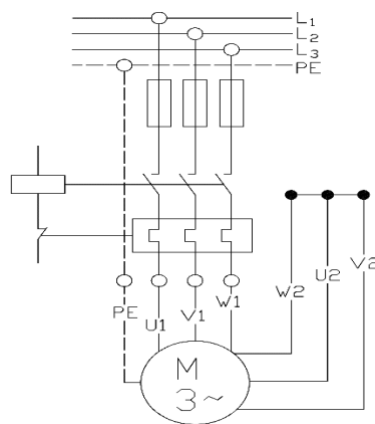

Direct-on-line-starting-delta connection in control panel

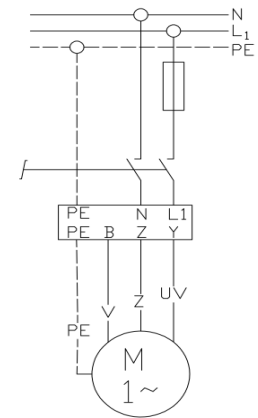

Single-phase motor connection in control panel

Counter-Clockwise rotation

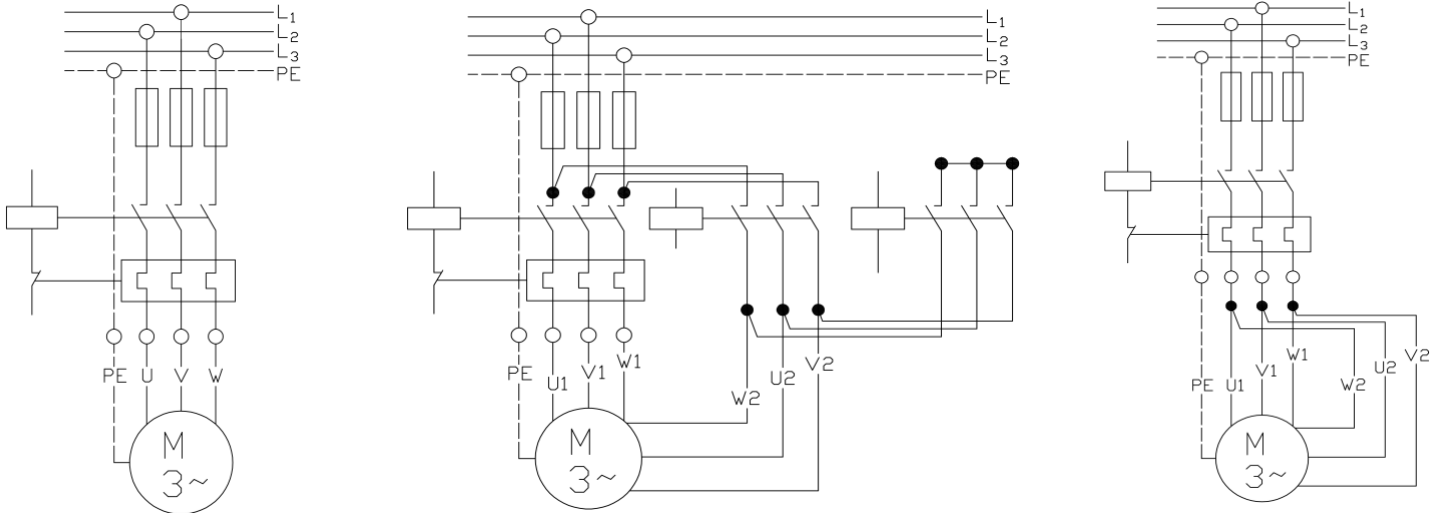

Direct-on-line-starting – one power supply cable

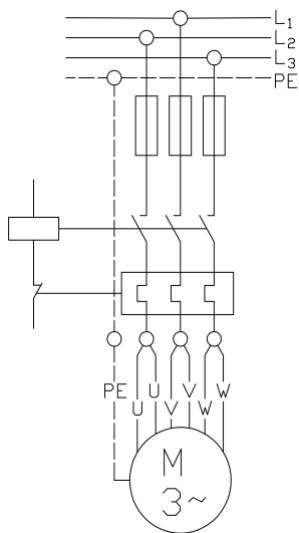

Star-delta-starting

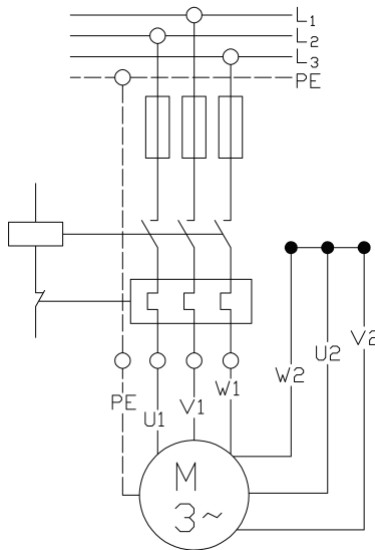

Direct-on-line-starting-delta connection in control panel

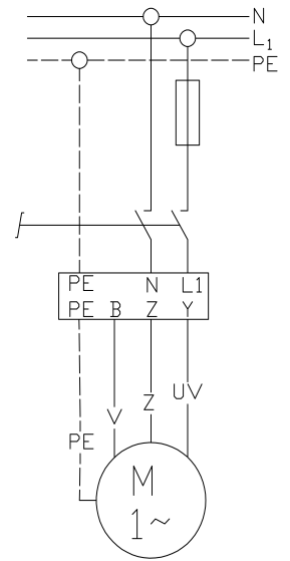

Direct-on-line-starting – two power supply cable

Direct-on-line-starting-delta connection in control panel

Single-phase motor

3.5 Accessories

If your submersible motor is provided with temperature monitoring, the PT100 probes should be connected to a temperature monitor. The instrument leads will require an additional instrument cable to the surface. The temperature limits should be set at 158°F (70°C) or below to maintain a safety margin for the insulation winding temperature limits. Records should be maintained of temperature and any rise in temperature should be investigated to understand the cause for the rise.

4 Packaging, Transportation and Storage

4.1 Receipt and Unpacking

Submersible pumps are subjected to a thorough inspection before leaving the factory and are supplied with operating instructions for fitting, starting, care etc, that conform to international safety regulations.



During all aspects of handling, transportation and installation, the unit must be protected from mechanical shock to prevent damage to the components.



Immediately after receipt of the equipment, check the delivery/shipping documents for completeness of the shipment and verify there has been no damage in transportation. Any shortage and/or damage must be reported immediately to Flowserve.

Check any crates, boxes and wrappings for any accessories or spare parts that may be packed separately with the equipment or attached to side walls of the box or equipment.

Each product has a unique serial number. Check that this number corresponds with that advised and always quote this number in correspondence as well as when ordering spare parts or further accessories.

4.1.1 Handling and lifting

	 CAUTION
	<p>Take special care when handling the pump unit. Make certain that it does not impact against walls, steel structures or floors etc.</p> <p>Under no circumstances must the power cables be used for lifting or moving the motor.</p>

	 CAUTION
	<p>Do not lift heavy equipment overhead of personnel.</p>

A safe distance must be kept when lifting and moving the equipment.
Use approved and suitable lifting equipment only.

The height of the lifting equipment should be such that the pump and motor are able to be lifted in vertical position.



Do not attempt to lift the pump or motor using eyebolts on pump/motor components as this could damage sealing and machined fit surfaces.

Do not remove the protection cover from the pump discharge until installation in the well as it prevents contamination of the pump.



In general, care is to be taken when removing crating, coverings, and strapping in order not to damage any auxiliary equipment and/or the paint finish.



If a pump and motor is shipped assembled, then care must be taken not to lift the unit from the packaging in such a way to allow the unit to “bend”. This will likely cause damage to the interconnector.

4.2 Transportation

	 CAUTION
	A crane must be used for all pump sets weighing more than 23 kg (50 lb). Fully trained personnel must carry out lifting, in accordance with local regulations.

Sling, ropes and other lifting gear should be positioned where they cannot slip and where a balanced lift is obtained. Care must be taken to ensure safe handling of the equipment during all transportation and handling.

	 CAUTION
	Do not use eye bolts to lift pump, motor and assemblies as they can potentially damage machined alignment surfaces.

	 CAUTION
	Care must be taken to lift components or assemblies above the centre of gravity to prevent the unit from flipping

4.2.1 Lifting

	<p>CAUTION</p> <p>Due to the danger of sagging, pump units that exceed the permissible length must be supported by an auxiliary carrier (U or H carrier) when lifted into the vertical position. This carrier may only be removed after the pump unit is hanging vertically from the crane or lifting block. (See figure 2-1.) When a carrier is not available, it is recommended that the pump and motor be lifted using a strongback beam. If lifting the motor separately, use two lifting points consisting of the motor top flange and lower end of the stator body.</p>
---	--

Figure 2-1



When assessing the diameter of the unit, use the smaller size from the pump and motor. This can be found on the rating plate or the data sheet.

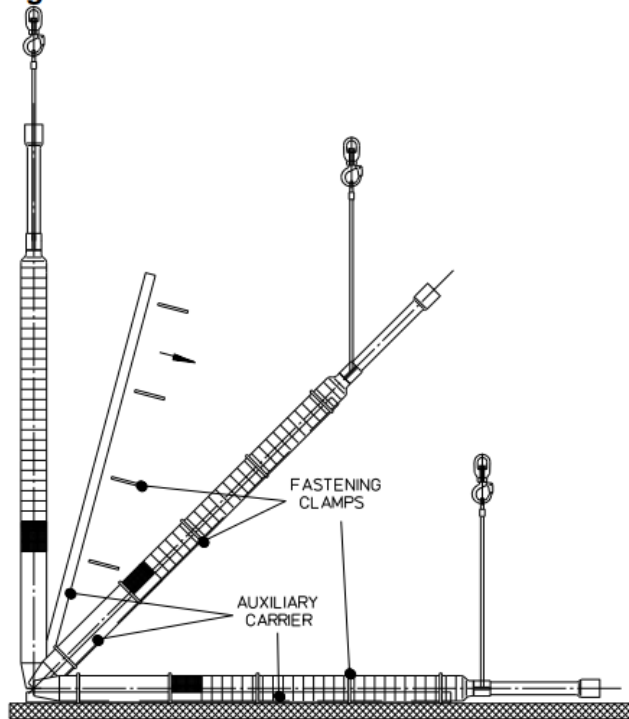

Table 2-1



Rated diameter	Permissible length
6 in. (152 mm)	3.3 m (10.8 ft)
8 in. (203 mm)	3.5 m (11.5 ft)
10 in. (254 mm)	4.4 m (14.4 ft)
12 in. (305 mm)	4.7 m (15.4 ft)

Under no circumstances must the power cables be used for lifting or moving the motor.

4.3 Storage

4.3.1 General remarks

	 CAUTION
	<p><i>Store the pump and motor vertically and secured properly to prevent their tipping over in a clean, dry location away from vibration. Leave piping connection covers in place to keep dirt and other foreign material out of pump casing.</i></p>

	 CAUTION
	<p><i>Submersible pump units need special storage conditions. For functional reasons some inner parts (e.g. the stator and rotor plates) cannot be produced from corrosion resistant materials and are therefore sensitive to any type of air humidity.</i></p>

All units may basically be stored either in a filled or unfilled condition; however, these two types of storage require different treatment of the unit.

The leads of the power cables must be protected from moisture and sunlight. Ensure that the power cables and, if applicable, the signal cables are not bent during storage.

Requirements for the storage area

- a) The storage area must be well ventilated.
- b) Air humidity should be in a range of 40 to 60%.
- c) Temperatures: +50 to -25 °C (+122 to -13 °F) for units with unfilled motors +50 to -15 °C (+122 °F to +5 °F) for units with filled motors.
- d) For temperatures down to -15°C, (+5 °F) see the guidelines in the instructions for filling submersible pump motors in section 5.2.3, Antifreeze.

4.3.2 Storing for up to four weeks

No other special arrangements are required.

4.3.3 Storing between one and 24 months

For storage between one and 24 months, it is recommended that the shaft of the unit be turned at intervals of approximately 8 weeks. On pump units where this is not possible, the pump and motor must be separated.

4.3.4 Storing for over 24 months

For long term storage over 24 months, it is recommended to rotate the shaft at 8-week intervals and check the motor insulation resistance at least yearly. Record the date and insulation resistance reading. If insulation resistance deteriorates over this period, then it is recommended the motor be replaced or serviced if possible. If possible, store the motors under water to ensure the components do not dry out or drain and lead to corrosion damage.

4.3.5 Inspection before storage

- a) Inspect the preservative coating/painted surfaces on the various parts. Touch up the areas, if necessary.
- b) Inspect all covers over pump openings and piping connections. If found damaged, remove the covers and inspect interiors of the opening for any deposits of foreign materials or water.
- c) If necessary, clean and preserve the interior parts as noted above to restore the parts to the "as shipped" condition. Replace covers and fasten securely.
- d) Exercise caution with pumps exposed to weather. Containers are not leak proof. Parts may be coated with a residual amount of protective coating, which will wash away if exposed to elements.

4.3.6 Recycling and end of product life

At the end of the service life of the product or its parts, the relevant materials and parts should be recycled or disposed of using an environmentally acceptable method according to local regulations. If the product contains substances that are harmful to the environment, these should be removed and disposed of in accordance with current regulations. These requirements include the liquids in the motor.





Make sure that hazardous substances are disposed of safely and that the correct personal protective equipment is used. The safety specifications must be in accordance with the current regulations at all times.

5 Installation

This equipment is intended for installation and operation in vertical orientation only. Flowserve should be contacted to ensure the equipment is suitable for any installation in a horizontal application.

5.1 Inspection and preparation

Conduct an inspection of the equipment and the facility where it is to be installed. If any deterioration of equipment is noticed it is recommended the equipment be repaired or replaced to ensure reliable system operation.

	 CAUTION
	<i>Take special care when handling the pump unit. Make certain that it does not hit against walls, steel structures or floors etc.</i>

5.1.1 Insulation Resistance Testing

This test will be conducted on a number of different steps during installation or storage inspection of the motor, cable, or other electrical components. Only qualified personnel should conduct this test and interpret the results.

For conducting the insulation resistance test, use a megohmmeter rated for 500 VDC

Attach insulation resistance tester return lead to a suitable ground path for the test. This may be the motor housing, metal well casing, or ground wire (if so constructed). Set the voltage test level at 500 VDC

Attach other lead to device to be tested (motor, cable, other) at the copper terminal or wire conductor.

Start test and after 60 seconds have elapsed record the insulation resistance value in MΩ.

Disengage power from the insulation resistance tester and ensure any residual voltage is discharged through a shorting lead for at least 4 minutes or 4X the length of time energized

If possible, record the temperature of the motor and/or the environment. Insulation resistance varies with temperature, so consideration of ambient temperature is required when comparing readings in different environments or times.

Logging of readings for future reference and comparison can be a useful method to evaluate the change in insulation condition over time.



5.2 Installation

5.2.1 Equipment, tools, and materials required for installation of unassembled pumps

The following list covers the principal tools/items required for installation.

- a) Potable water optionally with antifreeze if there is a risk of freezing (ref section 5.2.3)
- b) Cranes or rigs capable of hoisting and lowering the pump and/or motor and the tubing string and cable.
- c) Power cables and, if applicable, signal cables are fixed to the tubing by means of cable clamps, ties, or banding. Cable sheaves or guides may be needed to ensure there is no damage as the cable enters the well.
- d) Centralizers for preventing cable damage during installation in tight wells or wells deviating from vertical
- e) Submersible cable splicing materials to connect the power cable to the motor leads. See data sheet for lead wire details.
- f) Tubing and associated tooling required for installation.
- g) General purpose hand tools, pipe wrenches, end wrenches, socket set, screwdrivers, Allen wrenches, wire brush, scraper and fine emery cloth.
- h) Thread sealing compound designed for stainless steel and light machinery oil.

Note: Parts and accessories may be placed inside shipping containers or attached to skids in individual packages. Inspect all containers, crates and skids for attached parts before discarding.

5.2.2 General advice for installation

Required minimum flow velocity past the motor is 0.5 m/s (1.5 ft/s). For applications requiring lower flow velocities, Flowserve should be contacted for application review and approval to operate at the lower velocity. Generally, Flowserve will require a flow shroud to ensure velocity is above the minimum.

Note: Contact your Flowserve representative if you require assistance determining the flow velocity in your application.

The following criteria must be considered to determine the installation depth:



- *Location of the motor in the well above the well casing perforations so that an adequate motor cooling flow is guaranteed along the external motor surface. Consult the Drilling Contractor to provide the recommended pump setting and ensure minimum flow velocity past the motor.*
- *If there is insufficient flow velocity in your application and/or the flow will be coming from above the pump, then a flow inducing shroud as pictured below will be required. The non-closed end of the shroud should be fixed to the center of the motor in the shroud without causing deformation of the motor or pump housing. Failure to install a shroud when required can cause premature failure and voids the warranty.*

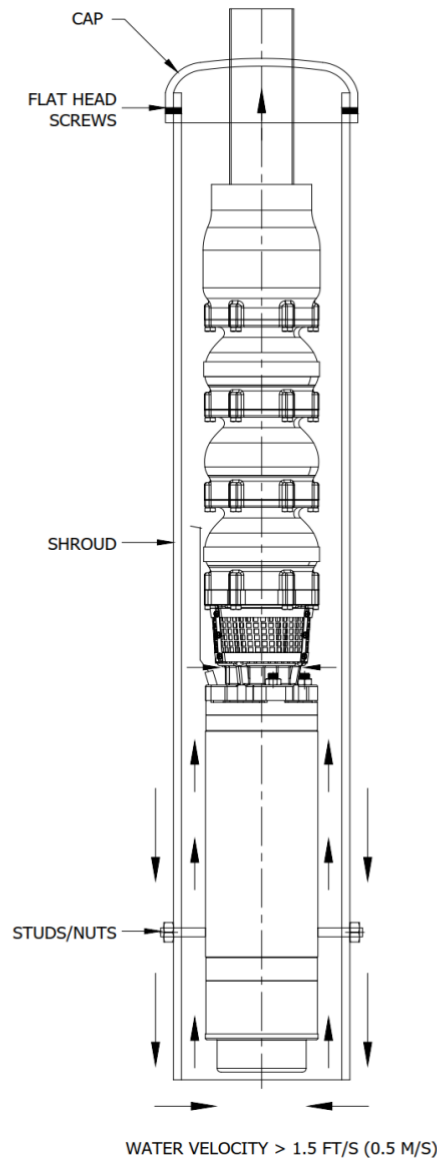

- Your motor is designed to operate in applications with water temperatures of 122°F (50°C) or less. Please contact your Flowserve representative if the application temperature is hotter for recommendations. The operator is responsible for ensuring that the specified maximum liquid temperature is not exceeded.







- The pump must have adequate depth in the well to ensure adequate submergence including when the water level draws down after pumping commences.

- In addition to pump depth, the cable splice to the motor leads should be submerged to ensure adequate cooling of the leads.
- A dynamic water level above the interconnect, cable splice, motor, and pump NPSH requirements is required. (See pump characteristic curve.)
- Flow rate. (See pump characteristic curve.)

	 CAUTION
	<p>Regardless of the above, the pump unit should be installed above the well screen whenever possible, to avoid foreign matter being drawn directly into the pump inlet, and to ensure that there is adequate water flowing across the motor to assist heat transfer. If this is not possible a flow shroud should be provided to induce the flow of water over the motor.</p>

	 CAUTION
	<p>Pump units can only be operated with a fully filled and submersible motor. The liquid level of the motor must always be checked before installation and, if necessary, filled according to the instructions in this manual. Failure to do so could damage the motor during operation.</p>

	 CAUTION
	<p>If a flexible hose or tubing is used instead of steel pipes to suspend the pump in the well, the system will twist against the direction of rotation of the motor when it is started. In this case, the power cable (and, if provided, the signal cable) fastened to the hose or tubing would also twist and tighten. To prevent the cables being pulled out of their junction boxes, they should not be laid parallel to the riser hose but wound around it in the opposite direction to the rotation of the motor. The number of turns required will depend on the length and stiffness of the riser hose line and the locked rotor torque of the motor. The exact twisting characteristics will need to be requested from the hose or tubing manufacturer.</p>

	 CAUTION
	<p>Under no circumstances must the power cables be used for lifting or moving the motor.</p>



5.2.3 Antifreeze

General Information about Filling.

The General information about filling in this section applies to all motor types, unless stated otherwise in the individual descriptions.

Motors are usually supplied with factory-installed water inside. This water has been mixed with antifreeze, which allows the motor to be stored in temperatures down to -30 deg. C. or -22 deg. F. If motors are to be transported or stored below these temperatures the water/antifreeze mixture must be drained from the motor. (We recommend that the motor be clearly tagged to alert future users that the motor has been drained. If a motor must be filled or topped up with a mixture of water and antifreeze, this must be prepared in a clean container before filling the motor.

Verify that the Motor is full of water/antifreeze mixture or clean water prior to Installation. FAILURE TO ENSURE THAT THE MOTOR IS FULL OF WATER PRIOR TO OPERATION WILL VOID ANY WARRANTY CLAIMS. Ensure all filling plugs, drain plugs, cable connections, and mounting bolts are tight.

In the case of freezing environments (shipping and/or storage) the motors can be filled with a mixture of water and antifreeze. The mixing ratio is typically 30% propylene glycol and 70% water. Other ratios can be used if protection is required at temperatures less than 5°F (-15°C).

The antifreeze should be a food grade Propylene Glycol such as Dowfrost HD.

In most cases, the motors will be delivered with pre-filled water and will just require topping off to ensure the motor is completely filled so that no air is trapped in the motor.

	CAUTION
	<i>Never use distilled water</i>

Topping off pre-filled motors

Topping off pre-filled motors can be done with potable water without antifreeze if the quantity of topping up liquid is relatively small (1-2%).

Filling of motors that have been drained or never filled

Position the motor horizontally. Remove the filling hole screw/plug located near the top end of the motor and the venting hole screw/plug located at the lower end of the motor. Pour fluid into the motor until water flows out of the vent hole and is bubble free. Replace the venting hole screw/plug. The filling hole is typically a R1/4"



Position the motor vertically. Continue filling the motor through the filling connection. In order to ensure complete filling and eliminate residual air from the motor, the vertical filling process should be repeated after 5 minutes. Plug the filling hole with the screw/plug.

Filling pressure

To avoid damage to the shaft seal and motor, the filling pressure at the inlet of the filling connection should not exceed 8 PSI (0.5 bar). Most household water supply systems can exceed this pressure, so caution should be used and filling directly from a water supply system is not recommended.

Make sure the diaphragm opening at the bottom of the motor is open and not blocked with mud or dirt.

The supplier must be advised if horizontal operation is required prior to installation.

Checks before installation

The following checks should be made before starting actual installation.

- a) The water chemistry should be within the following range
 - PH 6.5-8
 - Max chlorine 500 PPM
 - Max Sulphur acid 15 PPM
 - Max fluorine 0.8 PPM
- b) Verify that the wellhead foundation is poured and cured, if made of concrete. The total load on the wellhead foundation will consist of the motor, pump bowl assembly, riser tubing (full of water), wellhead assembly and power cable.
- c) Verify that open discharge run-off, ditch, etc. for flushing out well and testing unit is prepared.
- d) Verify that a log of the well recording depth, straightness, casing variations, standing water level, rated capacity, pumping level, etc., is at the installation site.
- e) Some wells taper to smaller diameters at lower depths. Ensure that the well diameter is large enough down to the installation depth so that the pumping unit can be fitted without difficulties.
- f) Check all pump connections (bolts, nuts etc.) for any shipping and handling related problems.
- g) Before beginning installation, check the dependability of auxiliary equipment, as well as comparing the information on the data sheet with that on the rating plate on the motor.
- h) The motor controller should be capable and set to shut the motor down within 3 seconds if the motor experienced locked rotor or starting current conditions.
- i) The maximum permissible supply fluctuations can be
 - i. +/-10% voltage at the rated frequency
 - ii. +/-5% frequency at the rated voltage
 - iii. Combined variation of voltage and frequency of +/-10% (sum of absolute values) provided the frequency variation does not exceed +/-5% of rated frequency
- j) Before installing, the insulation resistance of the motor alone must be measured. (See section 5.1.1 for instructions). The insulation resistance for the motor should be as indicated in the table 5.2.4

Condition of the Motor and Power Cable	Minimum Insulation Resistance Value (MΩ) at 40°C
New motor or used motor in good condition which is not installed, rated less than 1000 V (Ref NEMA MG1 20.18.1 and IEEE 43, 12.3)	1000
New motor or used motor in good condition with cable installed	50



Table 5.2.4

In the event the insulation resistance value is lower than the minimum after the cable is installed, then the electrical insulation is potentially compromised. Check splices, connections, cable condition for damage or leakage. Correct the damage or replace the component as needed

Connection of Power Cables

The motor leads must be connected to the power cable securely and in a manner that will ensure water tight sealing of the connection to ensure electrical integrity. Failure to make this connection properly will lead to premature failure of the system. Flowserve recommends this work be done by professionals only who have been trained in the procedures required to achieve a successful and reliable submersible splice. Splice kits can be obtained, and the kit should provide the procedure for completing the splice.

Meg Test post splicing and prior to install and confirm the insulation resistance is at least the value indicated in Table 5.2.4

	 CAUTION
	<p>When pump units are installed in narrow or deviated wells, the risers, whether steel pipes, tubing, or hose lines, will need to be centralized to prevent them from touching the wall of the well which could cause damage to any cables fastened to them.</p>

5.2.4 Assembly of submersible motor pumps before installation

If your pump and motor has come preassembled to each other, this section may be skipped. Proceed to section 5.5

Submersible motor pump units that are delivered in sub-assemblies must be assembled during or before installation. For assembly of these submersible motor pump units the specific installation instructions must be requested from the manufacturer if they have not been delivered with the unit. The following provides general guidelines but may require modification dependent on the pump and motor to be installed.

Note:

- *Check the motor shaft size against the coupling bore to ensure proper fit.*
- *Verify the motor shaft turns freely with little resistance except from the mechanical seal. The initial rotation may be difficult until the thrust bearing is freed.*
- *The coupling should be a tight sliding fit on the shaft. Do not hammer or force the coupling on the shaft as this could damage your motor or pump.*

5.3 Impeller Lift Requirement

If the pump was not supplied assembled to the motor, then proper impeller lift is required. This is usually accomplished by the motor shaft lifting the pump shaft from its lowest position

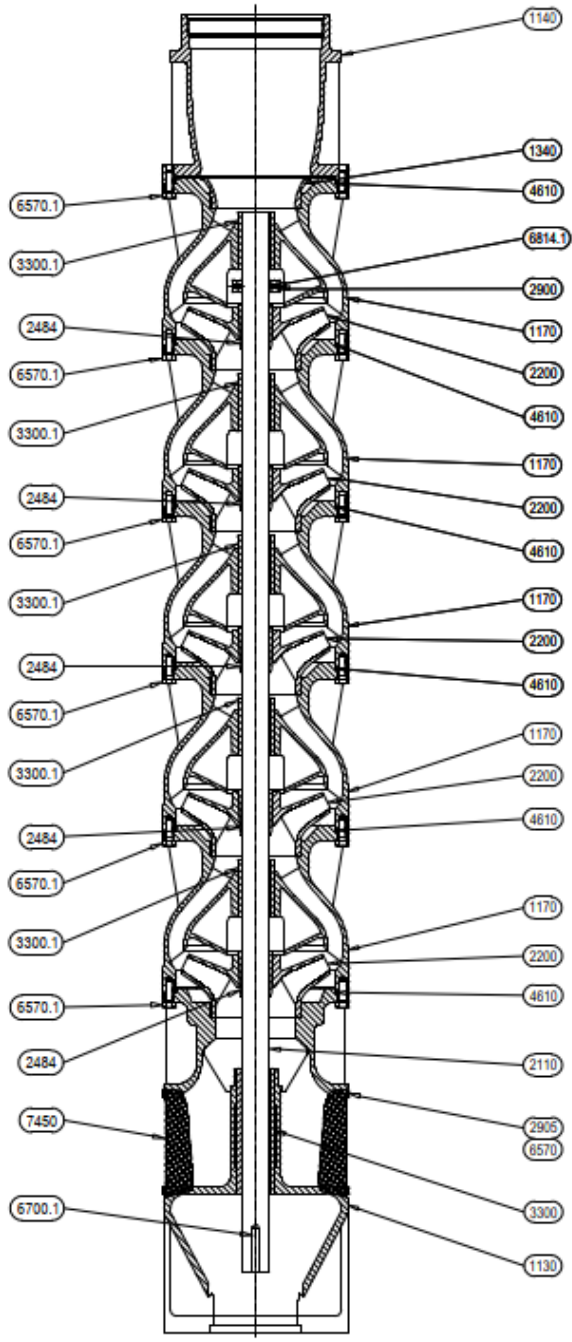

Fig 5.4 Typical Cross-sectional drawing



REF. NO.	DESCRIPTION
1130	INTERCONNECTOR
1140	ADAPTER BOWL
1170	BOWL
1340	RING FLOW
1370	SURFACE PLATE
2110	SHAFT PUMP SBM
2200	IMPELLER
2484	COLLET DRIVE
2900	DISK UP-THRUST
2905	WASHER FLAT
3300	BEARING SLEEVE
3300.1	BEARING SLEEVE
4610	O RING
6541	WASHER LOCK HELICAL SPRING
6570	SCREW CAP HEX HD
6570.1	SCREW CAP HEX HD
6572	STUD
6581	NUT HEX FINISHED
6700.1	KEY SQUARE
6814	SOCKET HEAD CAP SCREWS
6814.1	SOCKET HEAD CAP SCREWS
7450	COUPLING GUARD

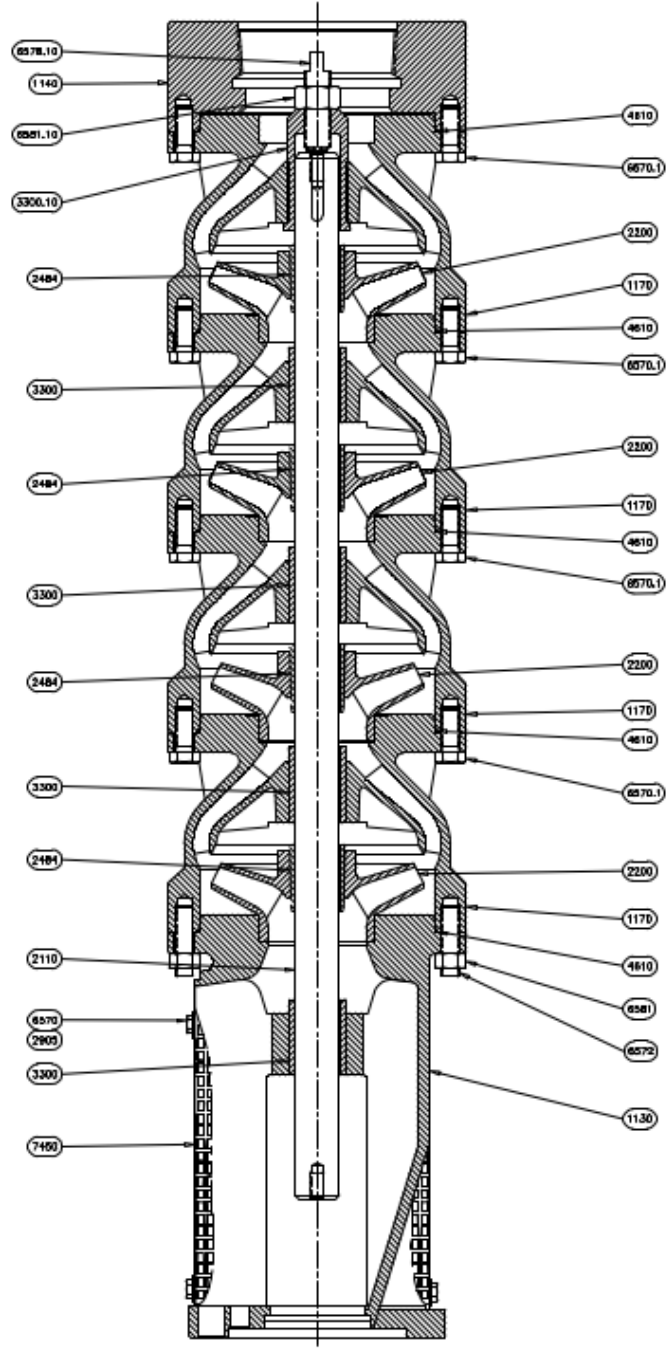

Figure 3: Typical Cross-sectional drawing



REF. NO.	DESCRIPTION
1130	INTERCONNECTOR
1140	CASE TOP FLANGE
1170	BOWL
2110	SHAFT PUMP SBM
2200	IMPELLER
2484	COLLET DRIVE
2905	WASHER FLAT
3300	BEARING SLEEVE
4610	O RING
6570	SCREW CAP HEX HD
6570.1	SCREW CAP HEX HD
6572	STUD
6581	NUT HEX FINISHED
7010	COUPLING SUBMERSIBLE
7450	COUPLING GUARD
3300.10	HOLDER BRG UP
6578.10	ROD UP-THR

5.4 Connecting Pump to Motor

Note: Pump and motor shaft may be keyed or splined according to NEMA MG1 standards. Generally, 6" and 8" motors will have a splined shaft and 10" motors will be keyed. If keyed, ensure keys are installed with coupling.

- a) Assemble coupling (7000) on driver shaft (2100) (if not installed earlier).
- b) Install set screw (6569.1) into Coupling (7000) to lock the position on the Motor shaft. Check motor direction of rotation using a phase rotation meter.
- c) Measure and write down pump manufacturer recommended impeller setting for final confirmation.
- d) Verify impeller lift meets pump manufacturer recommended impeller setting.
- e) Smaller pumps may be coupled to motor horizontally or vertically. Larger pumps requiring a crane or other lifting device should be installed on to the motor vertically. This operation can be done over the well.
- f) Ensure shafts, coupling, interconnect flange (1340), and motor flange are clean and free of debris. *Note: A gasket is not required here. Installation with a gasket will cause improper pump and motor alignment and early failure.*
- g) Lift pump above motor. Center pump over motor.



- h) Lower pump to motor and secure pump on to motor and coupling (with key (6742) if appropriate). Ensure the pump shaft easily slides into the coupling.
- i) Bolt pump to motor.
- j) Install set screw(s) (6569.2) in coupling (7700) to secure the pump shaft (2100) in the event of up thrust.

5.5 Installation after pump and motor have been assembled together

Mount the first length of pipe, which should not be longer than 1 m (39 in.), onto the assembled pump unit. This piece is usually threaded into the pump discharge or the top of the non-return valve. Adequate torque should be used to prevent unthreading during starting or operation. For threaded pipe connections, it is recommended to use a permanent thread locking compound to ensure threads are not loosened on the short section of column pipe, next to top case or top case flange, such as Loctite 277 (Red) & Primer T or equal. For remaining column pipe threads, use a pipe thread compound that is capable of lubricating and sealing. Please note, the motor could turn in either direction. The amount of torque from the motor could be as high as indicated below:

Nameplate HP X 6 = Motor Torque (ft-lbs.) for 2 pole motors

Nameplate HP X 12 = Motor Torque (ft-lbs.) for 4 pole motors

Nameplate kW X 6 = Motor Torque (N-m) for 2 pole motors



Nameplate kW X 12 = Motor Torque (N-m) for 4 pole motors

The support tubing and connections should be able to (at a minimum) handle repeated applications of this torque value in either direction. Torque arrestors are available for certain size motors if desired. Fasten the power cables, control lines and instrument. leads (if any) with cable clamps, clips, or banding onto the pipe at 10 ft (3 m) intervals.

- a) When lowering the unit, ensure the power cable is neither squeezed nor scraped. To protect the power cables, we recommend that the well head is lined with a rubber sheet at the entry point of the power/ signal cable into the well pipe and it is fed into the well shaft using a cable roller. (See below figures).
- b) During lowering, the unit must always hang freely and must not become wedged in the well shaft. Always ensure that the pump/motor/tubing string can be rotated freely in the well during the entire installation. Attach a cable clip every 3 m (approx. 10 ft.) of pipe length to ensure support of the cable.



5.5.1 Riser pipe with threaded pipe

If riser pipe does not have threaded pipe, proceed to section 5.5.2

	 CAUTION
	<p><i>The instructions in this section are meant as general guidelines because the specific details involved vary from location to location. For specific guidelines, refer to an experienced submersible pump installer or your riser pipe supplier.</i></p>

Connect a lifting clamp underneath the pipe coupling of the threaded riser pipe and lift the complete pump unit with a suitable hoist.

- Lower the pump unit into the well as far as the installation clamp mounted underneath the coupling of the riser pipe.
- Fasten the power cables and, if necessary, the control lines and/or instrument leads with cable clips onto the riser pipe.
- Lower the unit and rest it on the well rim flange.

	 CAUTION
	<p><i>Do not let the pump unit slip through the installation clamp.</i></p>

- Remove the lifting clamp and attach it to the next riser pipe and connect this to the pipe already installed.
- Lift the unit and remove the resting supporting clamp.
- Install the remaining riser pipes as described above.
- Finally mount the wellhead support plate well head gasket onto the last riser pipe. Feed the power cables and, if necessary, the control lines and/or instrument leads through the corresponding holes in the wellhead support plate and connect them to the junction box or control panel.



5.5.2 Other riser pipe designs

If an alternative riser pipe design is being used such as flange pipe, composite pipe or other, consult pipe/tubing supplier for guidelines for installation.

6 Commissioning

6.1 Safety instructions

NOTE Before commissioning, operation or shutdown of the pumping unit, read Section 2 “Safety Information”

	 CAUTION
<p><i>These operations must be carried out by fully qualified personnel. Turn off power supply for safety while pump commissioning is in progress.</i></p> <p><i>The pumping unit may only be operated</i></p> <ul style="list-style-type: none"> • <i>By trained personnel</i> • <i>In a completely assembled condition</i> • <i>Fully filled and submerged</i> 	

 **WARNING**

CATASTROPHIC OR FATAL ELECTRIC SHOCK MAY RESULT FROM FAILURE TO CONNECT THE MOTOR CONTROL ENCLOSURE, METAL PLUMBING, AND ALL OTHER METAL NEAR THE MOTOR OR CABLE, TO THE POWER SUPPLY GROUND TERMINAL USING WIRE NO SMALLER THAN THE CABLE WIRES. TO REDUCE THE RISK OF ELECTRICAL SHOCK, DISCONNECT POWER BEFORE WORKING ON OR AROUND THE WATER SYSTEM.



DO NOT USE IN SWIMMING AREAS

THIS EQUIPMENT IS INTENDED FOR INSTALLATION BY TECHNICALLY QUALIFIED PERSONNEL. FAILURE TO INSTALL IN COMPLIANCE WITH NATIONAL AND LOCAL CODES, AND FLOWSERVE RECOMMENDATIONS, MAY RESULT IN ELECTRIC SHOCK OR FIRE HAZARD, UNSATISFACTORY PERFORMANCE AND EQUIPMENT FAILURE.

6.2 General notes

Details concerning the electrical switchgear must be taken from the Operating Instructions from the control panel manufacturer.

6.3 Connection to starter/controller

	 CAUTION
<p><i>The work conducted here can present electrical hazards and risks. Refer to the starter/controller IOM for specific details. Instructions here are offered as general guidelines and should not take precedence over local regulations.</i></p>	

Prior to connecting the cable to the panel, the cable and motor insulation resistance should be checked and be at least as specified in table 5.2.4

Connection to the starter/controller should be handled by a qualified electrician and by following the directions in the manual for the starter/control panel. Local electrical codes and regulations should be followed.



6.4 Starting the pump

6.4.1 Pre-starting checks



- 1) Before starting the Pump, the following checks should be made.
- 2) Check that all piping connections are tight.
- 3) Ensure all downstream equipment is ready to receive water or ensure another means of handling the water has been prepared.
- 4) Check all bolting connections for tightness
- 5) Confirm all electrical connections are good.
- 6) Confirm incoming voltage is correct. Do not attempt to start the motor if the voltage is less than 95% of nameplate.
- 7) For motor pumping units working with inverters (also known as Variable speed drive (VSD), Variable Frequency Drive (VFD), Adjustable Speed Drive (ASD), or Adjustable Frequency Drive (AFD)), care must be taken to ensure proper set up and limits are established. (See guidelines in Inverter Section)
 - a. A constant ratio of V/Hz must be maintained (7.67 for 460 V, 60 Hz and 380 V, 50 Hz motors)
 - b. Motor should be ramped up to at least 70% speed within 3 sec
 - c. Dynamic braking options on the inverter should be disabled

Operational Limits

- NOTE: Never let the submersible motor pump run dry.
- Starting, including for test purposes, is never allowed if the pump is not submerged.
- For the minimum submersion depth in the delivery medium, refer to the Section 9 "Technical Data" or ask Flowserve.
- Failure to follow these restrictions can cause the following dangers:
 - Failure of important system functions
 - Failure of prescribed methods for maintenance and upkeep
 - Danger to persons due to electrical, mechanical or chemical impact
 - Danger to the environment by leakage when delivering hazardous media

	 CAUTION
	Operation with a flow rate that is above rated flows can cause motor overload and cavitation in the pump. Low flow rates can cause shortened service life of the pump, overheating of the pump and motor, instability, cavitation and vibration.

- The duty-point for which the pump unit has been designed can be found in Section 9 “Technical Data”
- To avoid overheating the motor, a pump must never be operated for more than 1 minute against a closed discharge valve.
 - Depending on your pump type, as the empty piping is being filled, the ammeter may show a higher current than in the data sheet even after the starting current has decayed during the initial start. This higher current may be due to high flow in the pump. If this condition continues after all piping is full, then the control valve may need to be adjusted to a flow rate that will not overload the motor.
 - Excessive flow can cause motor overload and excessive production of sand from the well. These conditions could cause premature wear on your submersible pump and motor unit.
 - After the unit has operated for a period, it is possible that a minimal readjustment of the control valve and motor controller may be required, due to changing operating conditions, for example by the drawdown of the water level.

	 CAUTION
	Motor protection settings that do not follow these guidelines could cause unsafe conditions or premature failure of your equipment. Please note, data sheet may have been supplied with quote or may be shipped with equipment. If required, consult your Flowserve representative for setting these limitations.

Control setting	Minimum	Maximum
Flow rate	See data sheet minimum continuous flow	See data sheet maximum flow on curve
Voltage	See data sheet	See data sheet
Voltage Imbalance		See 5.2.4
Current	Typically set 10% below minimum load current	Typically set at no more than full load current X SF. Prefer setting at 10% over normal operating current.
Current Imbalance		10%
Starts/hour		See 7.1.1 Recommend minimum possible



Table 6.4.1 Control Settings

- For monitoring the water level in the well and in the header tank, we recommend water level detectors or water level measuring units. Operation of the submersible pumping unit without adequate water level will cause early failure and void the warranty.



6.4.2 First-time start-up of the pump

Do not start until the pump unit has been fully installed and all piping has been connected downstream as far as the control valve.

- 1) Prior to connection to starter, measure insulation resistance (leads-to-ground) with power turned off and motor turned off to ascertain that no short circuits are present.



	 CAUTION
	Do not attempt to start the pumping unit with an insulation resistance reading of less than indicated in Table 5.2.4

- 2) Verify that balanced three-phase voltage is supplied and is at least 95% of nameplate voltage.



	 CAUTION
	Never attempt to run the pumping unit with an unbalanced voltage between two leads. An imbalance between two leads can cause 6-10 times of imbalances in an amperage and the resultant temperature increase means a decrease in motor life. Any voltage imbalance more than 1% requires the motor be de-rated as specified in NEMA MG1.

An improperly sized engine driven generator can be very detrimental. Ensure proper sizing is achieved by consulting with the generator supplier.

- 3) Partially close the pump discharge valve.
- 4) Start the motor and record the current after the starting current has dropped



	 CAUTION
	Do not run the Pump for more than 1 minute with discharge valve closed.

When the direction of rotation is incorrect, the pump will have no water production or extremely reduced water production. If current is lower than expected, rotation is not correct.

	 CAUTION
	<p>The unit must not be operated for longer than three minutes in the reverse direction. In the case of operating in the wrong direction</p> <ul style="list-style-type: none"> • press STOP • turn off all power and confirm power is not being delivered to the cable junction box or terminals • exchange the motor power cable leads from two phases with one another in the control panel. • Mark the leads so that they can always be placed correctly any time they are removed.

- 5) After verifying proper rotation, open the discharge valve to the desired flow rate without exceeding the motor full load current



Recheck the current, which should be near full load current if it is rotating in the correct direction and the flow rate is near rated conditions.

	 CAUTION
	<p>If a circuit breaker trips, always correct the issue causing the trip prior to restart. Wait at least 10 minutes before resetting.</p>

During first-time start-up, take notice of the following:

- a) When motor is started, it should attain full speed within 3 seconds.

If after this period the line current is still high (over twice normal value), the pumping unit is not attaining the full speed.

	 CAUTION
	<p>In the event the pumping unit does not attain the full speed, stop the pumping unit and do not attempt to restart it until the problem is found and corrected.</p>



During normal operation, the current must not exceed the motor name plate value.



- 6) Measure the line voltage between phases while the pumping unit is pumping.
The readings obtained should not be more than 10 % above or below the rated motor voltage.
- 7) In case of malfunction, stop the pumping unit and refer to Section 8 "Trouble Shooting Guide ".

7 Operation



7.1 Normal Operation

7.1.1 Normal start-up of the pump



	 CAUTION
	If maintenance has been performed, follow Section 6.4.2 "First-time start-up of the pump".

	 CAUTION
	NEVER RUN THE PUMP DRY

- 1) Verify that the control panel door is closed.
- 2) Verify that balanced three-phase voltage is supplied by taking readings with the line volt-meter and using the voltmeter selector switch.



	 CAUTION
	Never attempt to run the pumping unit with an unbalanced voltage between two leads.

- 3) Start the pumping unit.
- 4) Verify that the pump motor comes up to speed within 3 seconds as indicated by normal readings of current, voltage, head and flow.
- 5) If one of the following conditions occurs
 - a) current exceeds the rated value of the amperage or
 - b) voltage varies + 10 % or - 10 % from the rated value or
 - c) head and flow are abnormal
 then stop the pumping unit and refer to Section 9 "Trouble shoot Guide".
 Submersible pumps serve to transport water under the operating conditions described in the following:

	 CAUTION
	<p>DO NOT RUN THE PUMP AT ABNORMALLY HIGH OR LOW FLOW RATES</p> <p>Operating at a flow rate higher than normal or at a flow rate with no back pressure on the pump may overload the motor and cause cavitation. Low flow rates may cause a reduction in pump/bearing life, overheating of the pump, instability and cavitation/vibration.</p>

7.1.2 Normal operating conditions

- a) Temperature monitoring if provided should follow requirements in section 3.5
- b) Sand and other abrasives can damage the pump and motor components and steps may be required to eliminate or reduce the abrasives in the water.
- c) Water velocity along motor surface: see table 5.2.2
- d) No impurities that could lead to deposits and blockages within the pump or to deposits on the motor surface.
- e) No water-hammer
- f) Maximum 1-minute operation against closed discharge control valve.
- g) Operation within prescribed voltage tolerances, see section 5.2.2
- h) Permissible operational range: unless otherwise stated, 50 to 120 % of the best efficiency point (BEP)
- i) Correctly selected and adjusted motor protection.
- j) Observation of the maximum permissible number of starts per hour

	 CAUTION
<p>At higher ambient temperatures and/or lower flow velocities on the external motor surfaces, or if there is risk of clogging, special measures for heat dissipation are required. This must be checked with the manufacturer by indicating the ambient conditions. In this case the suitability of the unit for its planned application must be confirmed by the manufacturer.</p>	

- Water level

A well should always be provided with a means for determining the static water level, and pumping level. A good airline, with depth gage, is generally the simplest and most practical.

For continuous monitoring of the water level in the well, we recommend water level detectors or water level measuring units.

- Sand

When a pumping unit is first started, a new well may produce considerable amounts of sand, despite the fact it has been sand pumped after drilling.

The discharge flow rate should be throttled down to a minimum, then gradually opened to full discharge as the sand disappears.

This operation may last from a matter of minutes to several days or longer.

If the sand flow shows no signs of stopping

- a) rework the well to screen out the sand (contact your well driller),
- b) install a pumping unit with a capacity smaller than that of the currently installed unit.

 CAUTION
--



Prior to installation, the well driller should ensure correct well development has taken place to prevent pumping sand. Continued sand pumping will result in increased pump wear which in turn will show up as increased efficiency loss. Too great a wear will ruin the pump beyond the repair stage and possibly have serious effects on the motor.

Some wells will always produce a small amount of sand at start-up. Therefore, it may be necessary to bypass or trap out this first flow at each start-up, particularly if a closed piping system is used.

When a pumping unit is known to be installed near the bottom of a well, close monitoring should be made to ensure sure the well does not sand-up (fill in) around the motor.

Sand-up may occur without any noticeable effect in pumping or motor operation. However, the motor is dependent on adequate cooling from water, and any sand around it would eventually create overheating, resulting in motor overheating and failure.

If this problem cannot be cured by well work, contact Flowserve for devices that can be added to the pumping unit to prevent its sanding up.

Hydro-pneumatic pressure system

If the pumping unit is coupled into a hydro-pneumatic pressure system, the set-up must be designed so that the pumping unit

- does not get "water-logged" (loss of air through water absorption without replacement)
- and does not receive too much air at each start-up.

7.1.3 Motor operation

- Always check the motor insulation resistance (megger) before resetting a tripped circuit breaker.
- Wait 15 minutes before restarting the motor.
- Breaking suction due to inadequate water level in the well can cause pump and motor damage and thus renders warranty void.
- Inadequate power supply can cause damage to the motor which renders warranty void.



A time delay must be installed when any type of automatic system is used to prevent starting of the motor while it is spinning backwards due to riser pipe drain back through the pump.

- Even if a check valve is supplied, the timer delay may be necessary if the check valve is prevented from fully functioning (for example due to debris or corrosion)

- A 3-minute time delay is usually adequate. This provides a safety measure in the event a failure in the automatic control system creates a rapid recycle series. It also provides time for the rotating element of pump and motor to stop, after reverse rotation due to vertical riser pipe drain-back.
- A pumping unit should not be run at closed valve for more than 1 minute as all the energy supplied is then dissipated as heat. This condition can raise the water temperature to boiling and create an overheating problem for the motor.
- After the pumping unit has operated for a longer period of time, a minimal readjustment of the motor circuit breaker may be required due to changed operating conditions, e. g. sinking of the water level.
- The motor may be equipped with 1 or 4, PT100s temperature sensors it is strongly recommended that the PT100s are connected to a temperature display device and that 1, or all 4, steady state temperatures are recorded when the motor is commissioned.
- It is recommended that the temperature display unit also has a function which allows temperature protection to be monitored and set for all channels in the following manner: warning at 140° f and shut down at 160° f.
- If there is a warranty inspection the motor must be returned to the original supplier, or Flowserve, with leads and spliced joints intact – and the cable must be cut above the spliced joints.

If the pumping unit has shut-off and the reason cannot be traced to a positive external source:



a) Switch off the motor.

	 CAUTION
	<p>Ensure power is safely disconnected and de-energized. Only qualified electrical personnel should conduct next steps.</p>

b) Disconnect the motor from the main power supply.

c) Disconnect the power cable leads from the starter

d) Measure the insulation resistance of the power cable leads to the ground (the well casing). A low insulation resistance reading is an indicator of a damaged motor or cable.

	 CAUTION
	<p>Never reset a breaker or replace a blown fuse and start a motor without first measuring the insulation resistance of the unit.</p>

7.1.4 Number of starts

Size	Allowable Starts/hour
6"	4
All other motors	6

Table 7.1 Allowable starts



Excessive starting of your submersible pumping unit can result in a shorter life and damage to the equipment. To protect the motor against non-permitted restart, use a timer relay or program the controller accordingly.

7.2 Shut-down

To minimize water-hammer the control valve must be closed before the unit will be switched off. After the valve has been closed the unit must be switched off within 1 minute.

To stop the pump, follow the user instructions for the control panel.

The pump should be started at least monthly and operated for at least 10 minutes to ensure free rotation of the pump and prevent sanding that might lock up the pump.

	 CAUTION
	<p>For prolonged shutdowns and especially when ambient temperatures are likely to drop below freezing point, the piping system must be drained or otherwise protected.</p>



8 Trouble Shooting

The potential issues with pump production are often caused by factors external to the pump motor unit itself. The use of this guide is intended to cover many of the common factors, both internal and external, but it is not possible to cover every potential issue. An experienced pump installer and operator may need to be consulted to determine the root cause of any issue.

Pump is operating but no water or limited water is produced

The control valve or other valving is closed or partially closed	Open the valve
Motor is operating in the wrong direction	Exchange two phases of the power cable
The water level in the well is too shallow	Increase the installation depth. Close the valve to decrease flow and prevent the water level from dropping as quickly.
Incorrectly selected pump	Replace with appropriately sized pump
Leakage in the riser tubing or discharge piping	Repair/replace as needed
The intake strainer is blocked with debris	Remove pump and clean the strainer
Pump or check valve passages are blocked	Remove pump and correct the issue
Motor is turning at a slower speed	Ensure proper voltage is being applied during operation
Pump shaft or coupling is damaged/broken	Remove pump and repair/replace
Pump is worn out	Repair/replace as needed

Pump discharge pressure is low

The water level in the well is too shallow	Increase the installation depth. Close the valve to decrease flow and prevent the water level from dropping as quickly.
Pressure switch is malfunctioning or incorrectly set	Ensure pressure switch functionality
Leakage in the riser tubing or discharge piping	Repair/replace as needed
Pump is worn out	Repair/replace as needed
Pump or check valve passages are blocked	Remove pump and correct the issue

Motor Temperature is high

Motor is overloaded	Shut the unit down and troubleshoot to find the cause
Pump or Motor is Locked	Remove pump and correct the issue Repair/replace as needed
Control settings are set incorrectly	Verify and correct if needed
Motor is operating on two phases	Check controls, fusing, and cable connections

Frequent Starts and Stops Frequently



Settings for level controls are too close to one another	Modify to ensure starting/stopping is limited as required
Pump is oversized for needs	Change pump for smaller flow rate or close valve to reduce flow rate (while ensuring adequate flow remains to cool motor)

Pump Operates Noisily and/or Vibrating

Pump or piping is partially or completely blocked	Diagnose and correct cause
Excessive air or gas in water	Pump intake is too high. Install pump more deeply.
Pump or Motor bearings are damaged	Remove pump and repair/replace pump/motor
Incorrectly selected pump	Replace with appropriately sized pump
Piping flanges/joints are not installed properly	Diagnose and correct cause
Pump is operating outside it's flow range limits	Adjust control valve to ensure flow rate is within the pump's operating range

Pump Does not Operate

No power being supplied	Correct electrical issues with controller and/or power supply
Fuses are blown or breaker is tripped	Diagnose the cause for the trip. Ensure motor has good insulation resistance. Replace fuses/ reset breaker once cause is found and corrected
The control has tripped due to low water level	Confirm the water level and do not start pump until water level is raised. Consider moving pump intake lower to ensure adequate water supply.
Motor or cable has short circuited	Check insulation resistance and pull unit if too low.

Note: In the event the pump or motor needs to be repaired, spare parts should be ordered from Flowserve. Use of non-Flowserve parts could result in numerous risks and non-compliance with safety and performance requirements.



9 Appendix



Flowserve factory contacts:

Flowserve Taneytown
5310 Taneytown Pike
Taneytown, MD 21787
Telephone: +1-410-756-2602

FLOWSERVE REGIONAL SALES OFFICES:

USA and Canada
Flowserve Corporation
5215 North O'Connor Blvd.
Suite 700
Irving, Texas 75039-5421, USA
Telephone: +1-972-443-6500
Fax: +1-972-443-6800

Europe, Middle East, Africa
Flowserve Worthington S.r.l.
Via Rossini 90/92
20033 Desio (Milan), Italy
Telephone: +39-0362-6121
Fax: +39-0362-303-396

Latin America and Caribbean
Flowserve Corporation
6840 Wynnwood Lane
Houston, Texas 77008, USA
Telephone: +1-713-803-4434
Fax: +1-713-803-4497

Asia Pacific
Flowserve Pte. Ltd
10 Tuas Loop
Singapore 637345
Telephone: +65-6771-0600
Fax: +65-6862-2329

Local Flowserve representative:

To find your local Flowserve representative use the Sales Support Locator System found at www.flowserve.com

Flowserve Corporation has established industry leadership in the design and manufacture of its products. When properly selected, this Flowserve product is designed to perform its intended function safely during its useful life. However, the purchaser or user of Flowserve products should be aware that Flowserve product might be used in numerous application under a wide variety of industrial service conditions. Although Flowserve can (and often does) provide general guidelines, it cannot provide specific data and warnings for all possible applications. The purchaser/user should read and understand the User Instructions: Installation Operation Maintenance included with the product, and train its employees and contractors in the safe use of Flowserve products in connection with its application

While the information and specifications contained in this literature are believed to be accurate, they are supplied for informative purpose only and should not be considered certified or as a guaranteed of satisfactory results by reliance thereon. Nothing contained herein is to be construed as a warranty or guarantee, express or implied, regarding any matter with respect to the product. Because Flowserve is continually improving and upgrading its product design, the specifications, dimensions and information contained herein are subject to change without notice. Should any question arise concerning these provisions, the purchaser/user should contact Flowserve Corporation at any one of its worldwide operations or offices.

© 2023 Flowserve Corporation, Irving, Texas, USA. Flowserve is a registered trademark of Flowserve Corporation